

Open System Communication Connectivity Solutions

CM Series Open System Communication Modules support open system architecture by providing a variety of unloaded modules to accept devices from Ortronics® and other industry leading manufacturers. Mounting industry standard communication devices in Wiremold wire and cable management systems has never been easier. These open system modules provide a flexible and aesthetically pleasing way to easily connect communication cabling at the point-of-use.



Shown: Dual and Single Unloaded Keystone Jack Modules.

FEATURES & BENEFITS

- **Open system capabilities.** Unloaded modules are available to accept a wide range of industry standard keystone jacks, SC & ST fiber optic adapters, as well as, select proprietary solutions from AMP NET CONNECT, Avaya/Lucent and NORDX.
- **Wire management compatible.** Modules snap securely into Wiremold communication ready device brackets featuring 2A & 6A openings for an aesthetically pleasing look.
- **Installation and configuration ease.** Modules feature a front load snap-in design for ease of installation and allowing outlet configuration changes to be made quickly.
-  Listed.



Communication modules provide a seamless point-of-use interface in Wiremold wire and cable management systems. Shown: Vista Architectural Column, OFR Series Overfloor Raceway and Prewired Aluminum Raceway.

CM Series Open System Modules Ordering Information

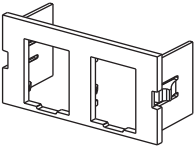
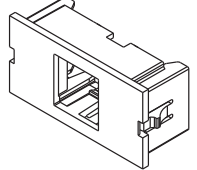
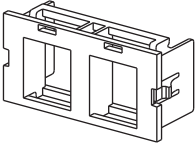
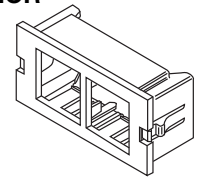
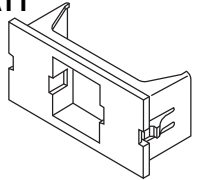
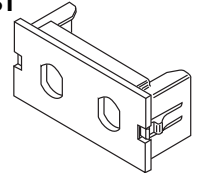
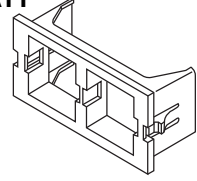
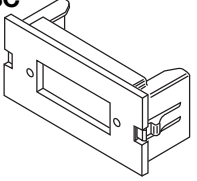
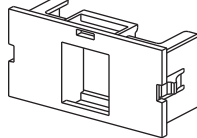
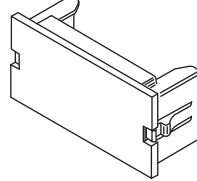
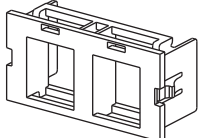
Catalog No./Item	Description/Specifications	Catalog No./Item	Description/Specifications
CM2-U2TJ 	2A, Dual Flushmount Unloaded Ortronics® TracJack® Module – For mounting two Ortronics® TracJack devices.	CM2-U1NOR 	2A, Single Flushmount NORDX/ CDT Unloaded Module – For use with MDVOFlex Jacks and Fiber Modules.
CM2-U2AMP 	2A, Single Unloaded AMP NETCONNECT Module – For mounting two AMP NETCONNECT SL Series devices.	CM2-U2NOR 	2A, Dual Flushmount NORDX/ CDT Unloaded Module – For use with MDVOFlex Jacks and Fiber Modules.
CM2-U1ATT 	2A, Single Unloaded Avaya/Lucent Module – For use with M-Series Jacks and LC Adapters.	CM2-U2ST 	2A, Dual Unloaded ST Adapter Module
CM2-U2ATT 	2A, Dual Unloaded Avaya/Lucent Module – For use with M-Series Jacks and LC Adapters.	CM2-U2SC 	2A, Unloaded Duplex SC Adapter Module
CM2-U1KEYA 	2A, Single Flushmount Unloaded Keystone Module – For mounting jacks with a latching area of 0.57" x 0.76" [14.5mm x 19.3mm].	CM2-BL 	Blank Insert
CM2-U2KEYA 	2A, Dual Flushmount Unloaded Keystone Module – For mounting jacks with a latching area of 0.57" x 0.76" [14.5mm x 19.3mm].		

NOTE: Standard color is Ivory, for other colors add suffix: "-WH" for White, "-GY" for Light Gray (matches aluminum and nonmetallic raceways), "-BK" for Black, and "-G" for Gray (matches Gray steel raceways).

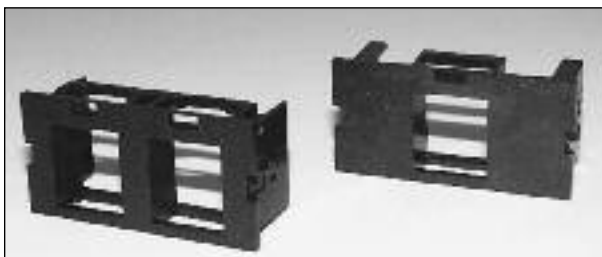

Shown: Dual and Single Unloaded Keystone Jack Modules.

6A Communication Opening

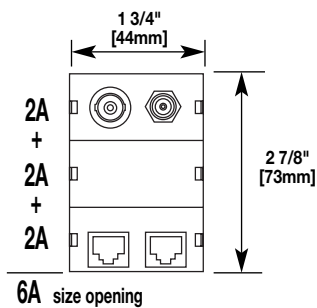

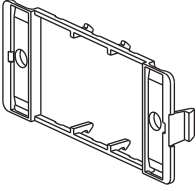
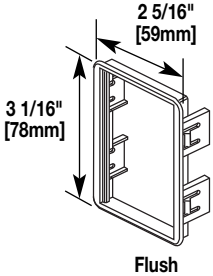
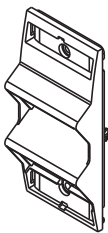

CM Series Communication Module Mounting Adapters Ordering Information

Catalog No./Item	Description/Specifications
<p>CM-EPLA*</p> 	<p>End Plates – Includes two outlet identification labels with clear covers and two matching screw covers. Required for mounting Pass & Seymour® Activate™ and Wiremold Open System communication modules into 4050, 5450, 5550, 2344SD-2A, 2344D-2A, WSX07-X, 40N2, 60N2, and CXN Series device brackets.</p>
<p>CM-MAB</p> 	<p>6A Mini Adapter 6A Opening – Must be purchased separately for mounting modules into Walker Systems where it is indicated they are not included. Available in Ivory.</p>
<p>CM-ARA*</p> 	<p>Angled Raceway Adapter – With two outlet identification labels with clear covers and two matching screw covers. Provides angled exit in multichannel raceway systems and WallSource™ Boxes. Accepts two 2A size modules. Snaps into standard device mounting brackets.</p>

* Standard color is Ivory, for other colors add suffix: “-WH” for White, or “-G” for Gray (matches Gray steel raceways).

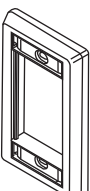
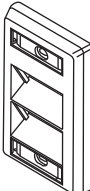
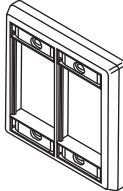
CM Series Faceplates Ordering Information

Catalog No./Item	Description/Specifications	Catalog No./Item	Description/Specification
<p>CM-SFP</p> 	<p>Single Gang Faceplate – For mounting three (3) CM2 Series modules or Pass & Seymour® Activate™ Series device modules.</p>	<p>CM-SAP</p> 	<p>Single Gang Angled Faceplate – For mounting three (3) CM2 Series modules or Pass & Seymour® Activate™ Series device modules.</p>
<p>CM-DFP</p> 	<p>Double Gang Faceplate – For mounting six (6) CM2 Series modules or Pass & Seymour® Activate™ Series device modules.</p>	<p>CM-DAP</p> 	<p>Double Gang Angled Faceplate – For mounting four (4) CM2 Series modules or Pass & Seymour® Activate™ Series device modules.</p>

NOTE: Add suffix “-WH” to indicate White finish.

Shown: Dual and Single Unloaded Keystone Jack Modules.



NOTES



Electrical Wiring Systems

60 Woodlawn Street
West Hartford, CT 06110
Phone: 1.877.BY.LEGRAND (295-3472)
www.legrand.us

570 Applewood Crescent
Vaughan, Ontario L4K 4B4
Phone: 905.738.9195
www.legrand.ca

ED1119R8 – Updated July 2013 – For latest specs visit www.legrand.us/wiremold

© Copyright 2013 Legrand All Rights Reserved

