

DESCRIPTION

The SkyRidge™ transforms ambient lighting by perfectly blending a refined modern styling with our breakthrough WaveStream™ LED technology to deliver exceptional performance and superior energy savings. SkyRidge's advanced engineered LED system with superior optical design delivers an unparalleled combination of optimal light uniformity and exceptional efficiency for greater energy savings.

SkyRidge is compatible with all of today's popular ceiling systems and available in a variety of configurations for application versatility. Its perfect balance of form and function make it an ideal choice for commercial office spaces, schools, hospitals, retail and other indoor ambient applications.

SPECIFICATION FEATURES

Construction

Shallow 4.75" deep housing is extruded aluminum frame and injected molded composite end plates. End plates are securely attached with screws for strength and rigidity and the elimination of gaps. End plates have accessory grid-lock feature for safety and convenience. Four auxiliary fixture end suspension points are provided. Large access plate for supply connection.

Controls

The SkyRidge LED is Powered by Fifth Light, with a standard 0-10V continuous dimming driver that works with any 0-10V control/dimmer. Combine with energy saving products like occupancy sensors, daylighting controls and lighting relay panels to maximize energy savings. In addition, the SkyRidge can include a factory-installed integrated sensor system for occupancy and daylight dimming control and manual control from an optional handheld remote. Or, specify the Digital Addressable Lighting Interface (DALI) drivers, dimmable down to 1% with the HD option, for use with Fifth Light controls. See ordering information for details on all three options.

Electrical

Long-life LED system coupled with electrical driver to deliver optimal performance. LED's available in 3000K, 3500K, 4000K or 5000K with a typical CRI ≥ 85. Projected life is 100,000 hours at 92% lumen output. Electronic drivers are available for 120-277V applications.

Emergency Battery Pack Option

Optional 120v-277v integral emergency battery pack is available in 7-watts or 14-watts to meet critical life-safety lighting requirements. The 90-minute batteries provide constant power to the LED system, ensuring code-compliance. A test switch/indicator button can be tested safely from the ground using a laser pointer, while the patented EZ Key prevents accidental discharge of the battery during construction. See ordering information for details.

Driver Access

Drivers can be accessed via plenum.

Finish

Durable frame has high reflectance baked matte white enamel finish for luminous uniformity.

Catalog #		Type
Project		
Comments		Date
Prepared by		

Optics

Precision formed optical assembly with positively retained high optical grade acrylic lens provides a directed optical distribution using WaveStream LED technology.

SkyTrim Accessory

Designed for an array of interior applications, SkyTrim is a luminous decorative accent that can be mounted directly on the light guide of a SkyRidge fixture either at the factory or in the field. It is ideal for spaces where color is necessary to provide visual cues, emphasize brand identity, directional awareness or simply as an artistic expression.

Compliance

Components are UL recognized. Indoor luminaires are cULus listed for 25° C ambient environments, RoHS compliant, and comply with IESNA LM-79. LEDs comply with LM-80 standards. DesignLights Consortium™ Qualified and classified for both DLC Standard and DLC Premium, refer to www.designlights.org for details.

Warranty

Five year warranty.



**22SR
LED**

**2' X 2' TROFFER
LED MODULE**

Specification Grade Troffer



CERTIFICATION DATA

cULus - 1598 and 2043**
 Damp Location Listed
 IC Rated
 LM79/LM80 Compliant
 ROHS Compliant
 DesignLights Consortium™ Qualified
 NOM Compliant

*See Drywall Frame Kit Accessory in Ordering Information section.

**Fixture construction is suitable for use in Air-handling and plenum rated spaces in accordance with Section 300.22 (C) of the National Electrical Code, Section 4.3.11.2.6.5 of NFPA 90A and Section 602.2.1.4 of ICC.

LINEAR DISCONNECT

Safe and convenient means of disconnecting power



PS519068EN
 2017-02-07 17:09:24

CURVED

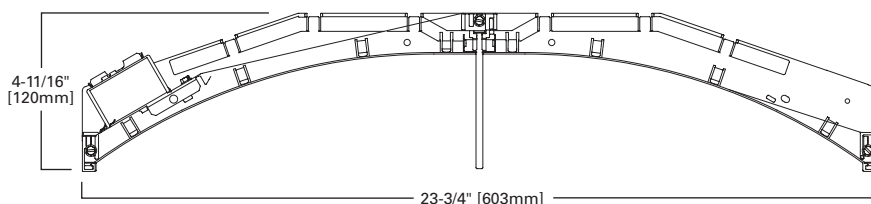

MOUNTING DATA

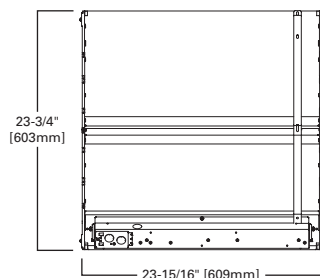

LAMP CONFIGURATIONS

CURVED

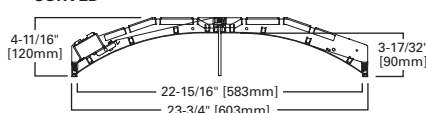

STRAIGHT

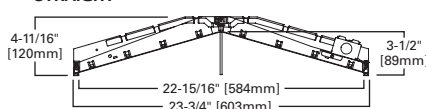

CEILING COMPATIBILITY

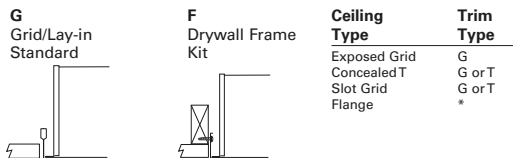

PHOTOMETRICS

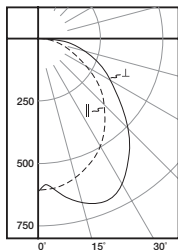

22SR-LD2-20-C-UNV-L835-CD1-U

Electronic Driver
Linear LED 3500K
Spacing criterion:
(||) 1.2 x mounting height, (⊥) 1.5 x mounting height
Lumens: 2007
Input Watts: 15.4W
Efficacy: 130.3 lm/W
Test Report:
22SR-LD2-20-C-UNV-L835-CD1-U.IES

Candlepower

Angle	Along	45°	Across ⊥
0	610	610	610
5	604	588	605
10	593	610	642
15	576	627	681
20	555	633	701
25	526	622	696
30	494	599	670
35	455	563	621
40	413	518	562
45	368	470	499
50	319	421	437
55	268	372	379
60	217	324	327
65	170	278	280
70	127	231	234
75	91	186	186
80	59	137	127
85	29	74	63
90	0	0	0

Coefficients of Utilization

rc rw RCR	Effective floor cavity reflectance																							
	80%				70%				50%				30%				10%				0%			
	70	50	30	10	70	50	30	10	50	30	10	50	30	10	50	30	10	50	30	10	50	30	10	
0	119	119	119	119	116	116	116	116	111	111	111	106	106	106	102	102	102	100	100	100	100	100	100	
1	108	103	98	94	105	100	96	92	96	92	89	92	89	87	88	86	84	82	82	82	82	82	82	
2	98	89	82	75	95	87	80	75	83	78	73	80	75	71	77	73	69	67	67	67	67	67	67	
3	89	78	69	62	86	76	68	62	73	66	61	70	64	59	68	63	58	56	56	56	56	56	56	
4	81	69	59	52	79	67	59	52	65	57	51	62	56	51	60	55	50	48	48	48	48	48	48	
5	74	61	52	45	72	60	51	45	58	50	44	56	49	44	54	48	43	41	41	41	41	41	41	
6	69	55	46	39	67	54	45	39	52	44	39	50	44	38	49	43	38	36	36	36	36	36	36	
7	64	50	41	34	62	49	40	34	47	40	34	46	39	34	45	38	34	32	32	32	32	32	32	
8	59	45	37	31	58	45	36	31	43	36	30	42	35	30	41	35	30	28	28	28	28	28	28	
9	55	42	33	28	54	41	33	27	40	32	27	39	32	27	38	32	27	25	25	25	25	25	25	
10	52	38	30	25	51	38	30	25	37	30	25	36	29	25	35	29	24	23	23	23	23	23	23	

Zonal Lumen Summary

Zone	Lumens	% Fixture
0-30	515	25.7
0-40	855	42.6
0-60	1512	75.3
0-90	2007	100.0
0-180	2007	100.0

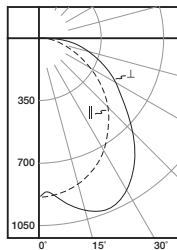

22SR-LD2-29-C-UNV-L835-CD1-U

Electronic Driver
Linear LED 3500K
Spacing criterion:
(||) 1.2 x mounting height, (⊥) 1.5 x mounting height
Lumens: 2948
Input Watts: 23.4W
Efficacy: 126.0 lm/W
Test Report:
22SR-LD2-29-C-UNV-L835-CD1-U.IES

Candlepower

Angle	Along	45°	Across ⊥
0	892	892	892
5	883	860	884
10	868	896	946
15	844	920	975
20	811	930	1030
25	768	915	1023
30	720	881	985
35	665	826	916
40	603	761	827
45	536	691	733
50	467	619	640
55	393	547	557
60	317	477	482
65	247	408	411
70	187	341	345
75	131	275	274
80	87	202	186
85	44	107	93
90	0	0	0

Coefficients of Utilization

rc rw RCR	Effective floor cavity reflectance																							
	80%				70%				50%				30%				10%				0%			
	70	50	30	10	70	50	30	10	50	30	10	50	30	10	50	30	10	50	30	10	50	30	10	
0	119	119	119	119	116	116	116	116	111	111	111	106	106	106	102	102	102	100	100	100	100	100	100	
1	108	103	98	94	105	100	96	92	96	92	89	92	89	87	88	86	84	82	82	82	82	82	82	
2	98	89	82	75	95	87	80	75	83	78	73	80	75	71	77	73	69	67	67	67	67	67	67	
3	89	78	69	62	86	76	68	62	73	66	61	70	64	59	68	63	58	56	56	56	56	56	56	
4	81	69	59	52	79	67	59	52	65	57	51	62	56	51	60	55	50	48	48	48	48	48	48	
5	74	61	52	45	72	60	51	45	58	50	44	56	49	44	54	48	43	41	41	41	41	41	41	
6	69	55	46	39	67	54	45	39	52	44	39	50	44	38	49	43	38	36	36	36	36	36	36	
7	64	50	41	34	62	49	40	34	47	40	34	46	39	34	45	38	34	32	32	32	32	32	32	
8	59	45	37	31	58	45	36	31	43	36	30	42	35	30	41	35	30	28	28	28	28	28	28	
9	55	42	33	28	54	41	33	27	40	32	27	39	32	27	38	32	27	25	25	25	25	25	25	
10	52	38	30	25	50	38	30	25	37	30	25	36	29	25	35	29	24	23	23	23	23	23	23	

Zonal Lumen Summary

Zone	Lumens	% Fixture
0-30	756	25.6
0-40	1256	42.6
0-60	2221	75.3
0-90	2948	100.0
0-180	2948	100.0

LUMEN MAINTENANCE

Ambient Temperature	TM-21 Lumen Maintenance (100,000 hours)	Theoretical L70 (Hours)
25°C	> 92%	> 448,000

Non-IC data

SKYTRIM FIELD INSTALLATION KITS

Color Choice	Kit Catalog Number	Kit Quantity
Tahitian Blue	STK-2-TB-10PK	10
Primary Green	STK-2-PG-10PK	10
Storaro Orange	STK-2-SO-10PK	10
Belladonna Rose	STK-2-BR-10PK	10
Medium Red	STK-2-MR-10PK	10
Pearl	STK-2-PL-10PK	10
Straw	STK-2-ST-10PK	10

Note: Chosen color will be matched on acrylic but will appear lighter once applied to lit light guide.

ENERGY AND PERFORMANCE DATA BY CATALOG NUMBER

Stock or MTO*	Catalog Logic (Curved)	Delivered Lumens	Watts	Efficacy (LPW)
MTO	22SR-LD2-20-C-UNV-L830-CD1-U	1947	15.4	126
Stock	22SR-LD2-20-C-UNV-L835-CD1-U	2007	15.4	130
Stock	22SR-LD2-20-C-UNV-L840-CD1-U	2047	15.4	133
MTO	22SR-LD2-20-C-UNV-L850-CD1-U	2228	15.4	145
MTO	22SR-LD2-25-C-UNV-L830-CD1-U	2449	19.6	125
MTO	22SR-LD2-25-C-UNV-L835-CD1-U	2525	19.6	129
MTO	22SR-LD2-25-C-UNV-L840-CD1-U	2576	19.6	131
MTO	22SR-LD2-25-C-UNV-L850-CD1-U	2803	19.6	143
MTO	22SR-LD2-29-C-UNV-L830-CD1-U	2860	23.4	122
Stock	22SR-LD2-29-C-UNV-L835-CD1-U	2948	23.4	126
Stock	22SR-LD2-29-C-UNV-L840-CD1-U	3007	23.4	129
MTO	22SR-LD2-29-C-UNV-L850-CD1-U	3272	23.4	140

Stock or MTO*	Catalog Logic (Straight)	Delivered Lumens	Watts	Efficacy (LPW)
MTO	22SR-LD2-20-S-UNV-L830-CD1-U	1982	15.4	129
MTO	22SR-LD2-20-S-UNV-L835-CD1-U	2043	15.4	133
MTO	22SR-LD2-20-S-UNV-L840-CD1-U	2084	15.4	135
MTO	22SR-LD2-20-S-UNV-L850-CD1-U	2268	15.4	147
MTO	22SR-LD2-25-S-UNV-L830-CD1-U	2494	19.6	127
MTO	22SR-LD2-25-S-UNV-L835-CD1-U	2571	19.6	131
MTO	22SR-LD2-25-S-UNV-L840-CD1-U	2622	19.6	134
MTO	22SR-LD2-25-S-UNV-L850-CD1-U	2853	19.6	146
MTO	22SR-LD2-29-S-UNV-L830-CD1-U	2911	23.4	125
MTO	22SR-LD2-29-S-UNV-L835-CD1-U	3001	23.4	128
MTO	22SR-LD2-29-S-UNV-L840-CD1-U	3061	23.4	131
MTO	22SR-LD2-29-S-UNV-L850-CD1-U	3331	23.4	143

*Made to order (MTO) requires a typical two week lead time.

ORDERING INFORMATION

SAMPLE NUMBER: 22SR-LD2-29-C-UNV-L835-CD1-SVPD1-U

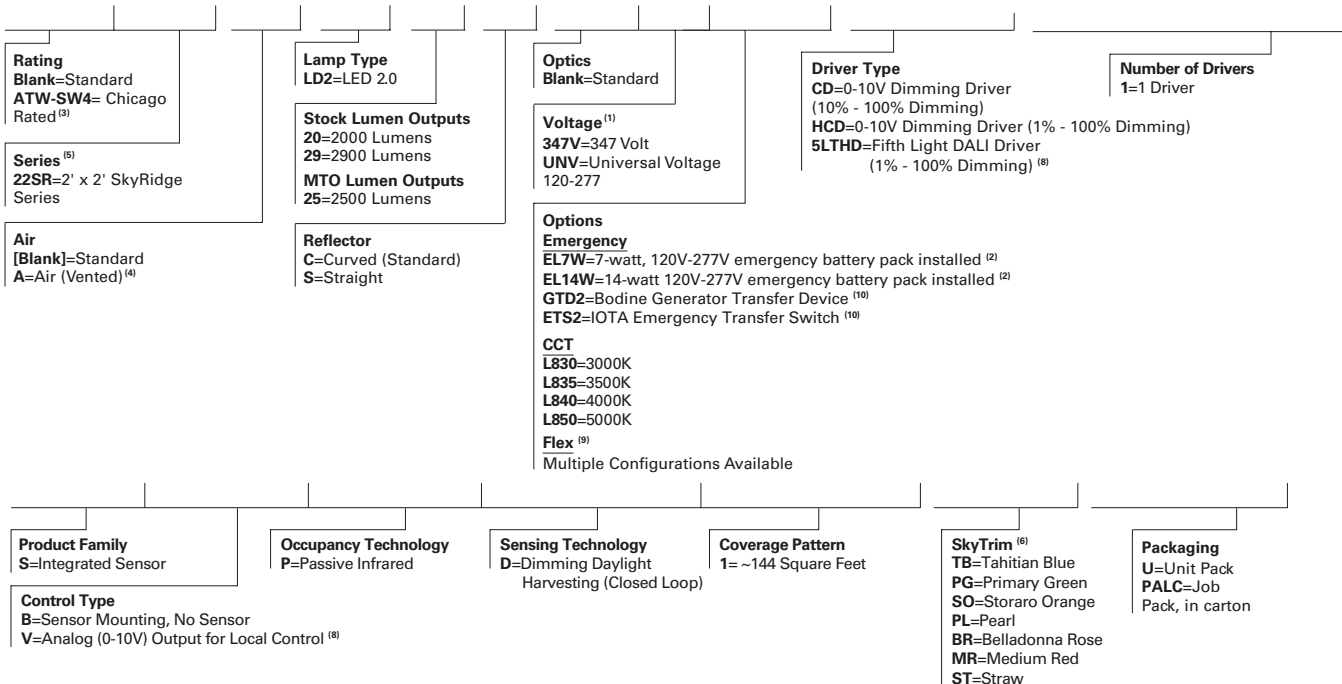

ACCESSORIES

- T3A END E.Q. BRACKET PARTS BAG (Standard with fixture)
- DF-22-W=2' x 2' Drywall Frame Kit
- SK-22-WT=2' x 2' Tall Surface Mount Kit
- DF10P-C=Decorator Dimmer, 0-10V
- SF10P-_=Decorator Slide Dimmer, 0-10V
- ISHH-01=Programming Remote for Integrated Sensor
- ISHH-02=Personal Control Remote for Integrated Sensor

NOTES: ⁽¹⁾Products also available in non-US voltages and frequencies for international markets. ⁽²⁾With integral test switch/indicator/laser test. For approximate delivered lumens multiply the lumens per watt of the desired fixture by the wattage of the emergency battery pack (100 lm/W x 7=700 lumens). IES-format photometry for luminaire under emergency operation available. ⁽³⁾Chicago rated version does not allow for row mounting. ⁽⁴⁾Air version is vented but does not meet air handling requirements. Air version is non-IC. Air version is not available with integrated sensor. ⁽⁵⁾DesignLights Consortium™ Qualified and classified for both DLC Standard and DLC Premium, refer to www.designlights.org for details. ⁽⁶⁾Fixtures using factory installed SkyTrim option are not DLC qualified. ⁽⁷⁾Must be used in conjunction with a DALI control system. For complete DALI solutions by Fifth Light, visit www.eaton.com/lightingsystems ⁽⁸⁾Integral sensor works only with "CD" driver and is factory prewired to the driver for stand-alone control. ⁽⁹⁾Flex does not include dimming leads. Control leads provided by others. ⁽¹⁰⁾Used to transfer fixture to secondary power source for life-safety operation. When used with a dimming fixture, two devices are required to ensure control is disabled while operating under emergency power.

Specifications & dimensions subject to change without notice. Consult your Eaton Representative for availability and ordering information.

SHIPPING DATA

Catalog No.	Wt.
22SR-LD2-20	12 lbs.
22SR-LD2-29	12 lbs.

INTEGRATED SENSOR

The SkyRidge with Integrated Sensor technology provides automatic energy savings without sacrificing performance. Traditionally, these types of energy savings required coordination between the luminaire and a lighting control system. The SkyRidge delivers superior lighting with integrated occupancy and daylighting controls.

Capture the benefits of traditional lighting controls, without complicated coverage planning or special wiring. Ideal for new construction or retrofit, the SkyRidge delivers automatic ON to an energy saving light level, while ensuring lighting is turned OFF when the space is unoccupied.

The integral daylight sensor reduces the need for special daylight zone planning. Each luminaire will automatically adjust the light level based on reflected light beneath the sensor in a closed loop method.

Occupied daylight light levels and unoccupied light levels can be adjusted using the integrated sensor programming remote (Catalog Number: ISHH-01). The integrated sensor personal remote (Catalog Number: ISHH-02) provides code compliant manual raise, lower, ON, OFF control.

The SkyRidge with Integrated Sensor is easy to install with no special wiring and ensures energy savings out-of-the-box with default control settings.

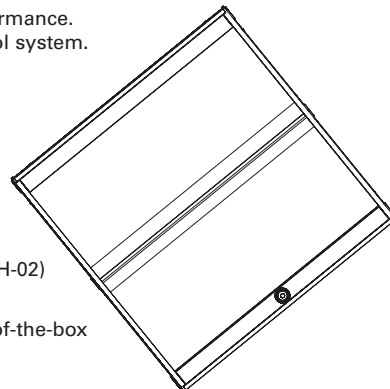

How it works:

- As the user enters the space controlled by the integral sensor, the lighting turns ON to the default daylight level.
- Lighting will remain at that the daylight level until the space is unoccupied. This will start the occupancy timeout period (default 20 minutes).
- If the space remains unoccupied for half of the timeout period, the lighting will automatically reduce to the Energy Saver light level. This adjustable light level is typically half of the occupied daylight level.
- At the end of the timeout period the lighting will go to the unoccupied light level. This adjustable light level uses the OFF default setting.

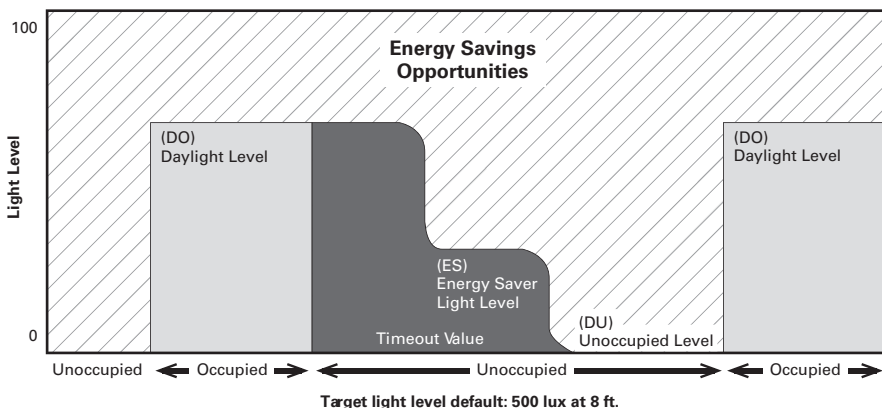

Coverage

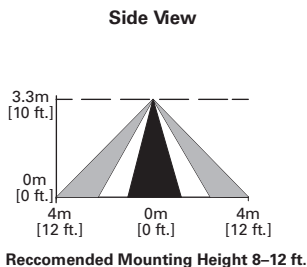
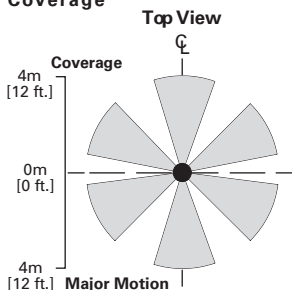

Optional Remote Controls

