

DESCRIPTION

The Halo PD6R Retrofit Kit is designed to be installed into other (Non-Halo Commercial) housings. Recessed 6-inch LED retrofit is available in various distributions, lumen and CRI/CCT options. Installs from below the ceiling into existing open frame recessed housings. Insulation must be kept 3" from top and sides of housing. Use for general area lighting where high efficiency and visual comfort are required.

SPECIFICATION FEATURES

MECHANICAL

Frame

Galvanized steel frame accommodates housing openings up to 7" diameter, 2" thick and installs with (2) remodel clips when installed from below the ceiling.

Junction Box

Provided with armored cables providing flexible connections to the LED module and existing junction box for mains voltage connections.

OPTICAL

LED Module

Proximity phosphors over chip on board LEDs provide a uniform source with high efficiency and no pixilation. Available in 80 or 90 CRI minimum, accuracy within 3 SDCM provides color uniformity. See ordering information for available CRI / CCT options. Passive thermal management achieves L70 at 50,000 hours in non IC applications. Integral diffuse lens provides visual shielding. Integral connector allows quick connection to housing flex.

Beam Forming Optics

Optional beam forming optics replace diffuse lens and provide narrow flood or flood distribution for long throws of light.

Reflector

Modular design accepts reflector, baffle, shallow baffle, wall wash and directional trims. Attaches to LED module with (3) speed clamps minimizing light leaks to lens. Requires TRM690WH oversized trim ring to cover existing cutout, provided with PD6R*.

Trim Retention

Reflectors are retained with two torsion springs holding the flange tightly to the finished ceiling surface.

ELECTRICAL

Driver

Integral UNV 120 - 277V 50/60 Hz constant current driver provides noise free operation. For 347V input use Halo transformer H347 or H347200. Continuous, flicker-free dimming from 100% to 10% with leading or trailing edge phase cut at 120V or 0 -10V analog control.

Emergency Option

Provides 90 minutes of standby lighting meeting most life safety codes for egress lighting. Available with remote charge indicator and test switch.

Compliance

- cULus classified for wet location

Catalog #		Type
Project		
Comments		Date
Prepared by		



PD6R10
PD6R15
PD6R20
PD6R30

PDM6A

Halo ML56 Trims
692, 693, 694
695, 696

1000, 1500,
2000 & 3000
Lumen Series

LED
6-Inch Aperture
Retrofit System

THD: ≤ 20%
PF: ≥ 0.90
T Ambient -30 - +40°C
Sound Rating ≤ 22dba

Lumens	1000 Series	
Input Voltage	120V	277V
Input Current	.103 A	.058 A
Input Power	12.1 W	13.2 W
Efficiency	92 LPW	92 LPW
Inrush Current	0.37 A	0.77 A

Lumens	1500 Series	
Input Voltage	120V	277V
Input Current	.146 A	0.072 A
Input Power	17.1 W	17.9 W
Efficiency	87 LPW	87 LPW
Inrush Current	0.47 A	1.04 A

Lumens	2000 Series	
Input Voltage	120V	277V
Input Current	.175 A	0.086 A
Input Power	20.78 W	21.06 W
Efficiency	94 LPW	94 LPW
Inrush Current	0.54 A	1.21 A

Lumens	3000 Series	
Input Voltage	120V	277V
Input Current	.299 A	.145 A
Input Power	35.72 W	36.4 W
Efficiency	86 LPW	86 LPW
Inrush Current	0.85 A	2.0 A

ORDERING INFORMATION

SAMPLE NUMBER: PD6R10ED010REM-PDM6A827-692W

A complete luminaire consists of a housing, LED module and reflector, order separately.

Housing	Lumens	Driver	Options	LED Module	CRI/CCT
PD6R = 6" aperture LED downlight retrofit PD6RCP = 6" aperture LED downlight retrofit, CCEA listed for City of Chicago plenum requirements	10 = 1,000 lumens (nominal) 15 = 1,500 lumens (nominal) 20 = 2,000 lumens (nominal)	ED010 = 120-277V 50/60Hz, 0-10V and LE/TE phase cut dimming	REM =emergency operation with remote indicator and test switch (not available with PD6RCP housing), 60 Hz	PDM6A = Downlight LED module for PD6 housing, provides 1,000, 1,500, 2,000, or 3,000 lumens (nominal) depending on connected housing type	827 =80 CRI, 2700K CCT 927 =90 CRI, 2700K CCT 830 =80 CRI, 3000K CCT 930 =90 CRI, 3000K CCT 835 =80 CRI, 3500K CCT 935 =90 CRI, 3500K CCT 840 =80 CRI, 4000K CCT 940 =90 CRI, 4000K CCT
	30 = 3,000 lumens (nominal)	D010 = 120-277V 50/60Hz, 0-10V dimming (3,000 lumen only)			

Reflector	Finish Option	Accessories
692 =6" reflector	SC =Specular clear with white flange H =Semi specular clear with white flange W =White with white flange	BFR56NFL = Beam forming reflector kit, narrow flood distribution BFR56FL = Beam forming reflector kit, flood distribution BFR56MH = Media holder, accepts one 3.45" lens L345SF = 3.45" diameter soft focus lens WW695SC = 6" wall wash kick reflector, specular clear (use for double or corner wall wash or replacement) H347 = Step down transformer for 347V input, 75VA max H347200 = Step down transformer for 347V input, 200VA max PORLWTPD1 = LumaWatt Pro Wireless Sensor Kit (0-10V only)
693 =6" baffle	WB =White baffle with white flange BB =Black baffle with white flange SNB =Satin nickel baffle and flange TBZB =Tuscan bronze baffle and flange	
694 =6" regressed eyeball directional	WB =White eyeball, baffle and flange SNB =Satin nickel eyeball, baffle and flange TBZB =Tuscan bronze eyeball, baffle and flange	
695 =6" wall wash	WW =Specular reflector, repositionable specular kick reflector and white flange	
696 =6" shallow baffle	WB =White baffle with white flange	

UL Classified to Retrofit into other Housings:

PD6MA LED Light Engine is compatible with PD6R* Retrofit applications and designed to work with Halo ML56 LED trim series: 692x, 693x, 694x, 695x, and 696x.

Lithonia Comercial

- LF6x
- LP6x

Philips Lightolier Lightcaster

- 1102P1x
- 1102D1x
- 1102HFx

Lithonia-Gotham

- AFx 6" Series
- LGx 6" Series

For the latest listing of qualified housings, please refer to the latest Halo Commercial LED Specification sheet that can be located on Cooper Lighting website: www.cooperlighting.com – select Halo Commercial.

DIMENSIONS

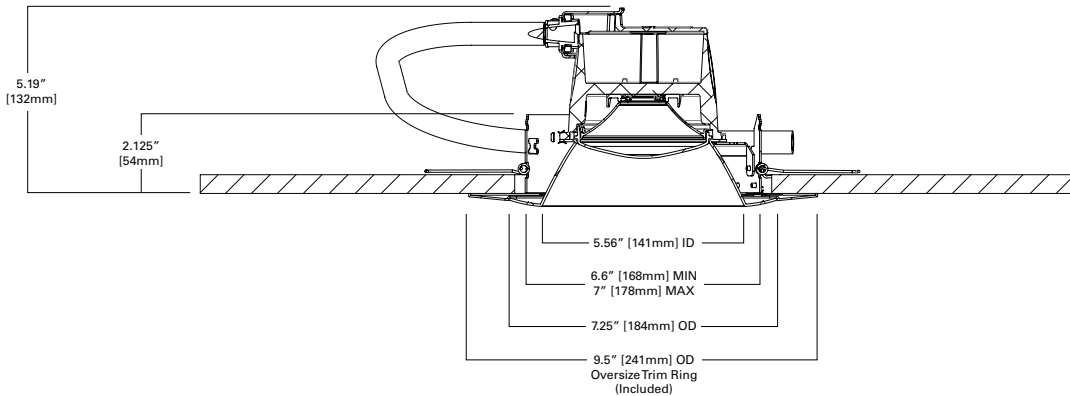

COMPLIANCE TABLE

1000 LUMEN

80 CRI																
Catalog #	PD6R10ED010- PDM6A827				PD6R10ED010- PDM6A830				PD6R10ED010- PDM6A835				PD6R10ED010- PDM6A840			
	LUMENS	LPW	ES	T24	LUMENS	LPW	ES	T24	LUMENS	LPW	ES	T24	LUMENS	LPW	ES	T24
692H	1060	798			1146	86			1212	90			1217	91		
692SC	1081	81			1169	87			1236	92			1241	93		
692W	1099	82			1188	89			1257	94			1262	94		
693WB	1087	81			1175	88			1243	93			1249	93		
693BB	809	60			875	65			926	69			930	69		
693SNB	924	69			999	75			1057	79			1061	79		
693TBZB	850	63			919	69			972	73			976	73		
696WB	1143	85			1236	92			1308	98			1313	98		
694WB	1168	87			1263	94			1336	100			1342	100		
694SNB	1134	85			1226	92			1297	97			1302	97		
694TBZB	1106	83			1196	89			1265	94			1270	95		
695WW	1078	80			1165	87			1233	92			1238	92		

90 CRI																
Catalog #	PD6R10ED010- PDM6A927				PD6R10ED010- PDM6A930				PD6R10ED010- PDM6A935				PD6R10ED010- PDM6A940			
	LUMENS	LPW	ES	T24	LUMENS	LPW	ES	T24	LUMENS	LPW	ES	T24	LUMENS	LPW	ES	T24
692H	810	61			874	65			937	70			1048	78		
692SC	826	62			891	67			956	71			1069	80		
692W	840	63			906	68			971	73			1087	81		
693WB	831	62			896	67			961	72			1075	80		
693BB	619	46			667	50			715	53			800	60		
693SNB	706	53			762	57			817	61			914	68		
693TBZB	650	49			701	52			751	56			840	63		
696WB	874	65			942	70			1011	75			1131	84		
694WB	893	67			963	72			1033	77			1155	86		
694SNB	867	65			935	70			1002	75			1121	84		
694TBZB	845	63			912	68			978	73			1094	82		
695WW	824	62			888	66			953	71			1066	80		

ES

ES = ENERGY STAR® Compliant

T24

T24 = Can be used to comply with California Title 24 Non-Residential

COMPLIANCE TABLE

1500 LUMEN

80 CRI																
Catalog #	PD6R15ED010- PDM6A827				PD6R15ED010- PDM6A830				PD6R15ED010- PDM6A835				PD6R15ED010- PDM6A840			
	LUMENS	LPW	ES	T24	LUMENS	LPW	ES	T24	LUMENS	LPW	ES	T24	LUMENS	LPW	ES	T24
692H	1403	76			1517	82			1604	87			1611	87		
692SC	1431	77			1547	84			1636	88			1643	89		
692W	1454	79			1572	85			1663	90			1671	90		
693WB	1439	78			1556	84			1646	89			1653	89		
693BB	1071	58			1158	63			1225	66			1230	67		
693SNB	1223	66			1322	71			1399	76			1405	76		
693TBZB	1125	61			1216	66			1287	70			1292	70		
696WB	1513	82			1636	88			1731	94			1738	94		
694WB	1546	84			1672	90			1769	96			1776	96		
694SNB	1501	81			1623	88			1717	93			1724	93		
694TBZB	1464	79			1582	86			1674	90			1681	91		
695WW	1426	77			1542	83			1631	88			1639	89		

90 CRI																
Catalog #	PD6R15ED010- PDM6A927				PD6R15ED010- PDM6A930				PD6R15ED010- PDM6A935				PD6R15ED010- PDM6A940			
	LUMENS	LPW	ES	T24	LUMENS	LPW	ES	T24	LUMENS	LPW	ES	T24	LUMENS	LPW	ES	T24
692H	1072	58			1156	63			1240	67			1387	75		
692SC	1094	59			1179	64			1265	68			1415	76		
692W	1112	60			1199	65			1286	70			1438	78		
693WB	1100	59			1186	64			1272	69			1423	77		
693BB	819	44			883	48			947	51			1059	57		
693SNB	935	51			1008	54			1081	58			1209	65		
693TBZB	860	46			927	50			995	54			1112	60		
696WB	1157	63			1247	67			1338	72			1497	81		
694WB	1182	64			1275	69			1367	74			1529	83		
694SNB	1147	62			1237	67			1327	72			1484	80		
694TBZB	1119	60			1207	65			1294	70			1447	78		
695WW	1091	59			1176	64			1261	68			1411	76		

ES

ES = ENERGY STAR® Compliant

T24

T24 = Can be used to comply with California Title 24 Non-Residential

COMPLIANCE TABLE

2000 LUMEN

80 CRI																
Catalog #	PD6R20ED010- PDM6A827				PD6R20ED010- PDM6A830				PD6R20ED010- PDM6A835				PD6R20ED010- PDM6A840			
	LUMENS	LPW	ES	T24	LUMENS	LPW	ES	T24	LUMENS	LPW	ES	T24	LUMENS	LPW	ES	T24
692H	1777	81			1922	87			2033	92			2042	93		
692SC	1813	82			1960	89			2074	94			2082	95		
692W	1843	84			1993	91			2108	96			2117	96		
693WB	1823	83			1971	90			2085	95			2095	95		
693BB	1357	62			1468	67			1553	71			1559	71		
693SNB	1550	70			1676	76			1773	81			1780	81		
693TBZB	1425	65			1541	70			1630	74			1637	74		
696WB	1918	87			2073	94			2193	100			2203	100		
694WB	1959	89			2119	96			2241	102			2251	102		
694SNB	1902	86			2056	93			2175	99			2185	99		
694TBZB	1855	84			2005	91			2121	96			2131	97		
695WW	1808	82			1954	89			2068	94			2076	94		

90 CRI																
Catalog #	PD6R20ED010- PDM6A927				PD6R20ED010- PDM6A930				PD6R20ED010- PDM6A935				PD6R20ED010- PDM6A940			
	LUMENS	LPW	ES	T24	LUMENS	LPW	ES	T24	LUMENS	LPW	ES	T24	LUMENS	LPW	ES	T24
692H	1359	62			1465	67			1572	71			1758	80		
692SC	1386	63			1494	68			1603	73			1793	81		
692W	1409	64			1519	69			1630	74			1823	83		
693WB	1394	63			1503	68			1612	73			1803	82		
693BB	1038	47			1119	51			1200	55			1342	61		
693SNB	1185	54			1278	58			1370	62			1533	70		
693TBZB	1090	50			1175	53			1260	57			1410	64		
696WB	1466	67			1581	72			1695	77			1897	86		
694WB	1498	68			1615	73			1733	79			1938	88		
694SNB	1454	66			1568	71			1682	76			1881	85		
694TBZB	1418	64			1529	69			1640	75			1834	83		
695WW	1382	63			1490	68			1598	73			1788	81		

ES

ES = ENERGY STAR® Compliant

T24

T24 = Can be used to comply with California Title 24 Non-Residential

COMPLIANCE TABLE

3000 LUMEN

80 CRI																
Catalog #	PD6R30D010- PDM6A827				PD6R30D010- PDM6A830				PD6R30D010- PDM6A835				PD6R30D010- PDM6A840			
	LUMENS	LPW	ES	T24	LUMENS	LPW	ES	T24	LUMENS	LPW	ES	T24	LUMENS	LPW	ES	T24
692H	2624	74			2837	79			3002	84			3014	84		
692SC	2676	75			2894	81			3061	86			3074	86		
692W	2721	76			2942	82			3112	87			3125	88		
693WB	2692	75			2910	82			3079	86			3092	87		
693BB	2004	56			2167	61			2292	64			2302	64		
693SNB	2288	64			2474	69			2617	73			2628	74		
693TBZB	2104	59			2275	64			2407	67			2417	68		
696WB	2831	79			3061	86			3238	91			3252	91		
694WB	2893	81			3128	88			3309	93			3323	93		
694SNB	2808	79			3036	85			3211	90			3225	90		
694TBZB	2738	77			2961	83			3132	88			3145	88		
695WW	2669	75			2885	81			3052	86			3066	86		

90 CRI																
Catalog #	PD6R30D010- PDM6A927				PD6R30D010- PDM6A930				PD6R30D010- PDM6A935				PD6R30D010- PDM6A940			
	LUMENS	LPW	ES	T24	LUMENS	LPW	ES	T24	LUMENS	LPW	ES	T24	LUMENS	LPW	ES	T24
692H	2006	56			2163	61			2320	65			2595	73		
692SC	2046	57			2206	62			2366	66			2647	74		
692W	2080	58			2243	63			2406	67			2691	75		
693WB	2058	58			2219	62			2380	67			2662	75		
693BB	1532	43			1652	46			1772	50			1982	56		
693SNB	1749	49			1886	53			2023	57			2263	63		
693TBZB	1609	45			1735	49			1861	52			2081	58		
696WB	2164	61			2334	65			2503	70			2800	78		
694WB	2212	62			2385	67			2558	72			2861	80		
694SNB	2147	60			2315	65			2483	70			2777	78		
694TBZB	2093	59			2257	63			2421	68			2708	76		
695WW	2040	57			2200	62			2360	66			2639	74		

ES

ES = ENERGY STAR® Compliant

T24

T24 = Can be used to comply with California Title 24 Non-Residential

PHOTOMETRY - 1000 lumen / 80 CRI

PD6R10ED010- PDM6A835-692SC

Spacing Criteria = 0.74

Lumens per Watt = 102.2 LpW

Test No. P138197

Test Model: PD6R10ED010- PDM6A835-692SC

Candlepower Distribution

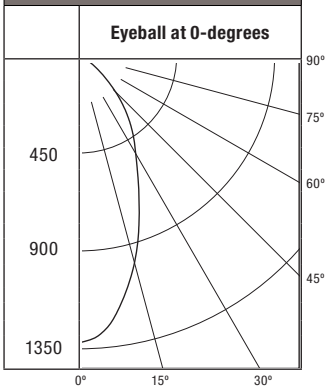

Candela Distribution	
Degrees Vertical	Candela
0*	1324
5	1277
10	1149
20	810
30	524
40	335
50	150
60	39
70	1
80	0
90	0

*CBCP

Luminance	
(Average Candela/M ²)	
Degree	Avg. 0° Luminance
45	18405
55	8019
65	1621
75	191
85	0

Cone of Light Footcandles			
Distance to Illuminated Plane	Initial Nadir Footcandles	Beam (ft.)	
		L Length	W Width
5.5	43.8	4	4
7	27	5	5
8	20.7	5.8	5.8
9	16.3	6.6	6.6
10	13.2	7.2	7.2
12	9.2	8.8	8.8

Beam diameter is to 50% of maximum footcandles, rounded to the nearest half-foot. Footcandle values are initial, apply appropriate light loss factors where necessary.

Zonal Lumen Summary		
Zone	Lumens	% Fixture
0-30	691	55.9
0-40	959	77.6
0-60	1220	98.7
0-90	1236	100

Scaling factor for the Battery back up:

- 1000 Lumen = 0.55
- 1500 Lumen = 0.40
- 2000 Lumen = 0.33
- 3000 Lumen = 0.22

PHOTOMETRY - 1000 lumen / 90 CRI

PD6R10ED010- PDM6A935-692SC

Spacing Criteria = 0.74

Lumens per Watt = 79 LpW

Test No. P138201

Test Model: PD6R10ED010- PDM6A935-692SC

Candlepower Distribution

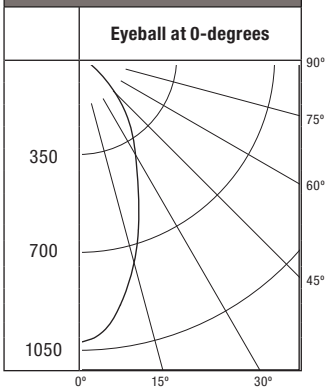

Candela Distribution	
Degrees Vertical	Candela
0*	1023
5	987
10	888
20	626
30	405
40	259
50	116
60	30
70	1
80	0
90	0

*CBCP

Luminance	
(Average Candela/M ²)	
Degree	Avg. 0° Luminance
45	14226
55	6203
65	1258
75	148
85	0

Cone of Light Footcandles			
Distance to Illuminated Plane	Initial Nadir Footcandles	Beam (ft.)	
		L Length	W Width
5.5	33.8	4	4
7	20.9	5	5
8	16	5.8	5.8
9	12.6	6.6	6.6
10	10.2	7.2	7.2
12	7.1	8.8	8.8

Beam diameter is to 50% of maximum footcandles, rounded to the nearest half-foot. Footcandle values are initial, apply appropriate light loss factors where necessary.

Zonal Lumen Summary		
Zone	Lumens	% Fixture
0-30	534	55.9
0-40	741	77.6
0-60	943	98.7
0-90	955	100

Scaling factor for the Battery back up:

- 1000 Lumen = 0.55
- 1500 Lumen = 0.40
- 2000 Lumen = 0.33
- 3000 Lumen = 0.22

PHOTOMETRY - 1500 lumen / 80 CRI

PD6R15ED010- PDM6A835-692SC

Spacing Criteria = 0.74
Lumens per Watt = 88.4 LpW
Test No. P167330
Test Model: PD6R15ED010- PDM6A835-692SC

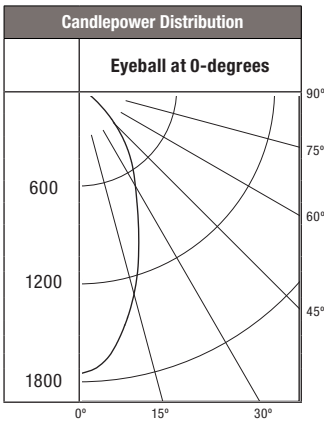

Candela Distribution	
Degrees Vertical	Candela
0*	1752
5	1691
10	1521
20	1072
30	694
40	443
50	198
60	52
70	1
80	0
90	0

*CBCP

Luminance	
(Average Candela/M ²)	
Degree	Avg. 0° Luminance
45	24367
55	10618
65	2140
75	254
85	0

Cone of Light Footcandles			
Distance to Illuminated Plane	Initial Nadir Footcandles	Beam (ft.)	
		L Length	W Width
5.5	57.9	4	4
7	35.8	5	5
8	27.4	5.8	5.8
9	21.6	6.6	6.6
10	17.5	7.2	7.2
12	12.2	8.8	8.8

Beam diameter is to 50% of maximum footcandles, rounded to the nearest half-foot. Footcandle values are initial, apply appropriate light loss factors where necessary.

Zonal Lumen Summary		
Zone	Lumens	% Fixture
0-30	915	55.9
0-40	1269	77.6
0-60	1615	98.7
0-90	1636	100

Scaling factor for the Battery back up:

- 1000 Lumen = 0.55
- 1500 Lumen = 0.40
- 2000 Lumen = 0.33
- 3000 Lumen = 0.22

PHOTOMETRY - 1500 lumen / 90 CRI

PD6R15ED010- PDM6A935-692SC

Spacing Criteria = 0.74
Lumens per Watt = 68.4 LpW
Test No. P167334
Test Model: PD6R15ED010- PDM6A935-692SC

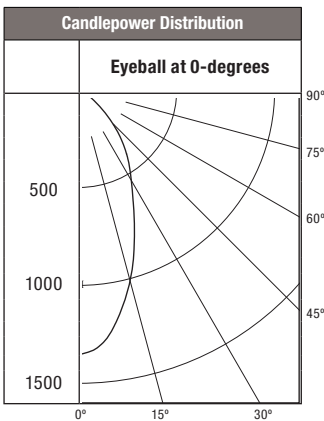

Candela Distribution	
Degrees Vertical	Candela
0*	1354
5	1307
10	1176
20	828
30	536
40	342
50	153
60	40
70	1
80	0
90	0

*CBCP

Luminance	
(Average Candela/M ²)	
Degree	Avg. 0° Luminance
45	18839
55	8210
65	1660
75	191
85	0

Cone of Light Footcandles			
Distance to Illuminated Plane	Initial Nadir Footcandles	Beam (ft.)	
		L Length	W Width
5.5	44.8	4	4
7	27.6	5	5
8	21.2	5.8	5.8
9	16.7	6.6	6.6
10	13.5	7.2	7.2
12	9.4	8.8	8.8

Beam diameter is to 50% of maximum footcandles, rounded to the nearest half-foot. Footcandle values are initial, apply appropriate light loss factors where necessary.

Zonal Lumen Summary		
Zone	Lumens	% Fixture
0-30	707	55.9
0-40	981	77.6
0-60	1248	98.7
0-90	1265	100

Scaling factor for the Battery back up:

- 1000 Lumen = 0.55
- 1500 Lumen = 0.40
- 2000 Lumen = 0.33
- 3000 Lumen = 0.22

PHOTOMETRY - 2000 lumen / 80 CRI

PD6R20ED010- PDM6A835-692SC

Spacing Criteria = 0.74
Lumens per Watt = 94.3 LpW
Test No. P138181
Test Model: PD6R20ED010- PDM6A835-692SC

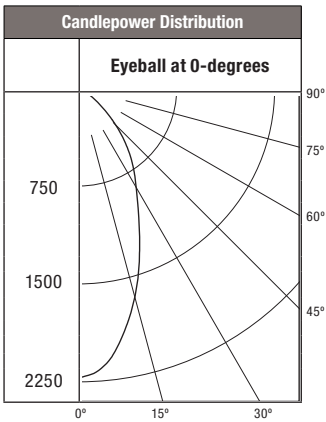

Candela Distribution	
Degrees Vertical	Candela
0*	2220
5	2143
10	1927
20	1358
30	879
40	562
50	252
60	66
70	2
80	0
90	0

*CBCP

Luminance	
(Average Candela/M ²)	
Degree	Avg. 0° Luminance
45	30879
55	13448
65	2724
75	318
85	0

Cone of Light Footcandles			
Distance to Illuminated Plane	Initial Nadir Footcandles	Beam (ft.)	
		L Length	W Width
5.5	73.4	4	4
7	45.3	5	5
8	34.7	5.8	5.8
9	27.4	6.6	6.6
10	22.2	7.2	7.2
12	15.4	8.8	8.8

Beam diameter is to 50% of maximum footcandles, rounded to the nearest half-foot.
Footcandle values are initial, apply appropriate light loss factors where necessary.

Zonal Lumen Summary		
Zone	Lumens	% Fixture
0-30	1160	55.9
0-40	1608	77.6
0-60	2047	98.7
0-90	2074	100

Scaling factor for the Battery back up:

- 1000 Lumen = 0.55
- 1500 Lumen = 0.40
- 2000 Lumen = 0.33
- 3000 Lumen = 0.22

PHOTOMETRY - 2000 lumen / 90 CRI

PD6R20ED010- PDM6A935-692SC

Spacing Criteria = 0.74
Lumens per Watt = 72.9 LpW
Test No. P138185
Test Model: PD6R20ED010- PDM6A935-692SC

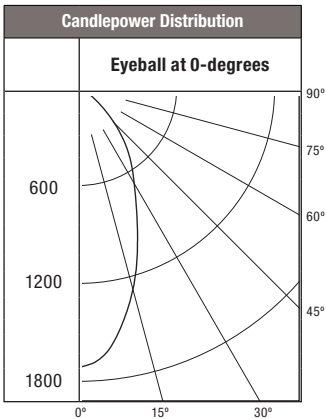

Candela Distribution	
Degrees Vertical	Candela
0*	1716
5	1656
10	1490
20	1050
30	679
40	434
50	194
60	51
70	1
80	0
90	0

*CBCP

Luminance	
(Average Candela/M ²)	
Degree	Avg. 0° Luminance
45	23871
55	10399
65	2101
75	254
85	0

Cone of Light Footcandles			
Distance to Illuminated Plane	Initial Nadir Footcandles	Beam (ft.)	
		L Length	W Width
5.5	56.7	4	4
7	35	5	5
8	26.8	5.8	5.8
9	21.2	6.6	6.6
10	17.2	7.2	7.2
12	11.9	8.8	8.8

Beam diameter is to 50% of maximum footcandles, rounded to the nearest half-foot.
Footcandle values are initial, apply appropriate light loss factors where necessary.

Zonal Lumen Summary		
Zone	Lumens	% Fixture
0-30	896	55.9
0-40	1243	77.6
0-60	1582	98.7
0-90	1603	100

Scaling factor for the Battery back up:

- 1000 Lumen = 0.55
- 1500 Lumen = 0.40
- 2000 Lumen = 0.33
- 3000 Lumen = 0.22

PHOTOMETRY - 3000 lumen / 80 CRI

PD6R30ED010- PDM6A835-692SC

Spacing Criteria = 0.74

Lumens per Watt = 85.7 LpW

Test No. P138213

Test Model: PD6R30ED010- PDM6A835-692SC

Candlepower Distribution

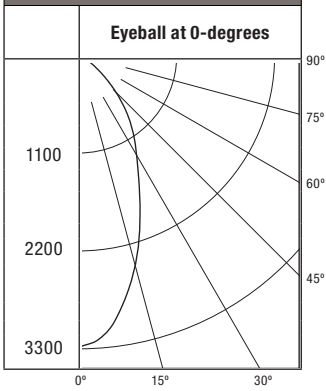

Scaling factor for the Battery back up:

- 1000 Lumen = 0.55
- 1500 Lumen = 0.40
- 2000 Lumen = 0.33
- 3000 Lumen = 0.22

Candela Distribution	
Degrees Vertical	Candela
0*	3278
5	3163
10	2845
20	2005
30	1298
40	829
50	371
60	97
70	2
80	0
90	0

*CBCP

Luminance	
(Average Candela/M ²)	
Degree	Avg. 0° Luminance
45	45586
55	19861
65	4008
75	466
85	0

Cone of Light Footcandles			
Distance to Illuminated Plane	Initial Nadir Footcandles	Beam (ft.)	
		L Length	W Width
5.5	108.4	4	4
7	66.9	5	5
8	51.2	5.8	5.8
9	40.5	6.6	6.6
10	32.8	7.2	7.2
12	22.8	8.8	8.8

Beam diameter is to 50% of maximum footcandles, rounded to the nearest half-foot. Footcandle values are initial, apply appropriate light loss factors where necessary.

Zonal Lumen Summary		
Zone	Lumens	% Fixture
0-30	1712	55.9
0-40	2374	77.6
0-60	3022	98.7
0-90	3061	100

PHOTOMETRY - 3000 lumen / 90 CRI

PD6R30ED010- PDM6A935-692SC

Spacing Criteria = 0.74

Lumens per Watt = 66.3 LpW

Test No. P138217

Test Model: PD6R30ED010- PDM6A935-692SC

Candlepower Distribution

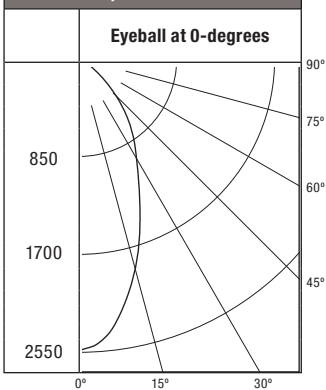

Scaling factor for the Battery back up:

- 1000 Lumen = 0.55
- 1500 Lumen = 0.40
- 2000 Lumen = 0.33
- 3000 Lumen = 0.22

Candela Distribution	
Degrees Vertical	Candela
0*	2534
5	2445
10	2199
20	1550
30	1003
40	641
50	287
60	75
70	2
80	0
90	0

*CBCP

Luminance	
(Average Candela/M ²)	
Degree	Avg. 0° Luminance
45	35236
55	15350
65	3100
75	360
85	0

Cone of Light Footcandles			
Distance to Illuminated Plane	Initial Nadir Footcandles	Beam (ft.)	
		L Length	W Width
5.5	83.8	4	4
7	51.7	5	5
8	39.6	5.8	5.8
9	31.3	6.6	6.6
10	25.3	7.2	7.2
12	17.6	8.8	8.8

Beam diameter is to 50% of maximum footcandles, rounded to the nearest half-foot. Footcandle values are initial, apply appropriate light loss factors where necessary.

Zonal Lumen Summary		
Zone	Lumens	% Fixture
0-30	1323	55.9
0-40	1835	77.6
0-60	2336	98.7
0-90	2366	100