

## DESCRIPTION

Gimbal Ring style lampholder designed for simplicity of form and minimal presence accommodates up to 75W Low Voltage MR16 lamps. Compatible with Halo and Lazer-by-Halo track systems (not for use with 4-Circuit track)

Catalog #	Type
Project	
Comments	
Prepared by	Date

## SPECIFICATION FEATURES

### A...Electrical Quick Lock Adapter / Transformer

Polycarbonate casing. Attaches electrically and mechanically along track. Contains integral 12V electronic transformer. Visual polarity line assures proper electrical connections. Two position conductor allows use in single circuit and either circuit of two-circuit track.

### B...Yoke

Yoke allows lampholder to rotate 338° horizontally° and adjust vertically from 0° to 90° for maximum aiming adjustability.

### C...Gimbal Ring

Die formed gimbal ring contains lamp retention clip.

Gimbal ring will accept a single glass lens or filter. Cover glass (required) is supplied with the fixture.

### Listings

UL listed and CSA Certified for use with Halo and Lazer-by-Halo track and Halo track systems.



## L2717

75W 12V  
MR16

LOW VOLTAGE  
GIMBAL RING  
LAMPHOLDER

POWER-TRAC

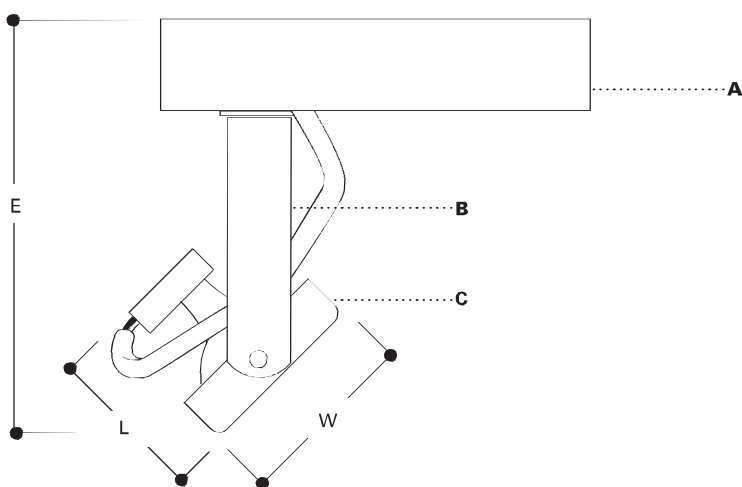

## ORDERING INFORMATION

SAMPLE NUMBER: L2717P

### Lampholders

L2717

### Finishes

P=Satin White  
MB=Black

### Accessories

L1960=Barn Doors  
L100=Series Color Filters/ Lenses  
L200=Baffle  
L1955=Concentrator

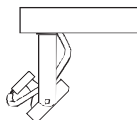

### L2717

NOT FOR USE WITH 4-CIRCUIT TRACK

For use with: 75W 12V MR16

L =2" [51mm]

W=2 1/8" [54mm]

E=4 7/8" [124mm]

### Accessories

L1960 Barn Doors

L100 Series Color

Filters/ Lenses

L200 Baffle

L1955 Concentrator

ADV990394

ACCESSORIES

**L100 Series Optical Lenses**

**L110N=Diffuse Sandblasted Lens**

Provides an even beam spread from MR16 lamps - especially useful in wall washing

**L111=Soft Focus Lens**

Smooths irregular beam pattern while maintaining high controlled illumination levels and beam angles of MR16 lamps

**L113=Prismatic Spread Lens**

Provides a symmetrical broadening of MR16 lamp beams. Suitable when a wide, uniform light distribution is required.

**L115=Linear Spread Lens**

Fans out the MR16 beam 55° (27 1/2° to each side) to produce a wide rectangular pattern

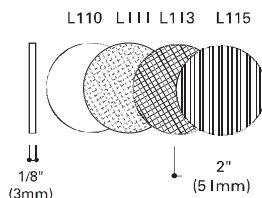

**L100 SERIES LENSES**

**2" UV AND COLOR FILTERS**

For use with MR 16 Lampholders. Provides either a soft or intense hue to accent a lighting installation. Replaces the glass shield provided with the lampholder

**L112=Red Gel Filter**

**L124=Daylight Blue, Dichroic Filter**

**L114=Ultraviolet, Dichroic Filter**

**L125=Blue, Dichroic Filter**

**L120=Red, Dichroic Filter**

**L127=Cosmetic (2700°K) Dichroic Filter**

**L121=Amber, Dichroic Filter**

**L130=Yellow Gel Filter**

**L122=Yellow, Dichroic Filter**

**L131=Amber Gel Filter**

**L123=Green, Dichroic Filter**

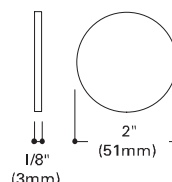

**L100 COLOR FILTERS**

**Barn Door Shutters**

**L1960=** Barn door is designed to clip onto lampholder- no additional clips are required.

Color Code: MB

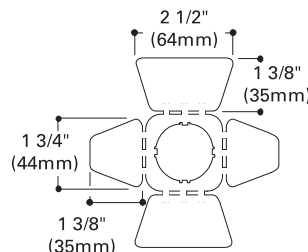

**BARN DOOR SHUTTERS**

**Accessory Baffle**

**L200=**Reduces glare and spill light

Color Code: MB

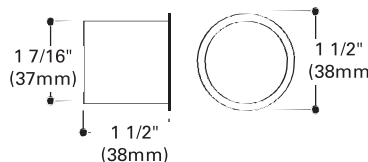

**BAFFLE**

**Beam concentrator**

**L1955=**Concentrates beam of MR16FL lamp to produce a well defined round spot of light.

Comes with three auxiliary round beam templates for choice of beam angle size

Color Code: MB

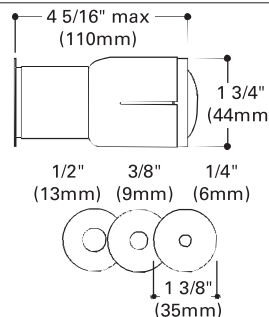

**BEAM CONCENTRATOR**

Note: Specifications and Dimensions subject to change without notice.

Visit our website at [www.cooperlighting.com](http://www.cooperlighting.com)