



Battery Operated Combination Carbon Monoxide & Smoke Alarm

Part Number 900-0102

Model KN-COSM-B

Voice Alarm

Announces the hazard type detected.

Test/Reset Button

Tests alarm circuitry and triggers the voice announcement.

Combined Carbon Monoxide and Smoke Alarm

A single unit can be installed where previously, two were needed. Reduces installation time and helps to keep home décor attractive.

LEDs

Two LEDs are provided. Flashing green for normal operation and flashing red for alarm condition.

Hush® Feature

Temporarily silences nuisance alarms.

Alerts user to replace CO alarm after 7 years of operation

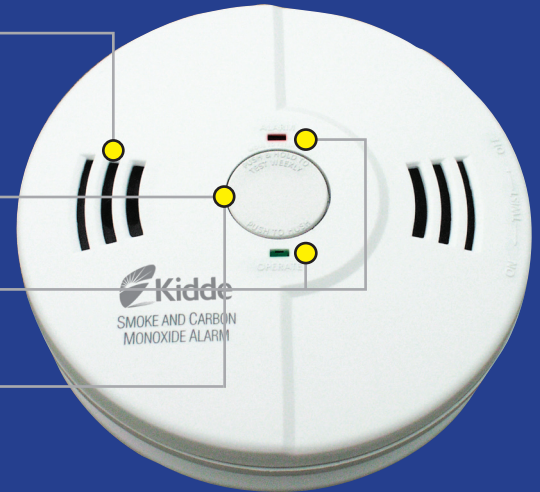

Description

The Kidde 900-0102 Combination Carbon Monoxide & Smoke Alarm provides two important safety devices in a single unit. This alarm includes a voice warning system that announces "Fire, Carbon Monoxide, Low Battery and Smart Hush™ Activation". The voice alarm eliminates any confusion and clearly warns you and your family of a smoke or carbon monoxide danger, or if your battery is in need of replacement. This technically advanced combination alarm is battery operated protecting you and your family even during a power outage when many incidences occur. The 900-0102 is an easy to install alarm that is suitable for all living areas and has a 7-year life and a 5-year limited warranty.

Alarm Warnings

Fire: The red LED will flash and be accompanied by three long alarm beeps followed by a verbal warning message "FIRE! FIRE!". The alarm will repeat pattern until smoke is eliminated.

Carbon Monoxide: Four short alarm beeps followed by a verbal warning "WARNING! CARBON MONOXIDE!" This continues until the unit is reset or the CO is eliminated.

Low Battery: One chirp followed by warning "LOW BATTERY". The red LED light will flash. This pattern will continue every minute for the first hour. After the first hour the red LED light will flash once every minute accompanied by the chirp sound. The "LOW BATTERY" warning will only sound once every fifteen minutes.

Voice Hush Indication: "HUSH ACTIVATED" and "HUSH CANCELLED" voice announcement.

Peak Level Memory: If the alarm had detected a CO level of 100ppm or higher, the unit will announce "CO PREVIOUSLY DETECTED" to warn of the CO incident, when the Test/Reset button is pressed.

Features and Benefits

- **Voice Alarm** – Announces the hazard type detected thereby helping to speed up the correct reaction to the hazard detected. Alarm announces "Fire Fire" when a smoke or fire hazard is detected and announces "Warning Carbon Monoxide" when a CO hazard is detected.
- **Combined Carbon Monoxide and Smoke Alarm** – A single unit can be installed where previously, two were needed. Reduces installation time and helps to keep home décor attractive.
- **Test/Reset Button** – Tests alarm circuitry and triggers the voice announcement.
- **LEDs** – Two LEDs are provided. Flashing green for normal operation and flashing red for alarm condition.
- **Low Battery Warning** – The unit warns of a low battery condition by announcing "low battery" and by initiating an alarm chirp and activating a flashing red LED.
- **Battery Powered** – Provides protection even during power outages when many fire and carbon monoxide incidents occur.
- **Battery Safeguard** – Ensures the unit cannot be accidentally mounted without batteries installed.
- **Hush® Feature** – Temporarily silences nuisance alarms.



Architectural and Engineering Specifications

The combination smoke and carbon monoxide alarm shall be Kidde Model Number KN-COSM-B (part number 900-0102) or approved equal. It shall be powered by 3 AA batteries. The unit shall incorporate an ionization smoke sensor with nominal sensitivity of 0.97 %/ft. The CO sensor shall be of a fuel cell design and provide accuracy of +/-20% + 15ppm. The temperature operating range shall be between 40°F and 100°F (4°C and 38°C) and the humidity operating range shall be 5% - 95% related humidity.

The combination alarm can be installed on the surface of any wall or ceiling following the UL/NFPA/Manufacturer's recommended placement guidelines. The alarm shall provide optional tamper resistance that deters removal of the unit from the wall or ceiling.

The alarm shall include a test button that will electronically simulate the presence of smoke and CO and cause the unit to go into both modes of alarm. This sequence tests the unit's electronics to ensure proper operation.

The CO sensor will not alarm to levels of CO below 30 ppm and will alarm in the following time range when exposed to the corresponding levels of CO.

70 ppm CO Concentration	60 – 240 minutes
150 ppm CO Concentration	10 – 50 minutes
400 ppm CO Concentration	4 – 15 minutes

The combination alarm shall have two methods of warning for danger: a piezoelectric horn that is rated at 85 decibels at 10 feet and a voice warning that identifies the danger. For a CO incident, the horn will sound in the repetitive manner -- four (4) fast beeps, a short pause, four (4) fast beeps, a short pause. In between, the unit will announce "Warning Carbon Monoxide!". In a Smoke incident, the horn will sound in the repetitive manner -- three (3) beeps, a pause, three (3) beeps, a pause. In between, the unit will announce "Fire! Fire!".

The unit shall also indicate a low battery warning utilizing each of the following methods: a brief alarm chirp, the voice announcement of "Low Battery!" and the red LED will flash once per minute. The unit shall incorporate 2 LED's. A green LED will flash when power is present. A red LED will flash once every 30-40 seconds to indicate the alarm is operating properly and will flash once per second when the unit is alarming and will remain so until the air is cleared.

The unit shall at a minimum meet the requirements of UL 2034, UL217, NFPA72, (chapter 11 2002 edition) The State of California Fire Marshall, NFPA101 (One and two family dwellings) Federal Housing Authority (FHA), Housing and Urban Development (HUD). It shall also include a 5-year manufacturer's limited warranty.

Technical Specifications

Unit Number:	900-0102
Model:	KN-COSM-B
Power Source:	3 AA Battery
Sensors:	Smoke: Ionization, CO: Electrochemical
Audio Alarm:	85dB at 10ft
Temperature Range:	40°F (4.4°C) to 100°F (37.8°C)
Humidity Range:	5%-95% relative humidity
Size:	5.75" in diameter x 1.7" depth
Weight:	13oz
Interconnects:	No

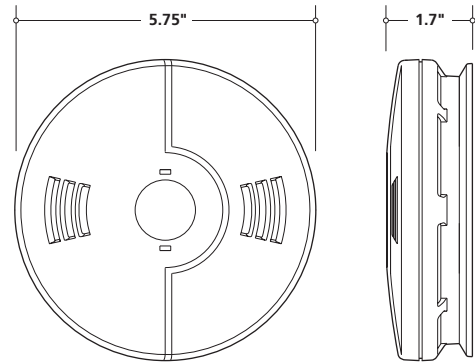

Ordering Information

UPC: 7 84908 01020 9

Part Number	I 2 of 5	Pack Quantity	Dimensions (w x d x h inches)	Weight	Case/Skid	Layers/Skid	Skid Weight
900-0102-02	107-84908-01020-6	PDQ (3 units)	8.0 x 11.25 x 6.25	2.5lbs	150	3	375lbs
900-0102-16	207-84908-01020-3	Cut Case (20 units)	16 x 12 x 21.8	18lbs	18	3	325lbs
900-0102-37	307-84908-01020-0	Power Tower (60 units)	20 x 24 x 41 (incl. pallet)	50lbs	3	3	150lbs
21005296	047-87105-2967	Bulk Pack (6 units)	12.5 x 6.25 x 7	5lbs	105	3	525lbs



1016 Corporate Park Drive
Mebane NC 27302
1-800-880-6788 www.Kidde.com

Distributed by: