

Conventional and Addressable Accessories

Door Holders

1500 Series



The Edwards 1500 Series electromagnetic door holders feature housings finished with durable baked polyester powder paint. The floor or wall section houses the electromagnet while the contact plate attaches to the door. The contact plate has a shock absorbing nylon (swivel) ball that allows the plate to adjust to any door angle. Floor units are available in single-door or double-door (back to back) versions. Wall units are available in flush or surface mounted versions. If power fails, doors are released automatically but may be opened or closed manually at any time. All units are free of moving parts, are self-contained and require no maintenance.

The device holders hold a door open while energized. When de-energized by a relay controlled by the fire alarm system or other switch, the door is released to a closed position.

Features and Specifications

- Floor and wall mounted styles
- Baked polyester powder paint finish
- Low power consumption
- Silent operation
- 25 Lbf (111N) nominal holding force
- Adjustable, swivel contact plate
- Single-door or double-door (back to back) versions – floor mounted
- Flush or surface mounted versions – wall mounted
- Operating temperature range: 32°F to 120°F (0°C to 49°C)

Ordering Information

Description	Cat. No.	Operating Voltage ¹	Current
Floor Mounted (Single Door)	1501-AQN5	24V AC; 24V DC/120V AC	0.015 A
Floor Mounted (Double Door)	1502-AQN5	24V AC; 24V DC/120V AC	0.015 A ²
Flush Wall Mounted (Long Catch Plate)	1504-AQN5	24V AC; 24V DC/120V AC	0.015 A
Flush Wall Mounted (Short Catch Plate)	1505-AQN5	24V AC; 24V DC/120V AC	0.015 A
Surface Wall Mounted	1508-AQN5	24V AC; 24V DC/120V AC	0.015 A
Completely Flush Wall Mounted	1509-AQN5	24V AC; 24V DC/120V AC	0.015 A

¹AC voltage frequency is 60 Hz

²Draws 0.015 A per side

Accessories

Description	Cat. No.
Catch plate extension assembly, 1.5"	1500-1
Catch plate extension assembly, 2.5"	1500-2
Catch plate extension assembly (5.25 to 7.5 inches)	1500-7
Catch plate extension assembly (7.5 to 12 inches)	1500-12
Replacement armature - short (for use with 1501, 1502, 1505, 1508 and 1509 door holders)	CS2595-5
Replacement armature - long (for use with 1504 door holder)	CS2598-5



MEA



Conventional and Addressable Accessories

Door Holders

1500 Series

Weights and Dimensions

Cat. No.	Approx. Shipping Weight (lb.)
1501-AQN5	5.40
1502-AQN5	5.00
1504-AQN5	2.00
1505-AQN5	2.00
1508-AQN5	3.00
1509-AQN5	2.00
1500-1	0.25
1500-2	0.25
1500-7	0.50
1500-12	1.00
CS2595-5	0.25
CS2598-5	0.25

Catch Plate Extensions

NOTE: Only the extension rods are included. The end pieces are included with the doorholders or can be ordered separately.

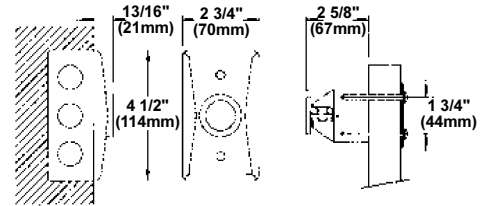
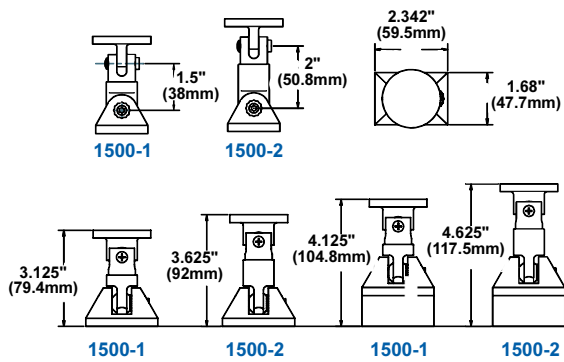
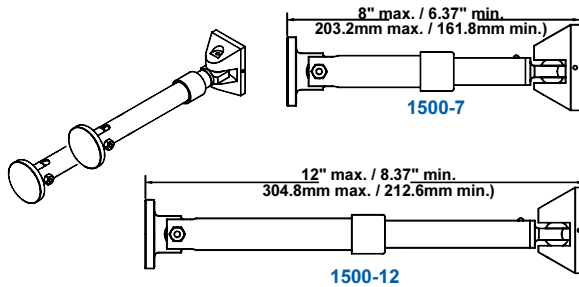

1504-AQN5 Flush Wall Mounted (Long Catch Plate)

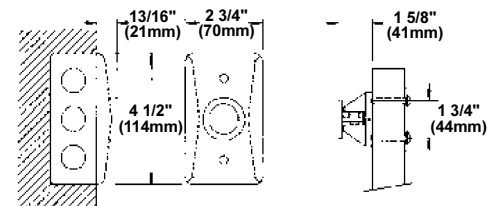

1505-AQN5 Flush Wall Mounted (Short Catch Plate)

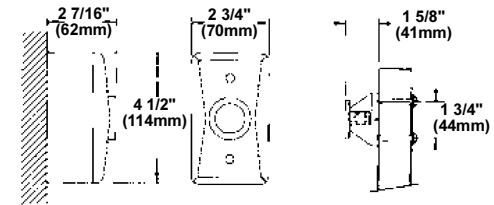

1508-AQN5 Surface Wall Mounted

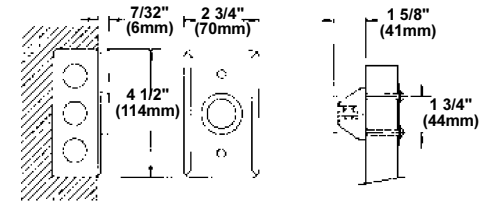

1509-AQN5 Completely Flush Wall Mounted

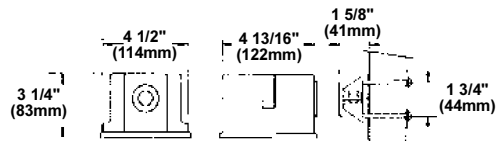

1501-AQN5 Floor Mounted (Single Door)

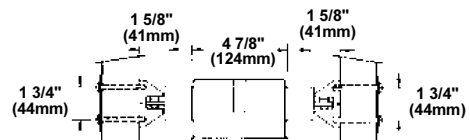

1502-AQN5 Floor Mounted (Double Door)