

PVC Coated ST Style Knockout Hub

Catalog Number: PRSTG4
UPC: 784011207510

Description

1-1/4 Inch STG Knockout Hub w/ Ground

PVC coated STG knockout hubs with grounding lug are used to terminate conduit runs through the wall of a sheet metal electrical enclosure.

Application

- Used to terminate conduit runs through the wall of a sheet metal electrical enclosure
- Used to terminate conduit runs through the wall of a sheet metal electrical enclosure

Features

- 40 mil gray PVC exterior coating
- 2 mil red urethane interior coating
- Available in 12 trade sizes from 1/2" through 6"
- Sealing sleeves on conduit side of hub
- Molded PVC gasket seals flush with enclosure wall
- O-ring gasket provides additional seal
- Furnished with a grounding lug

General

Material:	FERROUS METAL
Exterior Finish:	A nominal .040 inch (40 mil) gray PVC coating
Interior Finish:	A nominal .002 inch (2 mil) red urethane
Seal Type:	O-ring gasket
Grounding Lug:	Attached

Dimensions

Dimension A (Inches)	1.69
Dimension B (Inches)	3.25
Dimension C (Inches)	1.03
Max Wall Thickness (Inches)	.25
Nominal Weight (Pounds)	0.4

Technical / Specification Documents

Specification Guide (1995 Master)	AVAILABLE ON WEBSITE
Specification Guide (2004 Master)	AVAILABLE ON WEBSITE
Installer Certification and Tools	AVAILABLE ON WEBSITE
Chemical Resistance Charts	AVAILABLE ON WEBSITE
Performance Specifications	AVAILABLE ON WEBSITE

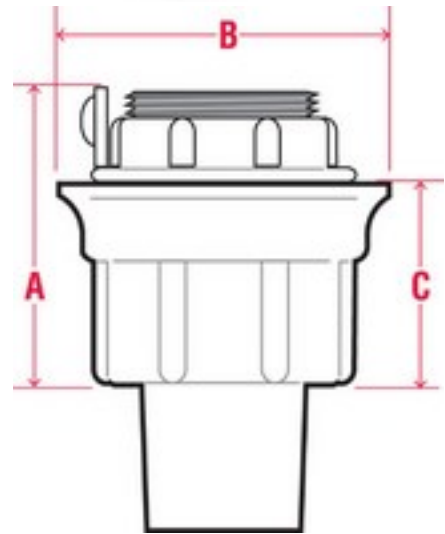



PVC Coated ST Style Knockout Hub

Catalog Number: PRSTG4
UPC: 784011207510

Standards

NEC/CEC:	Class I, Division 2
NEC/CEC:	Class II, Division 1 & 2
NEC/CEC:	Class III, Division 1 & 2

Notes

All Screw-tight Hubs are listed for NEMA and UL type enclosures 2, 3, 3R, 4, 4x, 11 and 12

Grounding and Bonding Hubs are listed for NEMA Enclosures 2, 3, 3R, 4 and

