

Low Pressure Sodium Lamps (SOX-E, SOX)

High energy efficiency low pressure sodium lamps
for indoor and outdoor applications



Ideal for roadway lighting, bridge and tunnel lighting, security lighting, area floodlighting, railway crossing lighting and airport lighting

▶ Excellent Energy Efficiency

Up to 180 lumens per watt

▶ Long Life

18,000 hours rated average life

▶ Vibration Resistant

Rough service arc tube support system provides protection against shock and vibration



PHILIPS

Candlepower Distribution Curves (cd/1000 lm—candelas per 1000 lumens)

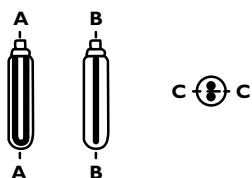
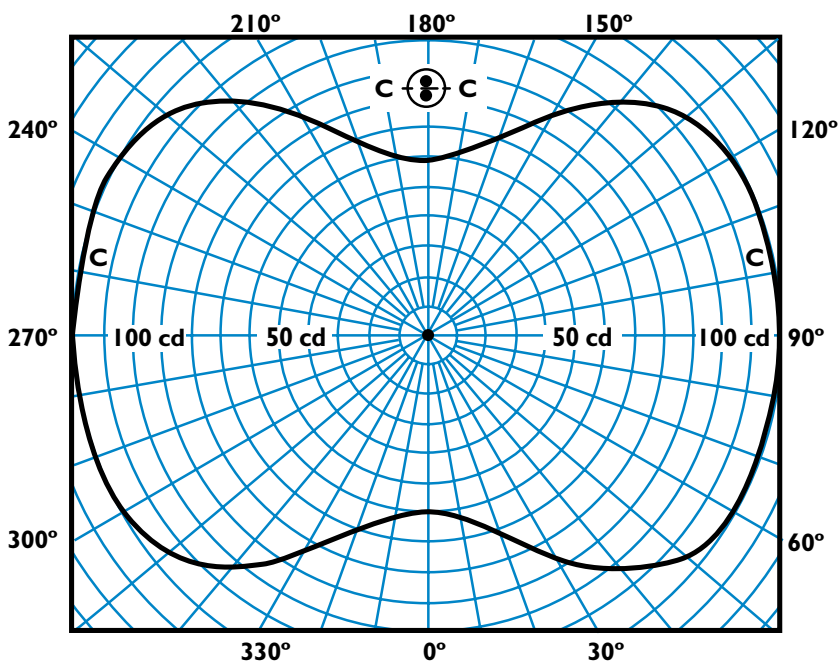
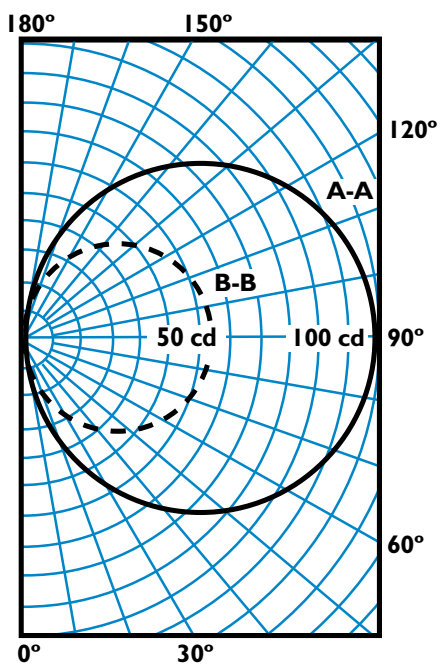

LOW PRESSURE SODIUM LAMPS (SOX-E AND SOX)

Warm-Up Characteristics

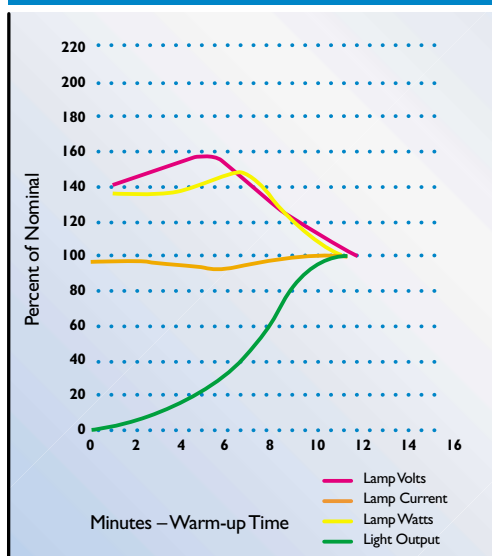

Effects of Input Voltage Variations

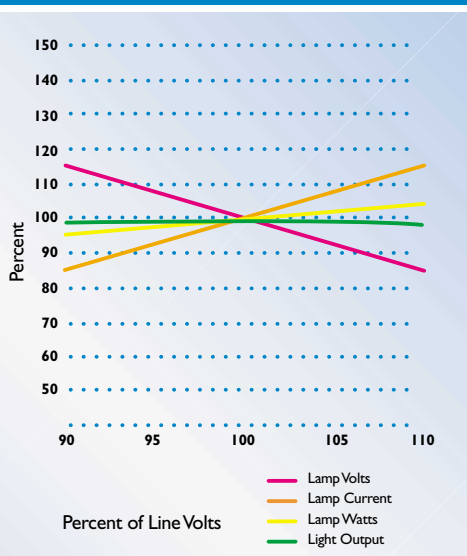

Low Pressure Sodium Lamp Construction

Physical Dimensions—SOX-E and SOX Lamps

Ordering Code	Bulb	MOL ¹ (A)		Max. Diameter (B)		LCL ² (C)		Light Length (D)	
		In.	mm	In.	mm	In.	mm	In.	mm
SOX-E 18	T-17	8 ½	216	2 ⅞	54	5 ½	141	3 ⅝	92
SOX 35	T-17	12 ¾	310	2 ⅞	54	7 ¼	184	7 ½	192
SOX 55	T-17	16 ¾	425	2 ⅞	54	9 ½	243	12	305
SOX 90	T-21	20 ¾	528	2 11⁄16	68	11 ½	292	5 ⅞	403
SOX 135	T-21	30 ½	775	2 11⁄16	68	16 ⅞	416	25 ⅞	646
SOX 180	T-21	44 ⅞	1120	2 11⁄16	68	23	584	38	965

1. MOL = Maximum Overall Length

2. LCL = Light Center Length

Base: Double Contact Bayonet-Medium (BY-22d)

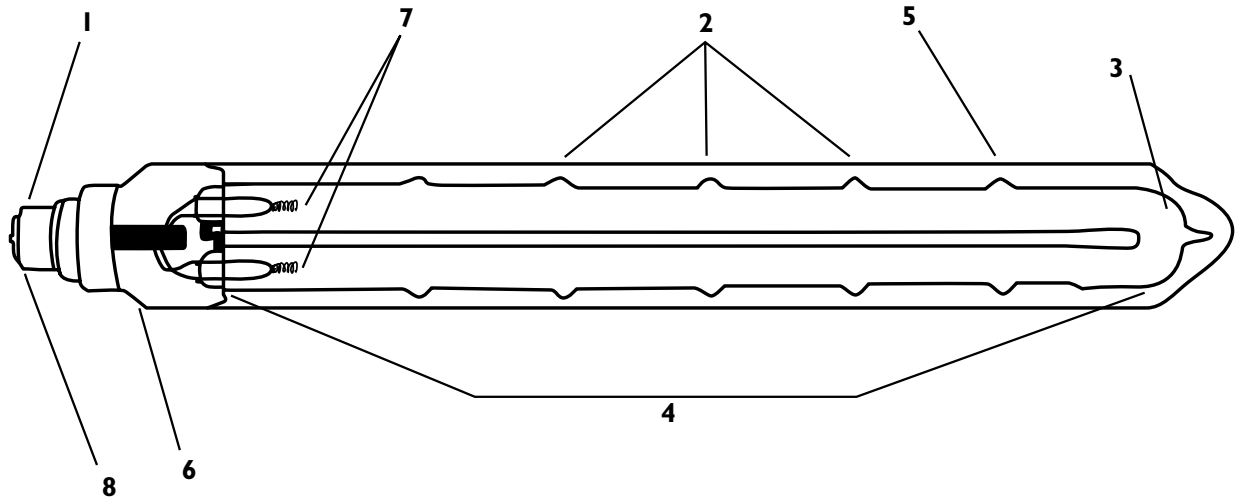
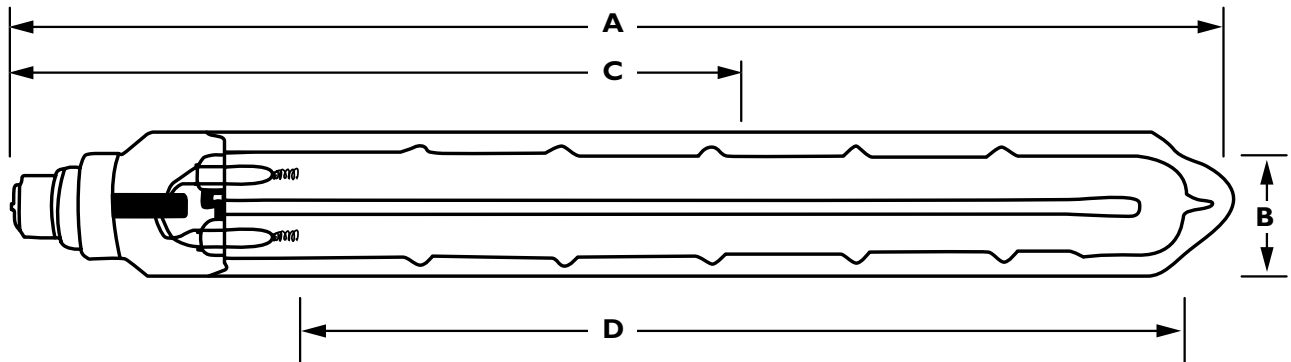

1. Non-Metallic-Bayonet Base will not corrode or stick in lamp socket, providing quick, safe relamping. Locking pins on lamp base assure the lamp locks in socket and cannot vibrate loose. SOX-E lamps are distinguished by the use of the black bases compared to the tan bases used on SOX lamps.

2. Sodium Retaining Reservoirs provide even distribution of sodium for 100% lumen maintenance, long lamp life and lamp wattage control.

3. U-Bend Insulation Feature controls lamp wattage rise and helps provide more consistent lamp life.

4. Rough Service Arc Tube Support System eliminates arc tube movement along lamp axis yet allows radial arc tube flex. It provides highest protection from shock and vibration.

5. Uniform Indium Oxide Heat Reflecting Coating creates highest luminous efficacy of all light sources and contributes to 100% lumen maintenance by keeping arc tube at the optimum temperature.

6. Barium Getter absorbs trace gases to properly maintain correct arc tube temperature and maximize light output.

7. Triple Coil Electrode with full tungsten support holds more emission paste for superior life. Tungsten supports prevent electrode vibration keeping emissive paste on the electrode.

8. Fuse Coil in lamp base provides additional protection to ballast. By preventing D.C. currents that may occur at end of lamp life, ballast currents are lower, ballast temperatures are lower and ballast life is longer.

Philips Lighting Company
200 Franklin Square Drive ■ P.O. Box 6800
Somerset, NJ 08875-6800
1-800-555-0050

www.lighting.philips.com/nam

A Division of Philips Electronics North America Corporation

Printed in USA 4/03

P-1785-C

Philips Lighting
281 Hillmount Road
Markham, Ontario
Canada L6C 2S3
1-800-555-0050
www.lighting.philips.com/nam
A Division of Philips Electronics Ltd.

Low Pressure Sodium Lamps (SOX-E and SOX)

Electrical, Technical and Ordering Data (Subject to change without notice)

Product Number	Ordering Code	ANSI Ballast Code	Operating on Ballast For	Nominal Lamp Watts	Nominal System Watts	Lumens	Nominal Lamp Volts	Nominal Lamp Current	Max. Starting Current	Rated Average Life (Hrs.)	Run Up Time (Minutes)
23404-7	SOX-E 18	L69	SOX 18	18		1800	55	0.36	0.42	18000	15
32781-7	SOX 35	L70	SOX 35	35	60	4550	70	0.6	0.60	18000	7
32151-3	SOX 55	L71	SOX 55	55	80	7800	109	0.59	0.59	18000	7
32152-1	SOX 90	L72	SOX 90	90	125	14300	112	0.91	0.94	18000	9
32153-9	SOX 135	L73	SOX 135	135	178	22600	164	0.95	0.95	18000	9
32799-9	SOX 180	L74	SOX 180	180	220	32000	240	0.91	0.91	18000	9

Operating Positions

Light Output Over Life 100%
Base Temperature Limit 150° C
Bulb Temperature Limit 150° C
Lamp Brightness (SOX) 10 cd/cm²

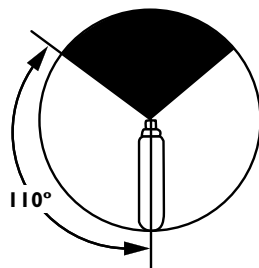

SOX-E 18
SOX 35
SOX 55

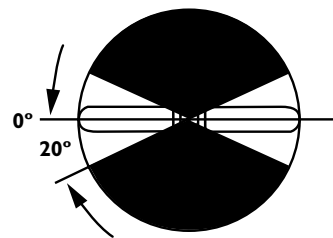

SOX 90
SOX 135
SOX 180





SOX



SOX-E

SOX(-E) low-pressure sodium vapour lamps have a U-shaped discharge tube, containing sodium, enclosed in an evacuated clear tubular outer bulb.

With their extremely high luminous efficacy they are the most efficient light sources for road lighting, security and tunnel lighting.

SOX-E

Compared with SOX lamps, the SOX-E lamps have reduced heat losses and hence an even higher lamp efficacy.

Unique dimples

The U-shaped discharge tube of SOX(-E) low-pressure sodium lamps is made of a special sodium-resistant glass with dimples to collect the sodium in the cooling stage. Thus, a uniform distribution of sodium along the discharge tube is achieved, which means a more stable discharge, a higher efficacy and a better lumen maintenance and lamp life.

A neon-argon mixture is added to facilitate starting.

The colour is monochromatic yellow, with colour rendering non-existent.

SOX(-E) lamps employ a ballast and an ignitor or a leak-transformer.

SOX(-E) and HF electronic gear

An even further improvement of the efficacy of SOX(-E) lamps can now be reached by operating these lamps on HF electronic gear: a nearly equal amount of light for 10 to 40% less energy. Next to that HF gear provides a zero influence from mains voltage variations on lamp parameters.

Burning positions

The burning position of the SOX 35 and 55 W and the SOX-E 18, 26 and 36 W types is vertical, base up with a tolerance of +/-110 degrees (when luminaires are installed in shock-free positions: universal burning position).

The SOX 90, 135 and 180 W and the SOX-E 66, 91 and 131 W have a horizontal burning position with a tolerance of +/-20 degs.

Applications

- Road lighting, marshalling yards, railway crossings, airports, harbours and docks, quarries, foundries and rolling mills.
- Security and orientation lighting.

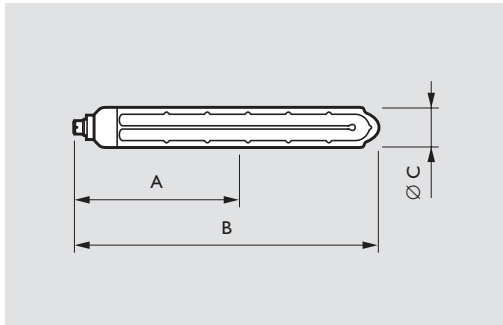

Dimensions in mm

Type	A max.	B max.	C max.
SOX 35W	183.0	311.0	52.0
SOX 55W	240.0	425.0	52.0
SOX 90W	291.0	528.0	68.0
SOX 135W	412.0	775.0	68.0
SOX 180W	580.0	1120.0	68.0
SOX-E 18	140.0	216.0	52.0
SOX-E 26	183.0	311.0	52.0
SOX-E 36	240.0	425.0	52.0
SOX-E 66	291.0	528.0	68.0
SOX-E 91	412.0	775.0	68.0
SOX-E 131	580.0	1120.0	68.0

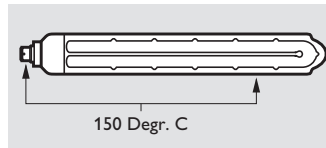

Max. permissible temperatures

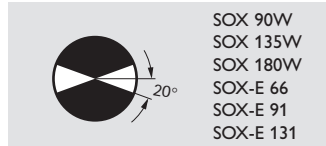

Burning positions

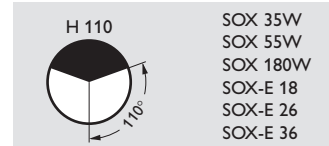

Type	Lamp wattage	Lamp voltage	Lumen output	Efficacy source	Average system power	Average system efficacy	Nett weight	Ordering number
	W	V	lm	lm/W	W ¹⁾	lm/W ¹⁾	g	
SOX on Philips hybride gear								
SOX 35W BY22D	37.0	70.00	4550.00	123.00	46	100	222.00	9281 455 00000
SOX 55W BY22D	56.0	109.00	7800.00	140.00	77	102	308.00	9281 460 00000
SOX 90W BY22D	89.0	112.00	13000.00	146.00	101	129	493.00	9281 465 00000
SOX 135W BY22D	129.0	164.00	20800.00	161.00	155	134	717.00	9281 470 00000
SOX 180W BY22D	180.0	240.00	32500.00	179.00	211	154	1044.00	9281 475 00000
SOX on Philips autoleak ballast								
SOX 35W BY22D	37.0	70.00	4550.00	130.00	57	84	222.00	9281 455 00000
SOX 55W BY22D	55.0	109.00	7800.00	147.00	76	105	308.00	9281 460 00000
SOX 90W BY22D	91.0	112.00	14000.00	154.00	119	113	493.00	9281 465 00000
SOX 135W BY22D	135.0	164.00	22600.00	167.00	165	136	717.00	9281 470 00000
SOX 180W BY22D	181.0	240.00	32000.00	176.00	216	153	1044.00	9281 475 00000
SOX-E on Philips optimal hybride gear								
SOX-E 18 BY22D	18.0	55.00	1770.00	99.00	26	69	150.00	9281 452 00000
SOX-E 26 BY22D	27.0	81.00	3700.00	137.00	33	112	222.00	9281 457 00000
SOX-E 36 BY22D	38.0	120.00	6160.00	160.00	48	122	308.00	9281 458 00000
SOX-E 66 BY22D	65.0	110.00	10700.00	165.00	81	133	493.00	9281 459 00000
SOX-E 91 BY22D	90.0	165.00	17000.00	189.00	108	158	717.00	9281 461 00000
SOX-E 131 BY22D	128.0	235.00	26000.00	203.00	150	173	1044.00	9281 451 00000
SOX-E on Philips hybrid gear for SOX								
SOX-E 26 BY22D	28.0	81.00	3500.00	125.00	40	88	222.00	9281 457 00000
SOX-E 36 BY22D	37.0	120.00	5800.00	157.00	57	102	308.00	9281 458 00000
SOX-E 66 BY22D	71.0	110.00	10500.00	148.00	92	114	493.00	9281 459 00000
SOX-E 91 BY22D	96.0	165.00	16000.00	167.00	127	126	717.00	9281 461 00000
SOX-E 131 BY22D	131.0	235.00	26000.00	198.00	167	156	1044.00	9281 451 00000
SOX-E on Philips autoleak ballast for SOX								
SOX-E 26 BY22D	27.0	81.00	3600.00	133.00	49	73	222.00	9281 457 00000
SOX-E 36 BY22D	39.0	120.00	6000.00	154.00	59	102	308.00	9281 458 00000
SOX-E 66 BY22D	67.0	110.00	10500.00	157.00	104	106	493.00	9281 459 00000
SOX-E 91 BY22D	101.0	165.00	18200.00	180.00	139	131	717.00	9281 461 00000
SOX-E 131 BY22D	140.0	235.00	27000.00	193.00	179	151	1044.00	9281 451 00000
SOX on Philips HF Electronic gear								
SOX 35W BY22D	33.0	-	4300.00	129.00	-	-	-	9281 455 00000
SOX 55W BY22D	51.0	-	7500.00	147.00	57	137	308.00	9281 460 00000
SOX-E on Philips HF Electronic gear								
SOX-E 36 BY22D	35.0	-	5800.00	166.00	38	153	308.00	9281 458 00000
SOX-E 66 BY22D	63.0	-	10700.00	170.00	68	157	493.00	9281 459 00000

¹⁾ After 100 burning hours.

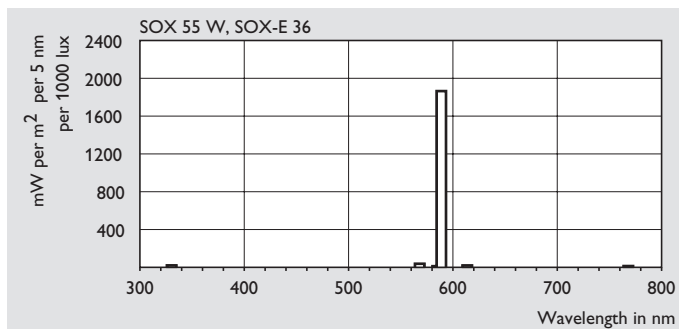

Spectral power distribution

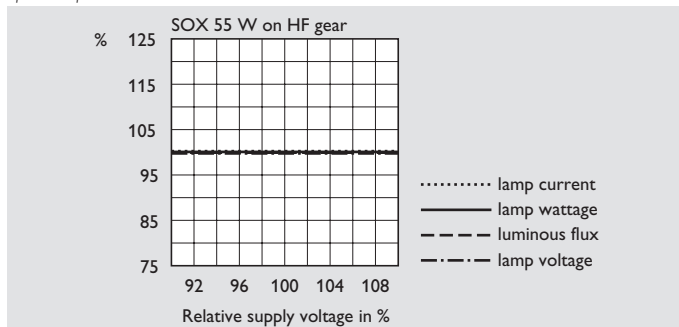

Effects of mains voltage variations

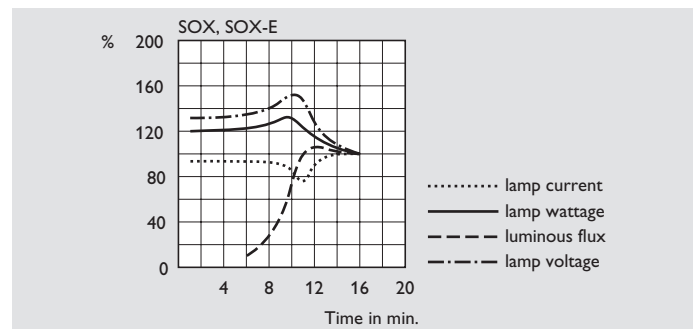

Lamp performance during run-up

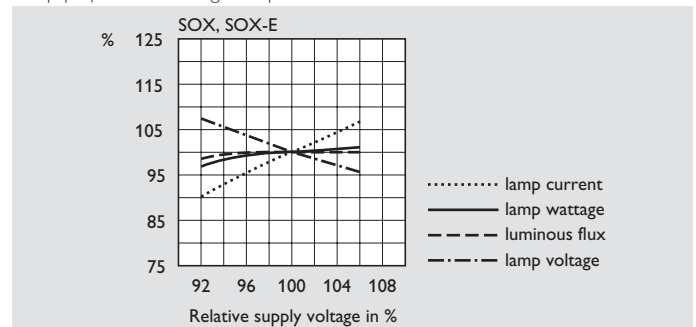

Effects of mains voltage variations