



HID

HIGH INTENSITY DISCHARGE BALLASTS

Core & Coil Ballasts

(60 Hz., Minimum Starting Temperature -40°F or -40°C)

High Pressure Sodium



Input Volts	Catalog [†] Number	Circuit Type	Watts Input	Max [•] Input Current	Nom Open Circuit Voltage	Fuse Rating (Amps)	Wiring Dia	Dimensions			Non-PCB Capacitor (Page 5-48 to 5-49)				Total Wt. (lbs)	Ignitor ^{††} (Page 5-50 to 5-53)		U.L. Bench Top Rise Code 1029 (pg 5-3)	
								Fig	A	B	Mfd	Min Volt	Cap Catalog Number	Dry or Oil		Part Number	Max Dist To Lamp (ft)		
100 Watt Lamp, ANSI Code S54																			
120	71A8007	R-NPF R-HPF	115	3.1 1.8	120	10 5	G	9	1.7	3.0	— 36	— 120	— 7C360M12	— D	2.5 2.8	LI551-H4	2	A	
120	71A8007-B 71A8007-001DB	R-NPF R-HPF	115	3.1 1.8	120	10 5	H	9	1.7	3.4	— 36	— 120	— 7C360M12	— D	2.5 2.8	Integral Ignitor	2	A/A	
120/277 220	71A8001 71A80J1	HX-HPF	130	2.2/.9 1.2	120	7/3 3	K	1	2.0	3.3	10	280	7C100M33-R	D	7.2	LI551-H4	2	C/C B	
480	71A8041 71A8041-001D	HX-HPF	130	.6	120	3	K	1	2.3	3.6	10	280	7C100M33-R	D	7.5	LI551-H4	2	E	
120/208/ 240/277	71A8091	HX-HPF	130	2.2/1.3/ 1.1/.9	120	7/5/ 3/3	K	1	2.0	3.6	10	280	7C100M33-R	D	7.2	LI551-H4	2	D/F/ D/D	
120/208/ 240/277	71A8071-001D	HX-HPF	130	2.2/1.3/ 1.1/.9	120	7/5/ 3/3	K	1	2.0	3.6	10	280	7C100M33-R	D	7.2	LI551-H4	2	D/F/ D/D	
120/ 277/347	71A80A1	HX-HPF	130	2.2/ .9/.7	120	7/ 3/3	K	1	2.3	3.6	10	280	7C100M33-R	D	7.5	LI551-H4	2	C/ C/D	
120/ 277/347	71A80A1-001D	HX-HPF	130	2.2/ .9/.7	120	7/ 3/3	K	1	2.3	3.6	10	280	7C100M33-R	D	7.5	LI551-H4	2	C/ C/D	
100 Watt Lamp, ANSI Code S105, (White SON-Philips) (Minimum Starting Temperature -20°F or -30°C)																			
120	71A8005	Hybrid Electronic	120	2.2	120	5	R	9	2.0	3.2	45	120	7C450P12	D	5.5	6C100 Controller	2	A	
120/277 ••	71A8005 ^(120V) + 71A9876 ^(120/277V) Auto transformer)	Hybrid Electronic AR	125	1.0	120	5/3	S	9 (2pcs)	2.0	3.2	45	120	7C450P12	D	9.5	6C100 Controller	2	A/A	

† Ordering information:

Replacement/retrofit ballast kits indicated by **bold type** with suffix -001D(B). Refer to pages 5-5 to 5-9.

Original equipment ballasts - add proper suffix to catalog number:

- 500D includes core & coil with dry-film capacitor
- 510D includes core & coil with welded bracket and dry-film capacitor
- 600 core & coil only (no capacitor)
- 610 core & coil with welded bracket (no capacitor) (71A8007 Only)

• For AR, HX, R and Hybrid circuits, figure is highest of starting, operating or open circuit currents.

†† Each ballast requiring an ignitor is furnished standard with the **Short Range** ignitor model shown for use within fixtures. If a **Long Range** ignitor is required for remote mounting, specify on order. **Instant Restrike** ignitor also available (excludes 71A8005, 71A8007-B, 71A80J1 and 71A8041). See pages 5-50 to 5-53 for additional information.

•• 277V operation requires the 120V reactor ballast and controller plus the 120/277V auto-transformer listed. Ballast dimensions shown in table are for the reactor ballast component only. See page 5-54 for auto-transformer specifications and dimensions.

• Canadian replacement/retrofit ballast kit indicated by **bold type**. Refer to page 5-10.

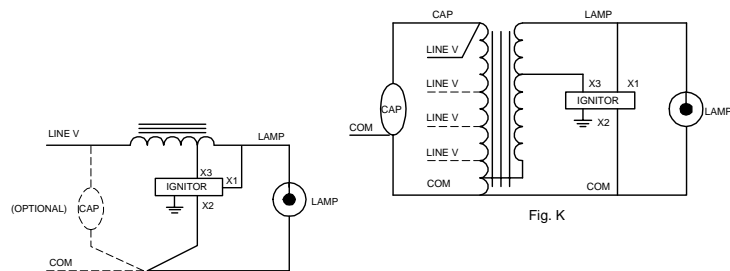

Fig. G

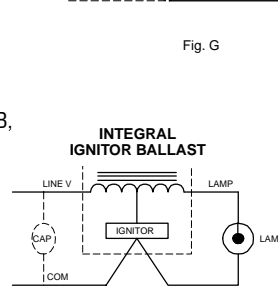

Fig. H

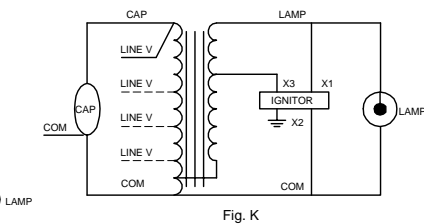
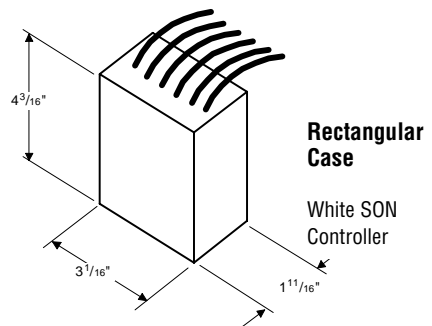

Fig. K



Rectangular Case

White SON Controller



HIGH INTENSITY DISCHARGE BALLASTS

Encapsulated Core & Coil

Where quiet performance is required, the standard open core & coil ballasts are encapsulated (potted) in a cube-shaped steel can utilizing Class H (180°C) polyester compound. These ballasts carry a Class A noise rating up through 175 watts and Class B for 250 and 400 watts. As with the open core & coil, the capacitor (and ignitor where included) are mounted separately within the fixture.

Fluorescent Can (F-Can)

For indoor commercial applications of HID lighting such as offices, schools and retail stores, ballast noise must be minimized. Ballasts for these fixtures are most often encased and potted in fluorescent ballast type cans and utilize Class A (90°C) asphalt insulating materials (the same as used in fluorescent lamp ballasts).

The Advance line of F-can ballasts comes in two dual-voltage configurations: 120/277 volt for the US market, and 120/347 volt for the Canadian market. Each unit has built-in, automatically resetting, thermal protectors which disconnect the ballast from the power line in the event of overheating. All units are high power factor and include the capacitor within the can. All models for high pressure sodium, low-wattage metal halide, and pulse-start metal halide lamps also include the ignitor in the can.

Indoor Enclosed

These units are designed for use indoors where the ballast must be mounted remotely from the luminaire. They are most typically used in factories where the luminaire may be mounted in a high-bay where very high ambient temperatures may be experienced. In these instances, the remotely-mounted ballast operates cooler, subsequently providing longer life because it is away from both the heat of the ceiling ambient and lamp heat within the fixture.

The case contains the core & coil potted in a Class H (180°C) heat-dissipating resin. The capacitor(s) and ignitor are contained within a separate compartment. Knockouts in both ends of the case facilitate hook-up in the most convenient manner. Wall mounting is accomplished through flanges on the top and bottom of the case. The ballast is a UL Listed product.

Outdoor Weatherproof

Weatherproof ballasts are designed for remote, pole-mounting outdoor applications under all weather conditions. They may also be placed inside of a transformer pole base, but care must be taken to avoid areas prone to flooding because weatherproof ballasts are not water-submersible.

The core & coil with its capacitor and ignitor (where required) are firmly mounted to the heat-sink base. An aluminum cover is placed over the core-&-coil assembly and is bolted with a weather-tight gasket to the base. An integral 1" threaded nipple with locknut facilities hook-up to electrical conduit or to the mounting bracket when used on a pole. The weatherproof ballast may also be placed nipple-up, with a drip loop in the leads, inside a pole base.

Postline

Lantern-type fixtures mounted on slender poles often require ballasts which will fit into these poles. Special, elongated core & coil ballasts are potted in resin in cylindrical cans having a 2.55" outside diameter. All include leads necessary for direct connection to a photocell.

The capacitor and ignitor (where required) are included within this can. A 1/2" threaded nipple is used for vertical mounting, and leads extend from both ends of the can for ease of installation. The input leads to the ballast also provide for proper connection to the photocell if such is included within the fixture.

To help prevent overheating, one to three feet of air space should be allowed in the pole above the ballast, and the ballast should be positioned against the post interior wall to provide a heat-sink. All units rated 100W and above now include a mounting kit consisting of an 18" chain to hang the ballast within the pole and a spring clip to force the ballast's cylindrical can to make line contact with the pole's interior surface to maximize heat transfer, thus prolonging the ballast life.

BALLAST DATE AND TEMPERATURE CODES

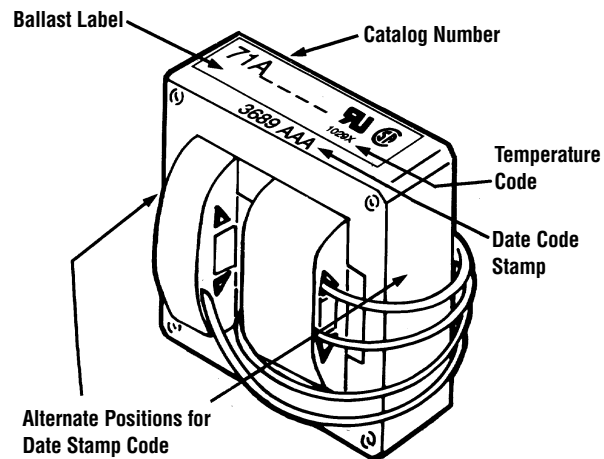

ADVANCE® HID Core & Coil ballasts are date stamped on either the top surface or the side surface of the ballast core. The four-digit number represents the *week* and *year* of manufacture. The first two numbers indicate the week and the last two indicate the year the ballast was manufactured. The example shows a ballast manufactured during the 36th week of 1989. The three letters are an Advance factory code. The ballast's UL Bench Top Rise Temperature Code is shown on the label (see below).

UL BENCH TOP RISE TEMPERATURE CODE

To facilitate UL inspection, each ballast's UL Bench Top Rise Temperature Code is shown on the Advance Core & Coil ballast label as 1029X, where 1029 is the UL Standard for HID Ballasts, and the X is the temperature code: A, B, C, etc. If a fixture is UL listed for 1029C, then automatically, all ballasts with an A, B, or C temperature classification are acceptable for use within that same fixture.

UL Bench Top Rise Letter Code	Temperature Range for Class H (180°C) Ballasts	Temperature Range for Class N (200°C) Ballasts
A	less than 75°C	less than 95°C
B	75°C < 80°C	95°C < 100°C
C	80°C < 85°C	100°C < 105°C
D	85°C < 90°C	105°C < 110°C
E	90°C < 95°C	110°C < 115°C
F	95°C < 100°C	115°C < 120°C
etc.	etc.	etc.

CERTIFICATIONS



Indicates ballast is listed by Underwriters Laboratories, Inc. in accordance with UL 1029 Standard for HID Ballasts. Each ballast is marked appropriately.



Indicates ballast is component recognized by Underwriters Laboratories, Inc. in accordance with UL 1029 Standard for HID Ballasts. Each ballast is marked appropriately.



Indicates ballast is certified by Canadian Standards Association in accordance with CAN/CSA-22.2 No. 74-92. Each ballast is marked appropriately.



All HID Ballasts are designed and manufactured in accordance with the American National Standards Institute Standard for HID Ballasts, ANSI C82.4.



HIGH INTENSITY DISCHARGE BALLASTS

ORDERING INFORMATION

How to Order

Advance Transformer has developed the industry's broadest selection of HID ballasts. More than 3000 stocking distributors nationwide. For information on the distributor best able to serve your needs, please call 800-372-3331.

Advance HID Ballast Part Number Explanation

71A	60	9	1	-500D								
<p>Suffix Code* (as applicable)</p> <ul style="list-style-type: none"> -001DB ballast replacement kit with dry capacitor and integral ignitor -001D ballast replacement kit with dry film capacitor -001 ballast replacement kit with oil filled capacitor -500D core & coil ballast with dry film capacitor -500 core & coil ballast with oil filled capacitor -510D core & coil ballast with welded bracket and dry film capacitor -510 core & coil ballast with welded bracket and oil filled capacitor -540D core & coil ballast with welded angle bracket and dry film capacitor -600 core & coil ballast (no capacitor) -610 core & coil ballast with welded bracket (no capacitor) <p>* Add additional feature codes to the end of suffix where applicable. i.e. -B = Integral Ignitor, -P = Thermally Protected, -J = J-Box Mounting</p>												
Design Code												
<table style="width: 100%; border: none;"> <tr> <td style="width: 30%;"></td> <td style="text-align: center;">60 Hz Voltages</td> <td style="width: 40%;"></td> <td style="text-align: center;">50 Hz Voltages</td> </tr> <tr> <td style="vertical-align: top;">INPUT VOLTAGE CODE</td> <td style="vertical-align: top;"> <ul style="list-style-type: none"> 0 = 120V 1 = 208V 2 = 240V 3 = 277V 4 = 480V 5 = 120/240V or 120/208/240/277/480V 6 = 240/480V 7 = 120/208/240/277V 8 = 120/277V 9 = 120/208/240/277V </td> <td style="vertical-align: top;"> <ul style="list-style-type: none"> A = 120/277/347V B = 347V C = 120/347V D = 120/240/347V E = 120/208/240V or 208/240V F = 277/480V, 277/347V, 277/347/480V or 347/480V H = 127/220V J = 220V or 220/240V Y = 100V or 100/200V </td> <td style="vertical-align: top;"> <ul style="list-style-type: none"> M = 100/200V N = 120/220-240V R = 220/240V </td> </tr> </table>						60 Hz Voltages		50 Hz Voltages	INPUT VOLTAGE CODE	<ul style="list-style-type: none"> 0 = 120V 1 = 208V 2 = 240V 3 = 277V 4 = 480V 5 = 120/240V or 120/208/240/277/480V 6 = 240/480V 7 = 120/208/240/277V 8 = 120/277V 9 = 120/208/240/277V 	<ul style="list-style-type: none"> A = 120/277/347V B = 347V C = 120/347V D = 120/240/347V E = 120/208/240V or 208/240V F = 277/480V, 277/347V, 277/347/480V or 347/480V H = 127/220V J = 220V or 220/240V Y = 100V or 100/200V 	<ul style="list-style-type: none"> M = 100/200V N = 120/220-240V R = 220/240V
	60 Hz Voltages		50 Hz Voltages									
INPUT VOLTAGE CODE	<ul style="list-style-type: none"> 0 = 120V 1 = 208V 2 = 240V 3 = 277V 4 = 480V 5 = 120/240V or 120/208/240/277/480V 6 = 240/480V 7 = 120/208/240/277V 8 = 120/277V 9 = 120/208/240/277V 	<ul style="list-style-type: none"> A = 120/277/347V B = 347V C = 120/347V D = 120/240/347V E = 120/208/240V or 208/240V F = 277/480V, 277/347V, 277/347/480V or 347/480V H = 127/220V J = 220V or 220/240V Y = 100V or 100/200V 	<ul style="list-style-type: none"> M = 100/200V N = 120/220-240V R = 220/240V 									
Lamp Type/Wattage/Ballast Circuit Code												
Ballast Type	<ul style="list-style-type: none"> 71A = Core and Coil Ballast 72C = F-Can Ballast 73B = Encapsulated Core and Coil Ballast 74P = Postline Ballast 77K = Val-U-Pak Replacement Ballast Kit 77L = Val-U-Pak Plus Replacement Ballast kit (includes lamp) 78E = Indoor Enclosed Ballast 79W = Outdoor Weatherproof Ballast 											



HIGH INTENSITY DISCHARGE BALLASTS

Core & Coil Ballasts

(60 Hz., Minimum Starting Temperature -40°F or -40°C)

HID



High Pressure Sodium

Input Volts	Catalog † Number	Circuit Type	Watts Input	Max Input Current	Nom Open Circuit Voltage	Fuse Rating (Amps)	Wiring Dia	Dimensions			Non-PCB Capacitor (Page 5-48 to 5-49)				Ignitor †† (Page 5-50 to 5-53)		U.L. Bench Top Rise Code 1029 (pg 5-3)	
								Fig	A	B	Mfd	Min Volt	Cap Catalog Number	Dry or Oil	Total Weight (lbs)	Part Number		Max Dist To Lamp (ft)
100 Watt Lamp, ANSI Code S54																		
120/277	71A8088	CWA	138	1.2/.5	115	3/2	M	1	2.0	3.3	34	170	7C340P24	D	7.5	LI551-J4	5	F/F
127/220	71A80H8			1.1/.7		3/2												E/D
480/120T	71A8048-T			.3		1												
120/208/240	71A80E6	CWI	130	1.2/.7/.6	110	3/2/2	V	1	2.1	3.4	35	170	7C350P24	D	6.8	LI551-J4	2	C/C/B
120/240	71A8050	Regulated Lag	138	1.2/.6	120	3/2	N	2	1.4	3.0	16	330	7C160M33	D	8.5	LI551-H4	2	A/A
120/277	71A8080			1.2/.6		3/2												A/A
240/480	71A8060			.6/.3		1.5/1												A/A

† Ordering information:

Original equipment ballasts - add proper suffix to catalog number:

- 500D includes core & coil with dry-film capacitor
- 510D includes core & coil with welded bracket and dry-film capacitor
- 600 core & coil only (no capacitor)
- 610 core & coil with welded bracket (no capacitor)

• For CWA, CWI and Regulated Lag circuits, figure is operating current.

†† Each ballast requiring an ignitor is furnished standard with the **Short Range** ignitor model shown for use within fixtures. If a **Long Range** ignitor is required for remote mounting, specify on order. See pages 5-50 to 5-53 for additional information.

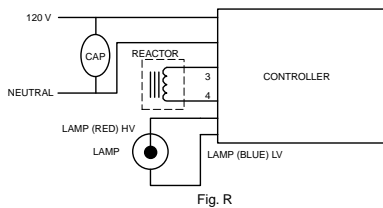

Fig. R

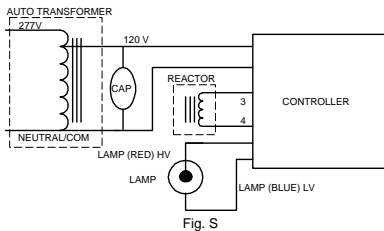

Fig. S

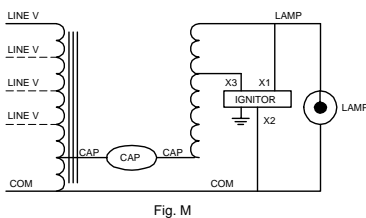

Fig. M

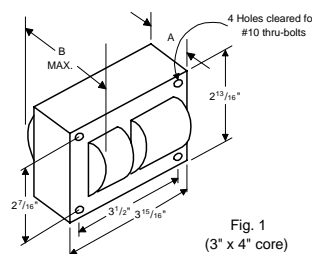

Fig. 1
(3" x 4" core)

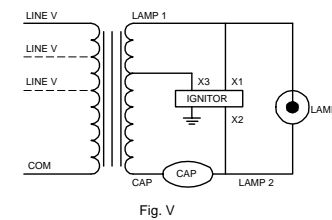

Fig. V

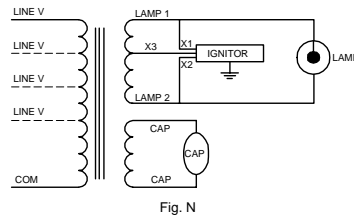

Fig. N

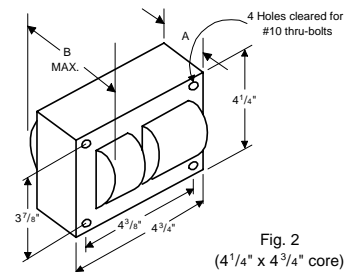

Fig. 2
(4 1/4" x 4 3/4" core)

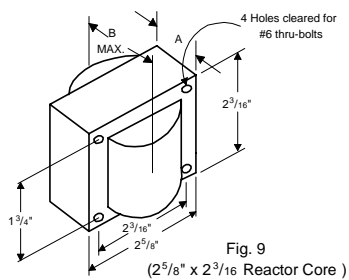
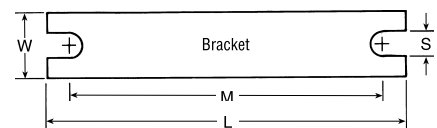

Fig. 9
(2 5/8" x 2 3/16" Reactor Core)



WELDED BRACKET DIMENSIONS

Ballast Dimensions Fig	L	W	M	S
1	5.1	1.00	4.50	0.25
2	6.5	1.25	5.75	0.28
9	4.0	0.75	3.50	0.28

HID • CORE & COIL
HPS

