



# PL-S Short 2-Pin Base

PL-S ALTO 5W/841 G23/2P 1CT

Philips Linear Compact Fluorescent Lamps offer designers, specifiers and end-users new levels of efficiencies and versatility in sizes, configurations and application possibilities. With so many elegant fixtures available to complement their small size, high light output and advanced technology, Philips Energy Advantage lamps are fast becoming the preferred choice when maximum efficiency and sleek design solutions are required.

## Product data

### • General Characteristics

Base	G23 [Two-Pin Compact Fluorescent; low preheat current; two retainers]
Base Information	2P
Avg. Life	10000 hr
Life to 10% failures EM	6500 hr
LSF EM 8000h Rated, 3h cycle	86 %
LSF EM 6000h Rated, 3h cycle	95 %
LSF EM 4000h Rated, 3h cycle	98 %
LSF EM 2000h Rated, 3h cycle	99 %

### • Light Technical Characteristics

Color Code	841 [CCT of 4100K]
Color Rendering Index	82 Ra8
Color Designation	Cool White
Color Temperature	4100 K
Chromaticity Coordinate X	381 -
Chromaticity Coordinate Y	379 -
Lum Efficacy Rated EM 25°C	48 Lm/W
LLMF EM 8000h Rated	77 %
LLMF EM 6000h Rated	80 %
LLMF EM 4000h Rated	83 %
LLMF EM 2000h Rated	89 %

Luminous Flux EM 25°C, Rated	259 Lm
Luminous Flux EM 25°C, Nominal	250 Lm
Design Temperature	28 C

### • Electrical Characteristics

Watts	5 W
Dimmable	No
Lamp Current EM 25°C	0.180 A
Lamp Wattage EM 25°C, Rated	5.4 W
Lamp Wattage EM 25°C, Nominal	5 W
Lamp Voltage EM 25°C	35 V

### • Environmental Characteristics

Energy Efficiency Label (EEL)	B
Mercury (Hg) Content	1.4 mg

### • Product Dimensions

Base Face to Base Face A	67 (max) mm
Insertion Length B	83 (max) mm
Overall Length C	105 (max) mm
Diameter D	28 (max) mm
Diameter D1	13 (max) mm

# PHILIPS

sense and simplicity

# PL-S Short 2-Pin Base

## Product Data

Product number 148684  
 Full product name PL-S ALTO 5W/841 G23/2P 1CT  
 Short product name PL-S 5W/841/2P/ALTO 10PK  
 Pieces per Sku 1  
 eop\_pck\_cfg 10

Skus/Case 10  
 Bar code on pack 46677148683  
 Bar code on case 50046677148688  
 Logistics code(s) 927900684121  
 tpd\_ilcos\_cd FSD-5/40/1B-I-G23  
 eop\_net\_weight\_pp 22.000 gr

## Dimensional drawing

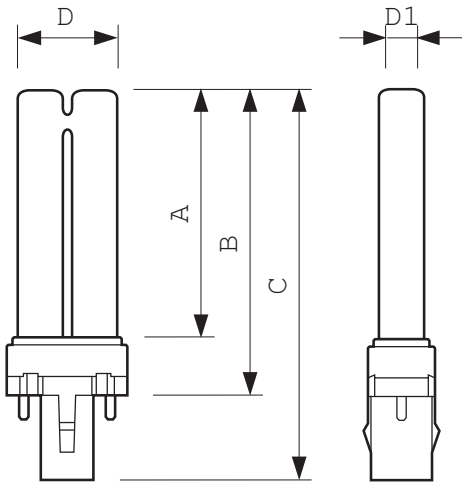

## G23/GX23, 2P

Product	A (Max)	B (Max)	C (Max)	D (Max)	D1 (Max)
PL-S ALTO 5W/841/2P	67	83	105	28	13

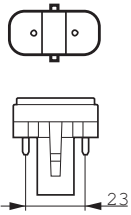

G23

## Photometric data

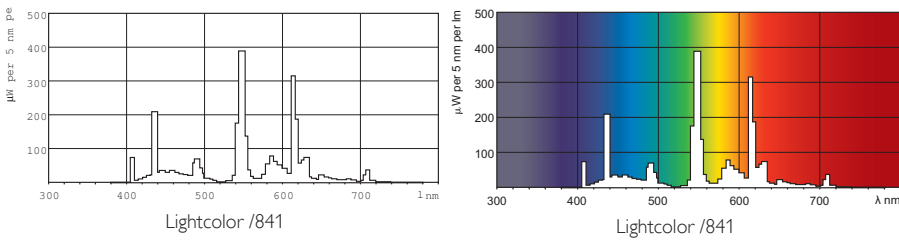

© 2012 Koninklijke Philips Electronics N.V.  
 All rights reserved.

Specifications are subject to change without notice. Trademarks are the property of Koninklijke Philips Electronics N.V. or their respective owners.

[www.philips.com/lighting](http://www.philips.com/lighting)

2012, August 4  
 data subject to change