



# LEDtube Internal Standard

LED T8 Tube 48in 22W 865 G13 Ext Driver

Philips LEDtube INTERNAL STANDARD integrates a LED light source into a traditional fluorescent form factor. This product is the ideal solution for uplampping in general lighting applications: it meets basic lighting requirements, offers significant energy savings, and is environmentally friendly.

## Product data

### • General Characteristics

Cap-Base G13

### • Light Technical Characteristics

Color Code 865  
Correlated Color Temperature 6500 K  
Approximate Lumens 2500 Lm  
Approx. MBCP 0 cd  
CRI 85

### • Electrical Characteristics

Wattage 22 W  
Voltage 120-277 V

### • Product Dimensions

Length A1 1200.0 mm

### • Approval & Application Chars

VDE marking No  
CE marking No  
KEMA Keur certificate No

### • Product Data

Product number 427211  
Full product name LED T8 Tube 48in 22W 865 G13 Ext Driver  
Short product name 22T8/EXT/48-6500K UNV  
Pieces per Sku 1  
eop\_pck\_cfg 10  
Skus/Case 10  
Bar code on pack 46677427214  
Bar code on case 50046677427219  
Logistics code(s) 929000297204  
eop\_net\_weight\_pp 0.001 kg



## Dimensional drawing

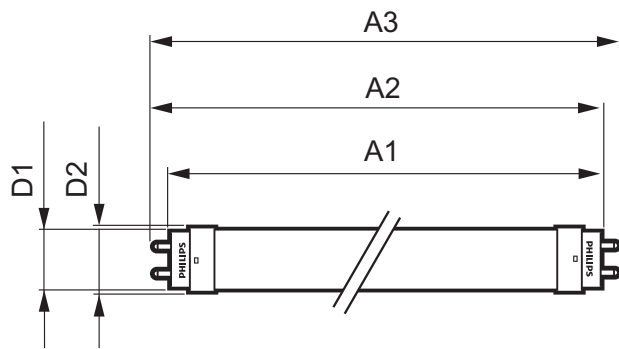

LED T8 Tube 48in 22W 865 G13 Ext Driver

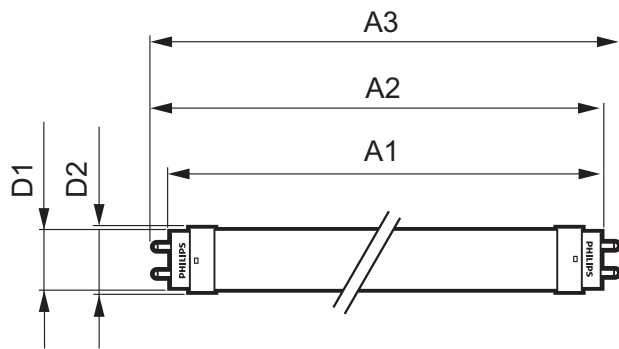

LED T8 Tube 48in 22W 865 G13 Ext Driver

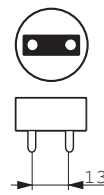

G13



© 2013 Koninklijke Philips Electronics N.V.  
All rights reserved.

Specifications are subject to change without notice. Trademarks are the property of Koninklijke Philips Electronics N.V. or their respective owners.

[www.philips.com/lighting](http://www.philips.com/lighting)

2013, January 23  
data subject to change