

Standard Product Selection Matrix

Description	2.50 x 2.50 in. (64 x 64 mm)	3.00 x 3.00 in. (76 x 76 mm)	4.00 x 4.00 in. (102 x 102 mm)	6.00 x 6.00 in. (152 x 152 mm)	8.00 x 8.00 in. (203 x 203 mm)	10.00 x 10.00 in. (254 x 254 mm)	12.00 x 12.00 in. (305 x 305 mm)
12.00-in. (305-mm) Straight Section with knockouts	F22T112GVPWK	—	F44T112GVPWK	F66T112GVPWK	F88T112GVPWK	—	F1212T112GVPWK
12.00-in. (305-mm) Straight Section without knockouts	F22T112GVP	—	F44T112GVP	F66T112GVP	F88T112GVP	F1010T112GVP	F1212T112GVP
18.00-in. (455-mm) Straight Section without knockouts	—	—	F44T118GVP	F66T118GVP	F88T118GVP	—	—
24.00-in. (610-mm) Straight Section with knockouts	F22T124GVPWK	—	F44T124GVPWK	F66T124GVPWK	F88T124GVPWK	—	F1212T124GVPWK
24.00-in. (610-mm) Straight Section without knockouts	F22T124GVP	—	F44T124GVP	F66T124GVP	F88T124GVP	F1010T124GVP	F1212T124GVP
36.00-in. (914-mm) Straight Section with knockouts	F22T136GVPWK	—	F44T136GVPWK	F66T136GVPWK	F88T136GVPWK	—	F1212T136GVPWK
36.00-in. (914-mm) Straight Section without knockouts	F22T136GVP	—	F44T136GVP	F66T136GVP	F88T136GVP	F1010T136GVP	F1212T136GVP
48.00-in. (1219-mm) Straight Section with knockouts	F22T148GVPWK	—	F44T148GVPWK	F66T148GVPWK	F88T148GVPWK	—	F1212T148GVPWK
48.00-in. (1219-mm) Straight Section without knockouts	F22T148GVP	—	F44T148GVP	F66T148GVP	F88T148GVP	F1010T148GVP	F1212T148GVP
60.00-in. (1524-mm) Straight Section with knockouts	F22T160GVPWK	—	F44T160GVPWK	F66T160GVPWK	F88T160GVPWK	—	F1212T160GVPWK
60.00-in. (1524-mm) Straight Section without knockouts	F22T160GVP	F33T160GVP	F44T160GVP	F66T160GVP	F88T160GVP	F1010T160GVP	F1212T160GVP
72.00-in. (1829-mm) Straight Section with knockouts	—	—	F44T172GVPWK	F66T172GVPWK	—	—	—
72.00-in. (1829-mm) Straight Section without knockouts	—	—	F44T172GVP	F66T172GVP	F88T172GVP	F1010T172GVP	—
120.00-in. (3048-mm) Straight Section with knockouts	F22T1120GVPWK	—	F44T1120GVPWK	F66T1120GVPWK	F88T1120GVP	—	—
120.00-in. (3048-mm) Straight Section without knockouts	F22T1120GVP	F33T1120GVP	F44T1120GVP	F66T1120GVP	F88T1120GVP	F1010T1120GVP	F1212T1120GVP
90° Flush Tee	F22GT	F33GT	F44GT	F66GT	F88GT	F1010GT	F1212GT
Sweep Tee	F22T	—	F44T	F66T	F88T	F1010T	F1212T
Cross Fitting	F22X	—	F44X	F66X	F88X	F1010X	F1212X
90° Sweep Elbow	F22G90SE	—	F44G90SE	F66G90SE	F88G90SE	F1010G90SE	F1212G90SE
90° Elbow-Tee-Cross	F22G90TX	F33G90TX	F44G90TX	F66G90TX	F88G90TX	F1010G90TX	F1212G90TX
90° Elbow	F22G90E	F33G90E	F44G90E	F66G90E	F88G90E	F1010G90E	F1212G90E
90° Elbow Outside Opening	F2290EOUT	—	F4490EOUT	F6690EOUT	F8890EOUT	F101090EOUT	F121290EOUT
90° Elbow Inside Opening	F2290EIN	—	F4490EIN	F6690EIN	F8890EIN	F101090EIN	F121290EIN
45° Elbow	F22G45E	F33G45E	F44G45E	F66G45E	F88G45E	F1010G45E	F1212G45E
Telescope Fitting ^a	F22GA	—	F44GA	F66GA	F88GA	F1010GA	F1212GA
Open Adapter	F22GOA	—	F44GOA	F66GOA	F88GOA	F1010GOA	F1212GOA
Panel Adapter	F22GPA	F33GPA	F44GPA	F66GPA	F88GPA	F1010GPA	F1212GPA
Closure Plate with knockouts	F22GCP	—	F44GCP	F66GCP	F88GCP	F1010GCP	F1212GCP
Closure Plate without knockouts	F22GCPNK	F33GCPNK	F44GCPNK	F66GCPNK	F88GCPNK	F1010GCPNK	F1212GCPNK
Reducer	—	F33G22R	F44G22R	F66G44R	F88G66R	F1010G88R	F1212G1010R
Drop and Bracket Hanger	F22GDB	—	F44GDB	F66GDB	F88GDB	F1010GDB	F1212GDB
Support Hanger	F22GSH	—	F44GSH	F66GSH	F88GSH	F1010GSH	F1212GSH
Universal U-Connector	F22GUC	F33GUC	F44GUC	F66GUC	F88GUC	F1010GUC	F1212GUC
Barrier Kit, bolt-on Each barrier 60.00 in. (1524 mm)	—	F33BK60	F44BK60	F66BK60	F88BK60	—	—

^aNot UL/cUL listed.

STRAIGHT SECTION

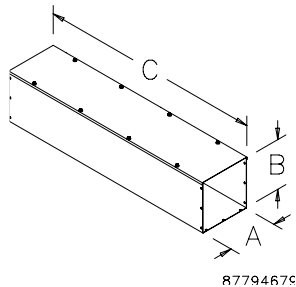

Protects electrical wiring in applications where dust, dirt, oil and water are not serious problems. All sections and fittings are completely open on one side so wires and cables can be laid in along wireway run. No pulling through of wires or cables prevents damage to insulation that often occurs in a pull-through wiring system. Flat cover design allows for mounting flush with walls or ceilings. Keyhole screw slots on flat covers provide easy access.

BULLETIN: F40FC, F40G

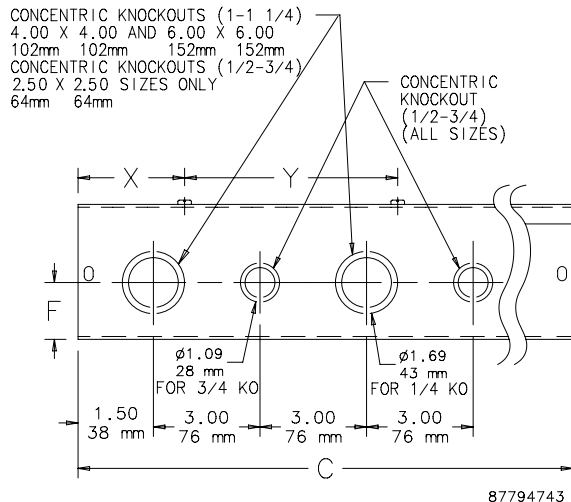

PATTERN REPEATS EVERY 12.00
305 mm