

Cooling Fan and Exhaust Packages and Accessories

Cooling Fan and Exhaust Packages

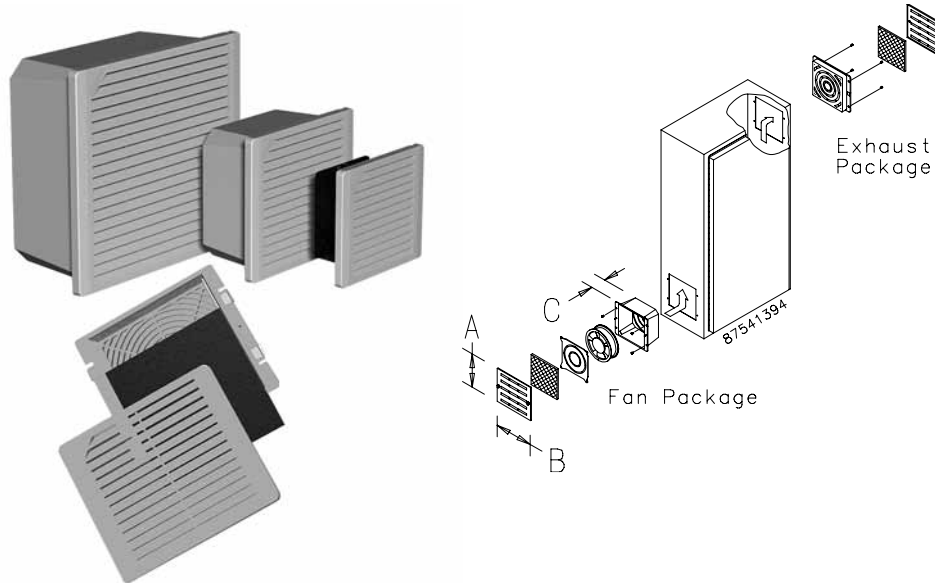

Industry Standards

UL 508A Component Recognized, File Number E61997 TFP# Models: Type 1 TFP# UL 12 Models: Type 12

CSA certified (fan only)
CE

Application

Cooling Fan and Exhaust Packages are designed for limited-space enclosures that require a reliable and filtered airflow. Where positive airflow is not required, Exhaust Packages can be used on both the inlet and outlet.

Engineered for 50,000 hours of continuous operation without lubrication or service. For both Type 1 and Type 12 systems a monthly maintenance schedule is recommended to ensure optimal cooling performance.

Features

- Cooling Fan Package includes fan, air filter, composite air plenum, finger guard and grille
- Exhaust Package includes air filter, filter retainer with integral finger guard and grille
- EMC Upgrade Kit includes a grille standoff collar and a special EMC shielding grille
- Washable foam (Type 1) or disposable (Type 12) filter in fan. Optional washable aluminum air filter is available for Type 1 applications.
- Dynamically-balanced fan impellers molded from polycarbonate material
- 4-in. fan is thermally protected and uses permanently-lubricated ball bearings
- 6- and 10-in. fans have ball bearing construction and split-capacitor motors that are thermally protected to avoid premature failure
- Fans have leadwires for power connection with ends stripped 1/2 in. (12 mm)
- All mounting hardware and installation instructions are furnished

Filters

Standard Type 1 air filters are washable foam.
Type 12 air filters are not washable.

Installation

Fan and exhaust packages can be installed on any surface of an enclosure. They are most effective when the fan assembly is located on a lower panel of the enclosure and the exhaust grille is positioned near the top of the opposite side. This installation assists heat transfer by causing slightly more turbulence and also prolongs the working life of the fan since it is located in the path of the cooler air entering the enclosure.

The height and width of the cooling fans and exhaust grilles can be rotated 90 degrees for mounting on narrow enclosures. Allow adequate clearance for servicing the fan when equipment is installed inside the enclosure and for replacing filters on both the fan and the exhaust. Cutout dimensions for both the fan and the exhaust are shown in the order table. Order the fan and exhaust packages separately.

Finish

Stainless steel grilles have brushed finish.
ABS composite grille is black.

Accessories

Aluminum Type 1 and Hi-Density Type 12 Filters
EMC Upgrade Kit
Grille Options:
Stainless Steel
Black ABS Plastic

Bulletin: D85

Cooling Fan and Exhaust Packages and Accessories

Standard Product and Cutout Dimensions Cooling Fan and Exhaust Packages

Catalog Number	AxBxC in./mm	Material and Type	Use with Exhaust Grille	Nominal Fan Size	D in./mm	F in./mm	H in./mm	T in./mm	W in./mm
TFP424	6.29 x 7.37 x 2.35 160 x 187 x 67	Composite Grille UL 508 Type 1	TEP4	4	0.45 11	5.66 144	0.77 20	4.12 105	6.39 162
TFP41	6.29 x 7.37 x 2.65 160 x 187 x 67	Composite Grille UL 508 Type 1	TEP4	4	0.45 11	5.66 144	0.77 20	4.12 105	6.39 162
TFP41SS	6.29 x 7.37 x 2.65 160 x 187 x 67	Stainless Steel Grille UL 508 Type 1	TEP4SS	4	0.45 11	5.66 144	0.77 20	4.12 105	6.39 162
TFP41UL12	6.29 x 7.37 x 2.65 160 x 187 x 67	Composite Grille UL 508 Type 12	TEP4UL12	4	0.45 11	5.66 144	0.77 20	4.12 105	6.39 162
TFP42	6.29 x 7.37 x 2.65 160 x 187 x 67	Composite Grille UL 508 Type 1	TEP4	4	0.45 11	5.66 144	0.77 20	4.12 105	6.39 162
TFP42SS	6.29 x 7.37 x 2.65 160 x 187 x 67	Stainless Steel Grille UL 508 Type 1	TEP4SS	4	0.45 11	5.66 144	0.77 20	4.12 105	6.39 162
TFP42UL12	6.29 x 7.37 x 2.65 160 x 187 x 67	Composite Grille UL 508 Type 12	TEP4UL12	4	0.45 11	5.66 144	0.77 20	4.12 105	6.39 162
TFP624	7.80 x 8.87 x 3.75 198 x 225 x 95	Composite Grille UL 508 Type 1	TEP6	6	0.49 12	7.16 182	1.33 34	4.50 114	7.89 200
TFP61	7.80 x 8.87 x 3.75 198 x 225 x 95	Composite Grille UL 508 Type 1	TEP6	6	0.49 12	7.16 182	1.33 34	4.50 114	7.89 200
TFP61SS	7.80 x 8.87 x 3.75 198 x 225 x 95	Stainless Steel Grille UL 508 Type 1	TEP6SS	6	0.49 12	7.16 182	1.33 34	4.50 114	7.89 200
TFP61UL12	7.80 x 8.87 x 3.75 198 x 225 x 95	Composite Grille UL 508 Type 12	TEP6UL12	6	0.49 12	7.16 182	1.33 34	4.50 114	7.89 200
TFP62	7.80 x 8.87 x 3.75 198 x 225 x 95	Composite Grille UL 508 Type 1	TEP6	6	0.49 12	7.16 182	1.33 34	4.50 114	7.89 200
TFP62SS	7.80 x 8.87 x 3.75 198 x 225 x 95	Stainless Steel Grille UL 508 Type 1	TEP6SS	6	0.49 12	7.16 182	1.33 34	4.50 114	7.89 200
TFP62UL12	7.80 x 8.87 x 3.75 198 x 225 x 95	Composite Grille UL 508 Type 12	TEP6UL12	6	0.49 12	7.16 182	1.33 34	4.50 114	7.89 200
TFP101	11.81 x 12.99 x 5.25 300 x 330 x 133	Composite Grille UL 508 Type 1	TEP10	10	0.55 14	11.16 283	2.14 54	6.88 175	11.89 302
TFP101SS	11.81 x 12.99 x 5.25 300 x 330 x 133	Stainless Steel Grille UL 508 Type 1	TEP10SS	10	0.55 14	11.16 283	2.14 54	6.88 175	11.89 302
TFP101UL12	11.81 x 12.99 x 5.25 300 x 330 x 133	Composite Grille UL 508 Type 12	TEP10UL12	10	0.55 14	11.16 283	2.14 54	6.88 175	11.89 302
TFP102	11.81 x 12.99 x 5.25 300 x 330 x 133	Composite Grille UL 508 Type 1	TEP10	10	0.55 14	11.16 283	2.14 54	6.88 175	11.89 302
TFP102SS	11.81 x 12.99 x 5.25 300 x 330 x 133	Stainless Steel Grille UL 508 Type 1	TEP10SS	10	0.55 14	11.16 283	2.14 54	6.88 175	11.89 302
TFP102UL12	11.81 x 12.99 x 5.25 300 x 330 x 133	Composite Grille UL 508 Type 12	TEP10UL12	10	0.55 14	11.16 283	2.14 54	6.88 175	11.89 302

An intake grille and filter are included with each Cooling Fan Package. Order at least one Exhaust Package separately for each installation. Order optional Exhaust Grilles as a separate accessory.

Fan and Exhaust Grille

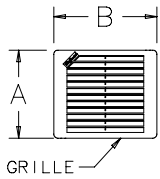

4" Fan (Fan Mounted to Back of Plenum)

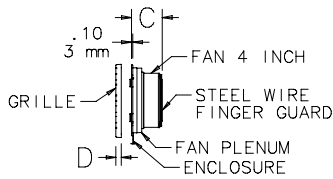

6" and 10" Fan (Box Style Plenum)

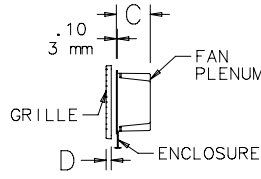

Fan and Exhaust Package Mounting Cutout

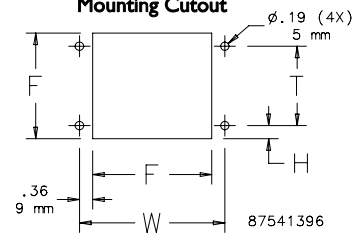

Cooling Fan and Exhaust Packages and Accessories

Technical Performance Data for Cooling Fan Packages

Composite Grille	Stainless Grille	Type 1 CFM @ 50/60 Hz	Composite Grille	Type 12 CFM 50/60 Hz	Watts @ 50/60 Hz	Voltage	Amps @ 50/60 Hz	Max. Operating Temperature (°F)	Max. Operating Temperature (°C)	Noise SIL (dB) @ 50/60 Hz	Weight (lb.)	Weight (kg)
UL Type 1	UL Type 1		UL Type 12									
TFP424	—	55	—	—	8.4	24 VDC	.35	158	70	65	4.2	1.90
TFP41	TFP41SS	46/55	TFP41UL12	21/25	17/15	115 VAC	.26/.21	158	70	37/41	4.2	1.90
TFP42	TFP42SS	46/55	TFP42UL12	21/25	16/14	230 VAC	.14/.11	158	70	37/41	4.3	1.95
TFP624	—	140	—	—	21.1	24 VDC	.88	158	70	62.5	5.3	2.40
TFP61	TFP61SS	117/140	TFP61UL12	50/60	36/32	115 VAC	.45/.36	158	70	50/56	5.3	2.40
TFP62	TFP62SS	117/140	TFP62UL12	50/60	39/35	230 VAC	.23/.18	158	70	50/56	5.4	2.45
TFP101	TFP101SS	180/215	TFP101UL12	63/75	64/80	115 VAC	.58/.70	167	75	54/61	12.0	2.45
TFP102	TFP102SS	180/215	TFP102UL12	63/75	64/80	230 VAC	.29/.35	167	75	54/61	11.4	5.17

CFM with single exhaust grille installed.

Performance Curve for a 4" Cooling Fan Package @ 60 Hz

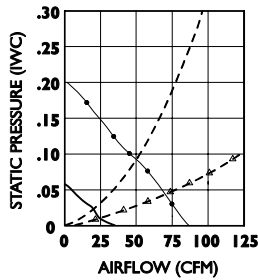

- 4 in. Cooling Fan Package
- - -■- - 4 in. Exhaust Package
- - -▲- - Two 4 in. Exhaust Packages
- ◆— 4 in. Type 12 Cooling Fan Package

Performance Curve for a 6" Cooling Fan Package @ 60 Hz

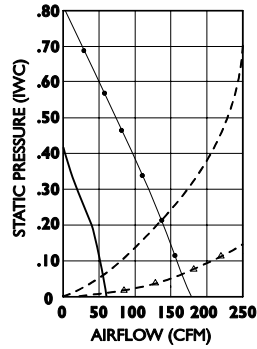

- 6 in. Cooling Fan Package
- - -■- - 6 in. Exhaust Package
- - -▲- - Two 6 in. Exhaust Packages
- ◆— 6 in. Type 12 Cooling Fan Package

Performance Curve for a 10" Cooling Fan Package @ 60 Hz

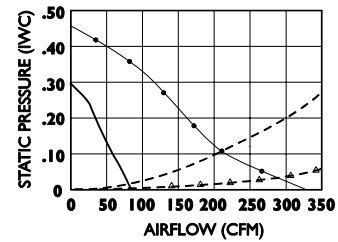

- 10 in. Cooling Fan Package
- - -■- - 10 in. Exhaust Package
- - -▲- - Two 10 in. Exhaust Packages
- ◆— 10 in. Type 12 Cooling Fan Package

Cooling Fan and Exhaust Packages and Accessories

Exhaust Grilles

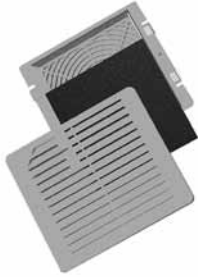

Bulletin: D85

Catalog Number	Nominal Fan Size
TEP4	4 in.
TEP4SS	4 in.
TEP4UL12	4 in.
TEP6	6 in.
TEP6SS	6 in.
TEP6UL12	6 in.
TEP10	10 in.
TEP10SS	10 in.
TEP10UL12	10 in.

Optional Grilles and Replacement Filters

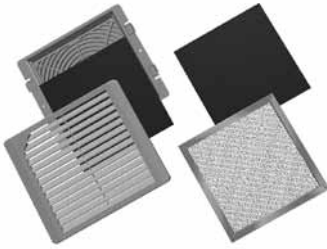

Optional grilles offer the choice of stainless steel or black ABS plastic. These grilles replace the standard RAL 7035 gray composite or stainless steel grilles on both fan and exhaust packages. Standard replacement filters are washable foam (Type 1) or disposable (Type 12). To maintain UL Type 12 rating on the enclosure, UL Type 12 filters must be used on the fan package inlet. Washable aluminum filters are also available. Aluminum filters are compatible with Type 1 systems only.

Type 12 air filters are not washable.

Bulletin: D85

Catalog Number	Description	Fits Fan and Exhaust Nominal Size	Fits Fan and Exhaust Grill Size (in.)	Fits Fan and Exhaust Grill Size (mm)
TG4SS	Brushed stainless steel grille	4	6.29 x 7.31 x .81	(160 x 186 x 21)
TG4B	Black ABS plastic grille	4	6.29 x 7.37 x .81	(160 x 187 x 21)
AFLTR4	Type 1 filter replacement (5/package)	4	—	—
AFLTR4AL	Aluminum filter replacement (5/package)	4	—	—
TFLT4UL12	Type 12 filter replacement (5/package)	4	—	—
TG6SS	Brushed stainless steel grille	6	7.80 x 8.81 x .75	(198 x 224 x 19)
TG6B	Black ABS plastic grille	6	7.80 x 8.87 x .49	(198 x 225 x 12)
AFLTR6	Foam filter replacement (5/package)	6	—	—
AFLTR6AL	Aluminum filter replacement (5/package)	6	—	—
TFLT6UL12	UL 12 filter replacement (5/package)	6	—	—
TG10SS	Brushed stainless steel grille	10	11.81 x 12.92 x .75	(300 x 328 x 19)
TG10B	Black ABS plastic grille	10	11.81 x 12.99 x .75	(300 x 330 x 19)
AFLTR10	Foam filter replacement (5/package)	10	—	—
AFLTR10AL	Aluminum filter replacement (5/package)	10	—	—
TFLT10UL12	UL 12 filter replacement (5/package)a	10	—	—

Replacement filter for Type 12 fan package only (models TFF___UL12). For Type 12 exhaust package use replacement filter AFLTRX. Filters fit all fan and exhaust packages according to their size.

EMC Fan/Grille Upgrade Kit

With the addition of this kit, the cooling fan and exhaust packages are upgraded to provide EMC (electromagnetic compatibility) protection. Consult Hoffman for shielding effectiveness (dB attenuation vs. frequency).

Separate kits must be installed on both the inlet and outlet. Cooling fan and exhaust package must be ordered separately. EMC upgrade kit will not work with stainless steel grille option.

Bulletin: D85

Catalog Number	Fits Cooling Fan Package	Fits Exhaust Grill
T4EMC	TFP41/TFP42	TEP4
T6EMC	TFP61/TFP62	TEP6
T10EMC	TFP101/TFP102	TEP10

