

- Etched polypropylene face
- Face anchored in concrete
- Ultra-violet inhibitor
- Exceeds ASTM-D1693 Standards for Environmental Stress Cracking Resistance
- Meets Caltrans #5 State Specifications

REINFORCED CONCRETE LID

No. B30D

44 lbs.

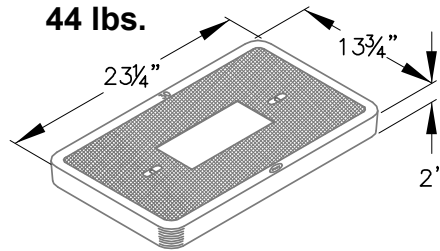

ELECTRICAL BOX

No. N30BOX

138 lbs.

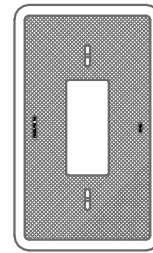
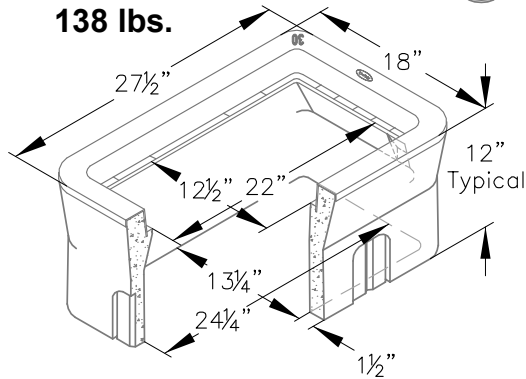

FL30D

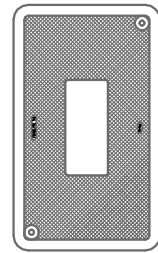

FL30T

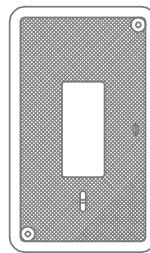

N30T

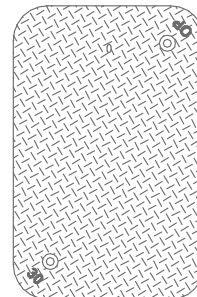

N30-61J

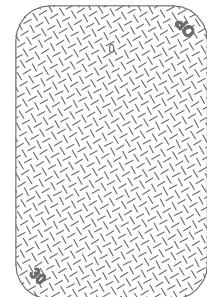

B30-61D

A high density reinforced concrete pull and junction box with end and side knockouts. Non-settling shoulders maintain grade and facilitate back filling. Approximate dimensions and weight shown.

| Ordering Code | Item | Approx. Shipping Weight | Description |
|---------------|-----------|-------------------------|--|
| N30BOX | BOX | 138 | N30 Electrical Box (13 3/4" x 24 1/4")- Meets #5 State Specifications- 16 per pallet |
| B30D | LID | 44 | Reinforced concrete |
| FL30D | LID | 20 | Fibrelyte lid, non-concrete |
| N30T | LID | 44 | Reinforced concrete, bolt down (order N99 bolts separately) |
| FL30T | LID | 20 | Fibrelyte lid, bolt down (order N99 bolts separately) |
| B30-61D | COVER | 38 | Steel checker plate |
| N30-61J | COVER | 38 | Steel checker plate, bolt down (order N99 bolts separately) |
| B30X12 | EXTENSION | 126 | 12" Reinforced concrete - 16 per pallet |
| B30SL | SLAB | 52 | Reinforced concrete (16" x 28") |

Galvanizing available on all steel covers

Oldcastle Precast®
Enclosure Solutions
MADERA/TRACY/ROSEVILLE/PHOENIX
Phone: (800) 486-7070 Fax: (800) 486-6804
Copyright © 2009 Oldcastle Precast Inc.

N30 BOX

FILE NAME: N30_ISO

ISSUE DATE: January, 2009

www.oldcastleprecast.com

N30 ELECTRICAL BOX
13-1/4" x 24-1/4"