

47690-6C

Voice, Data and Video Distribution

Brand Features

Use 4-, 6- and 8-way 1GHz Passive Video Splitters and Passive Video Splitter Modules to split digital cable, quality cable TV and off-air signals to 4, 6 or 8 televisions throughout a home or office. The Video Splitter Modules are designed for easy installation in any Leviton 140, 280 or 420 Structured Media Enclosure. The Video Splitters are easily installed in Leviton MDU Enclosures or used in any application where a passive video splitter is needed. These units feature die-cast housings and printed circuit board construction.



Item Description

1x6 Passive Video Splitter Module (1 GHz)

Technical Information

Material Specifications

Color: White

Bracket Material: Steel Powder-Coated

Mechanical Specifications

Style Name: 1X6

F-Type Inputs: 1

F-Type Outputs: 6

Frequency Range: 1 GHz

AC Power Adapter: No

Performance Data

Impedance: 75 Ohm

Insertion Loss dB: 10.0 dB - 12.1 dB

Return Loss dB Forward: 6.5 dB - 23.5 dB

Isolation dB: 28.9 dB - 37.5 dB

Product Features

Type: Passive Video Splitter

Style Name: 1X6

Frequency Range: 1 GHz

Impedance: 75 Ohm

AC Power Adapter: No

Color: White

Standards and Certifications: Meets all applicable standards

Warranty: 2 Year Limited

Color:



White

UPC Code: 07847704662

Country of Origin: China

Features and Benefits

- Splits Video signals, Outputs for up to 6 televisions.
- Provide digital cable, cable tv and other video services, via coaxial cable to any room in the house.
- Die-cast housing and printed circuit board.
- Use with the Video Amplifier to increase signal quality, analog or standard cable applications only.
- Units come with mounting bracket for simple installation in Leviton's Structured Media Enclosures.
- 75 Ohm termination caps included for unused connectors.

47690-6C 6-way Coaxial Cable Distribution Module/ 47690-6C2 6-way Coaxial Cable Distribution Module (2 GHz)

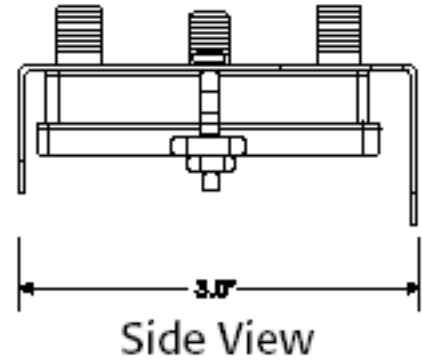
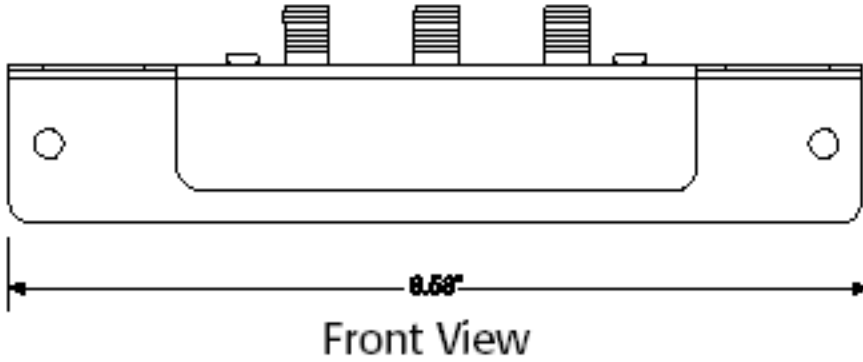

SPECIFICATION SUBMITTAL

JOB NAME: <input style="width: 95%; height: 20px;" type="text"/>	CATALOG NUMBERS: <input style="width: 95%; height: 20px;" type="text"/>	
JOB NUMBER: <input style="width: 95%; height: 20px;" type="text"/>	<input style="width: 95%; height: 20px;" type="text"/>	<input style="width: 95%; height: 20px;" type="text"/>

Leviton Manufacturing Co., Inc.
 201 North Service Road, Melville, NY 11747
 Telephone: 1-800-323-8920 · FAX: 1-800-832-9538 · Tech Line (8:30AM-7:30PM E.S.T. Monday-Friday): 1-800-824-3005

Leviton Manufacturing of Canada, Ltd.
 165 Hymus Boulevard, Pointe Claire, Quebec H9R 1E9 · Telephone: 1-800-469-7890 ·
 FAX: 1-800-824-3005 · www.leviton.com/canada

Leviton S. de R.L. de C.V.
 Lago Tana 43, Mexico DF, Mexico CP 11290 · Tel.: (+52)55-5082-1040 · FAX: (+52)5386-1797 · www.leviton.com.mx

Visit our Website at: www.leviton.com
 © 2012-2013 Leviton Manufacturing Co., Inc. All rights reserved. Subject to change without notice.

Leviton has a global presence.
 If you would like to know where your local Leviton office is located please go to: www.leviton.com/international/contacts/

