

Plugmold 2000 Series Raceway Fittings Ordering Information (continued)

Catalog No./Item	Description/Specifications
BK2010A3* G2010A3* V2010A3* WH2010A3*	Entrance End – Offers larger capacity than V2010A2. 1/2" trade size KOs on end, each side and bottom. 3/4" trade size KOs on bottom and rear. Includes ground screw. Use with 2000 Series.

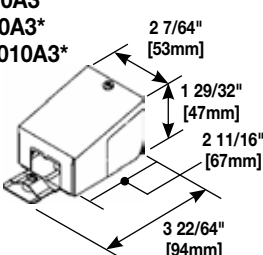

BK2010A2* G2010A2* V2010A2* WH2010A2* S2010A	Entrance End – For connecting 2000 Series Raceway with 1/2" conduit and armored cable connectors. 1/2" trade size KOs on end, each side and bottom. Includes ground screw. Use with 2000 Series Raceway.
---	---

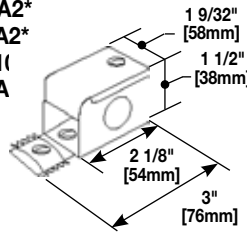

2009	Ground Clamp – For connection of equipment grounding conductor to provide additional ground to raceway. Use with 2000 Series Raceway.
-------------	--

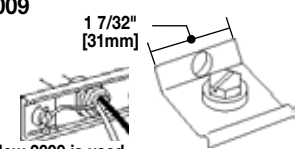

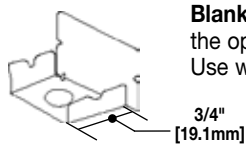

How 2009 is used.

BK2010B* G2010B* V2010B* WH2010B* S2010B*	Blank End Fitting – For closing the open end of raceway. Use with 2000 Series Raceway.
--	---

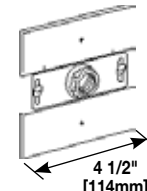

BK2051H G2051H V2051H WH2051H S2051H	Flush Plate Adapter – For feeding 2000 Series Raceway from an existing wall outlet. Equipped with 1/2" [12.7mm] threaded stud, toothed lockwasher for grounding, and conduit bushing.
---	--





Plugmold 2000 extended from wall outlet using 2051H.



2051H fastened to horizontally mounted wall box.



2051H fastened to vertically mounted wall box.

BK2011* G2011* V2011* WH2011* S2011*	90° Flat Elbow – For right angle turns on same surface. Cover stop permits neat butting of 2000C Cover. Two couplings furnished.
---	---

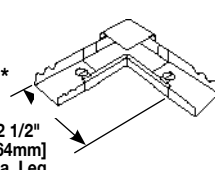

* "V" prefix indicates Ivory ScuffCoat™ finish, "G" prefix for Gray enamel finish, "BK" for Black ScuffCoat™ finish, "WH" for white enamel finish, and "S" for stainless steel finish.

2017TC	Internal Corner Coupling – Furnished with one fiber bushing.
---------------	---

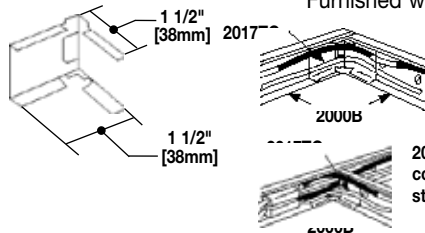

2017TC used as a corner coupling.

2017TC used as a corner coupling and a straight-through fitting.

BK2018C* G2018C* V2018C* WH2018C* S2018C*	External Elbow – To continue raceway runs around outside corner. Fills the gap when external corner is made by notching and bending the 2000B Base.
--	--

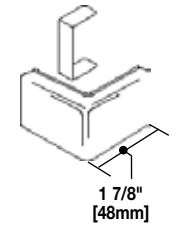

Cover gap filler snapped into place in 2018C.

BK2015* G2015* V2015* WH2015*	Tee – For branches at right angles. Couplings furnished.
--	---

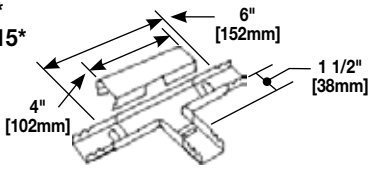

BK2048* G2048* V2048* WH2048* S2048*	Single Gang Device Box – Cover has twistouts for 2000, 500, and 700 Series Raceway. Base has 1/2" trade size KO and rectangular KO for extension to wall box. Base has #10 threaded hole for ground connection.
---	--

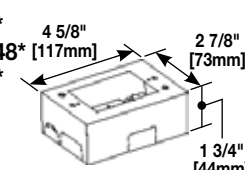

V2048-2 G2048-2	Two-Gang Device Box – Cover has G2048-2 Twistouts for 2000, 500, and 700 Series Raceway. Base has 1/2" trade size KO and rectangular KO for extension to wall box. Base has #10 threaded hole for ground connection.
----------------------------------	---

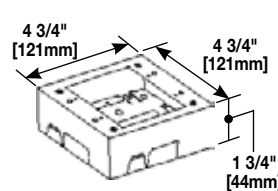

V2089	Side Reducing Connector – For connecting 2000 Series Raceway with 500 Series Raceway through side of 2000 Series Raceway.
--------------	--

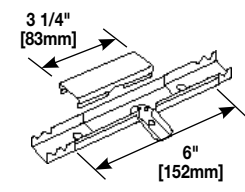

V2089F	End Reducing Connector – For connecting 2000 Series Raceway with 500 Series Raceway through end of 2000 Series Raceway.
---------------	--

