











Straight Blade Receptacles
Power Outlet Receptacles & Plugs
20, 30, 50, & 60A

Rating A. V.	Receptacle/Plug Configuration & NEMA No.						
		Flush Receptacle	Wall Plate *For 2 screw mounting **For 4 screw mounting	Surface Receptacle	Plug	Angle Plug	Connector
		Catalog Nos.					
2 Pole, 3 Wire Grounding							
30 125	5-30 	3802 § AL/CU	1-Gang: TP724* 2-Gang: SS702* 2-Gang: TP703**		D0531 .57"-1.26"		D0533 .57"-1.26"
30 125 For recreational vehicles.	NEMA TT30 	3830 AL/CU	1-Gang: TP724* 2-Gang: SS702* 2-Gang: TP703**				
30 250	6-30 	3801 AL/CU	1-Gang: TP724* 2-Gang: SS702* 2-Gang: TP703**		D0631 .57"-1.26"	3869	D0633 .57"-1.26"
50 125	5-50 				D0551 .57"-1.26"		D0553 .57"-1.26"
50 250	6-50 	3804 § AL/CU	1-Gang: TP724* 2-Gang: SS702* 2-Gang: TP703**	3852 # AL/CU	D0651 .57"-1.26"	3869	D0653 .57"-1.26"
3 Pole, 3 Wire Non-Grounding							
30 125/250 Dryer	10-30 	3860 AL/CU	1-Gang: TP724* 2-Gang: SS702* 2-Gang: TP703**	388 AL/CU	1031	3861	
50 125/250 Range	10-50 	3890 § AL/CU	1-Gang: TP724* 2-Gang: SS702* 2-Gang: TP703**	385 AL/CU	1051 .57"-1.26"	3861	1053 .32"-.91"
3 Pole, 4 Wire Grounding							
20 125/250	14-20 	3820	1-Gang: SS7*				
30 125/250 Dryer	14-30 	3864 AL/CU 3864NA †	2-Gang: SS702* 2-Gang: TP703**	3884 #/ 388440 † AL/CU 3884NA †	1431 .57"-1.26"	5746AN 3867	
30 3ø, 250	15-30 	5740 AL/CU	2-Gang: SS702* 2-Gang: TP703**			5741AN	
50 125/250 Range	14-50 	3894 § AL/CU 3894NA †	2-Gang: SS702* 2-Gang: TP703**	3854 #/ 385440 † AL/CU 3854NA †	1451 .57"-1.26"	5745AN 3867	
50 3ø, 250	15-50 	5750 AL/CU	2-Gang: SS702* 2-Gang: TP703**			5751AN	
60 3ø, 250	15-60 	5760 AL/CU	2-Gang: SS702* 2-Gang: TP703**			5761AN	
4 Pole, 4 Wire Non-Grounding							
20 3øY, 120/208	18-20 	3822	1-Gang: SS7*		7251DF .35"-1.05"		
60 3øY, 120/208	18-60 	3870 § AL/CU	2-Gang: SS701**		D1861 .57"-1.26"	8302AN	

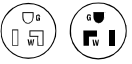
*In bulk pack of 40 with plastic snap-in wire clamp. §Up to #3 AWG aluminum conductors. #Up to #4 AWG aluminum conductors.
For further information consult Wall Plate Section Q (for Stainless Steel versions of TP724 and TP703, refer to Pages Q-13 and Q-14).
†NAFTA-Compliant Receptacles are ideal for use on projects subject to the provisions of the Buy American Act.

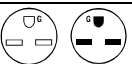
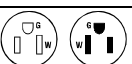
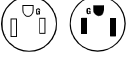
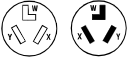
All devices listed on this page conform to NEMA WD-1 and WD-6.

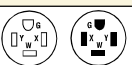
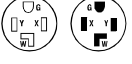
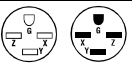
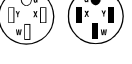
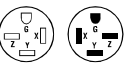
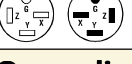
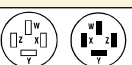
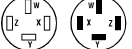
Straight Blade Receptacles Power Outlet Receptacles & Plugs

20, 30, 50, & 60A



Straight Blade Receptacles

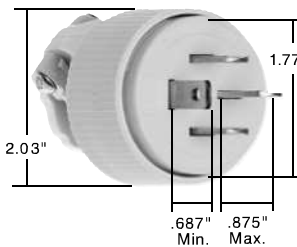
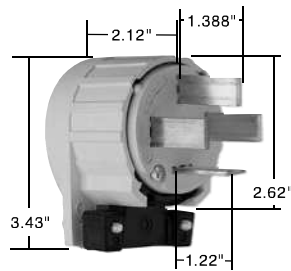
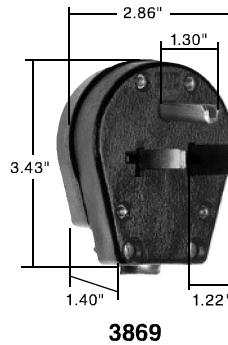
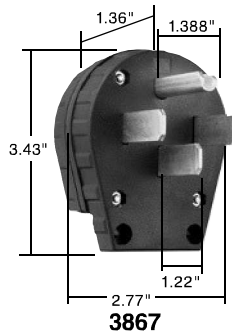
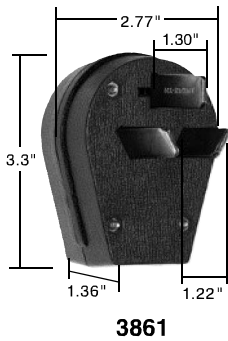
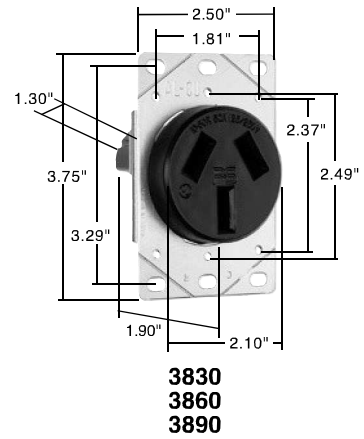
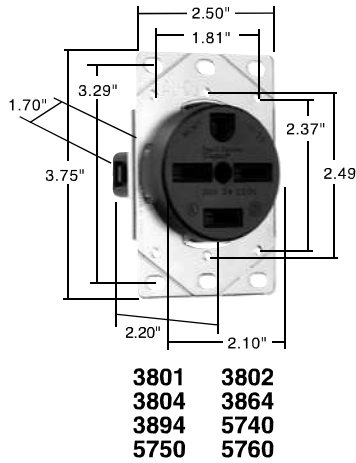
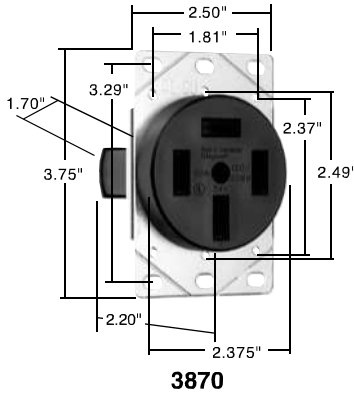
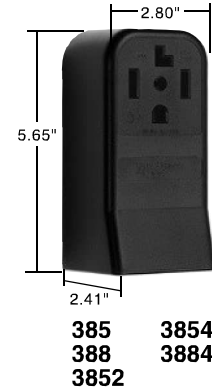
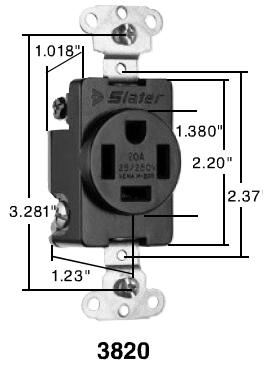
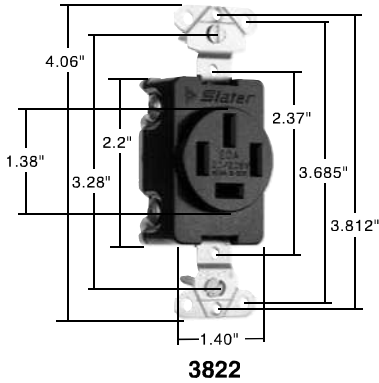

All devices listed on this page conform to NEMA WD-1 and WD-6.

Power Outlet Receptacles & Plugs