











Straight Blade Receptacles
Power Outlet Receptacles & Plugs
20, 30, 50, & 60A

Rating A. V.	Receptacle/Plug Configuration & NEMA No.							
		Flush Receptacle	Wall Plate *For 2 screw mounting **For 4 screw mounting	Surface Receptacle	Plug	Angle Plug	Connector	
		Catalog Nos.						
2 Pole, 3 Wire Grounding								
30 125	5-30 	3802 § AL/CU	1-Gang: TP724* 2-Gang: SS702* 2-Gang: TP703**		D0531 .57"-1.26"		D0533 .57"-1.26"	
30 125 For recreational vehicles.	NEMA TT30 	3830 AL/CU	1-Gang: TP724* 2-Gang: SS702* 2-Gang: TP703**					
30 250	6-30 	3801 AL/CU	1-Gang: TP724* 2-Gang: SS702* 2-Gang: TP703**		D0631 .57"-1.26"	3869	D0633 .57"-1.26"	
50 125	5-50 				D0551 .57"-1.26"		D0553 .57"-1.26"	
50 250	6-50 	3804 § AL/CU	1-Gang: TP724* 2-Gang: SS702* 2-Gang: TP703**	3852 # AL/CU	D0651 .57"-1.26"	3869	D0653 .57"-1.26"	
3 Pole, 3 Wire Non-Grounding								
30 125/250 Dryer	10-30 	3860 AL/CU	1-Gang: TP724* 2-Gang: SS702* 2-Gang: TP703**	388 AL/CU	1031	3861		
50 125/250 Range	10-50 	3890 § AL/CU	1-Gang: TP724* 2-Gang: SS702* 2-Gang: TP703**	385 AL/CU	1051 .57"-1.26"	3861	1053 .32"-.91"	
3 Pole, 4 Wire Grounding								
20 125/250	14-20 	3820	1-Gang: SS7*					
30 125/250 Dryer	14-30 	3864 AL/CU 3864NA †	2-Gang: SS702* 2-Gang: TP703**	3884 #/ 388440 † AL/CU 3884NA †	1431 .57"-1.26"	5746AN 3867		
30 3ø, 250	15-30 	5740 AL/CU	2-Gang: SS702* 2-Gang: TP703**			5741AN		
50 125/250 Range	14-50 	3894 § AL/CU 3894NA †	2-Gang: SS702* 2-Gang: TP703**	3854 #/ 385440 † AL/CU 3854NA †	1451 .57"-1.26"	5745AN 3867		
50 3ø, 250	15-50 	5750 AL/CU	2-Gang: SS702* 2-Gang: TP703**			5751AN		
60 3ø, 250	15-60 	5760 AL/CU	2-Gang: SS702* 2-Gang: TP703**			5761AN		
4 Pole, 4 Wire Non-Grounding								
20 3øY, 120/208	18-20 	3822	1-Gang: SS7*		7251DF .35"-1.05"			
60 3øY, 120/208	18-60 	3870 § AL/CU	2-Gang: SS701**		D1861 .57"-1.26"	8302AN		

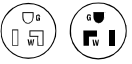
*In bulk pack of 40 with plastic snap-in wire clamp. §Up to #3 AWG aluminum conductors. #Up to #4 AWG aluminum conductors.
For further information consult Wall Plate Section Q (for Stainless Steel versions of TP724 and TP703, refer to Pages Q-13 and Q-14).
†NAFTA-Compliant Receptacles are ideal for use on projects subject to the provisions of the Buy American Act.

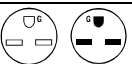
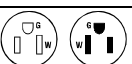
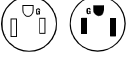
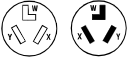
All devices listed on this page conform to NEMA WD-1 and WD-6.

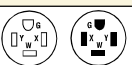
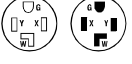
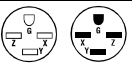
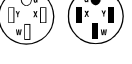
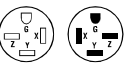
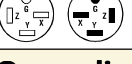
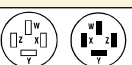
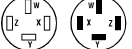
Straight Blade Receptacles Power Outlet Receptacles & Plugs

20, 30, 50, & 60A



Straight Blade Receptacles

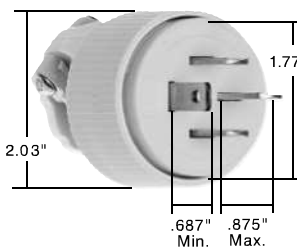
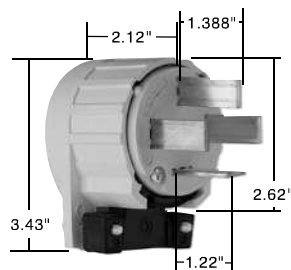
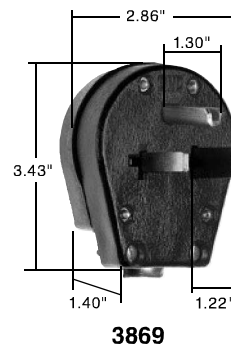
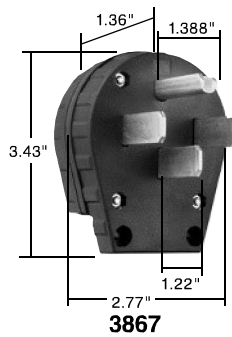
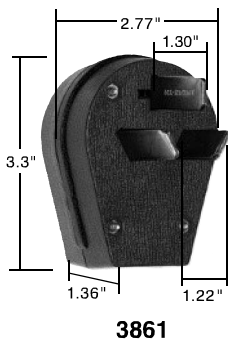
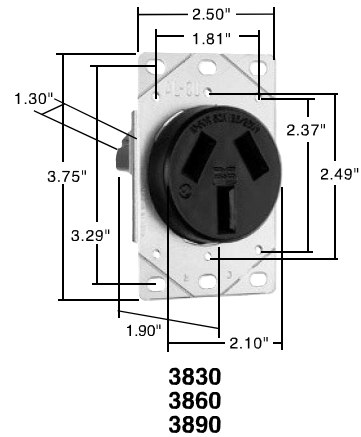
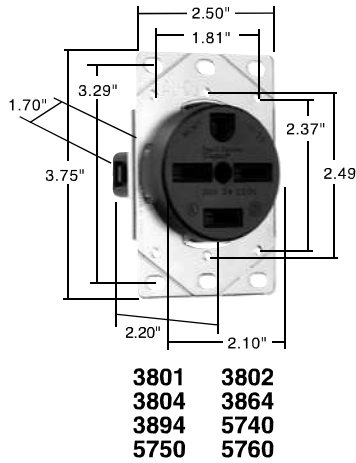
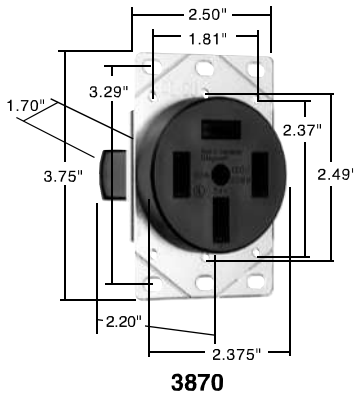
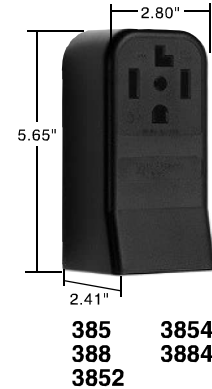
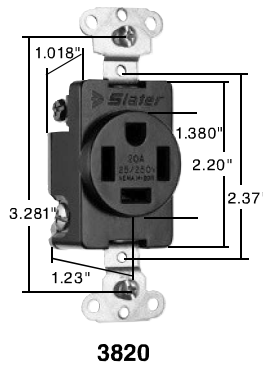
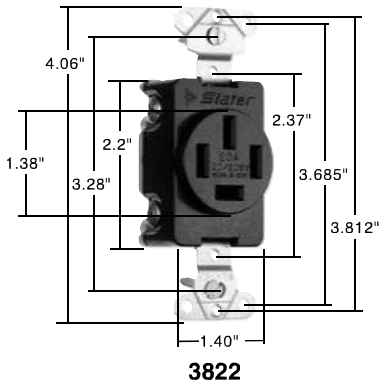

All devices listed on this page conform to NEMA WD-1 and WD-6.

Power Outlet Receptacles & Plugs

Straight Blade Receptacles Power Outlet Receptacles & Plugs

20, 30, 50 & 60A



Flush Receptacle



Surface Receptacle



Angle Plug



Plug



Wall Plate

Application



Power devices are for use in industrial, institutional, commercial, and certain residential applications to provide higher amperage power to equipment such as air conditioners, copiers, small welders, ranges, and dryers.

Features

- Flush receptacle bodies are molded of arc-resistant plastic.
- All devices are of dead front design.
- Receptacles have double-wipe contacts of high performance copper-based alloy.
- Recommended stainless steel wall plates are listed with each flush receptacle.
- UL Listed for use with aluminum wiring.

Receptacle Amp. Rating	AWG Size	Material
Conductor Size & Material for Power Outlet Receptacles		
20A	#14 – #10	Copper/Copper-clad
30A	#10 – #6	Copper/Copper-clad/Aluminum
50A	#10 – #6	Copper/Copper-clad/Aluminum
60A	#8 – #4	Copper/Copper-clad/Aluminum

Ampere Rating	With Non-Metallic Sheathed Cable	With Conduit
Recommended Box Sizes for Flush Receptacles		
30A	4" sq. x 2-1/8" deep	4-11/16" sq. x 2-1/8" deep
50A	4-11/16" sq. x 2-1/8" deep	2-g deep box (4" sq. x 2-1/2" deep)
60A	4-11/16" sq. x 2-1/8" deep with 1/2" raised ring	2-g deep box (4" sq. x 2-1/2" deep)

Description	Color	Nylon	Metal	Wall Plates Recommended for the Following Flush Receptacles
		TradeMaster®	Material	
Accessories – Flush Receptacle Wall Plates				
 <ul style="list-style-type: none"> • 2.156" hole for 2.125" dia. device • 2 mtg. holes 	Ivory White Brown Gray Black Light Almond	TP724I TP724W TP724 TP724GRY TP724BK	Chrome S384C	2 Pole, 3 Wire Grounded 3801 3804 3802 3830
		TP724LA		
 <ul style="list-style-type: none"> • 2-5/32" hole for 2-1/8" dia. device • 2 mtg. holes 			302S/S SS702	3 Pole, 3 Wire Ungrounded 3860 3860
 <ul style="list-style-type: none"> • 2.1563" hole for 2.125" dia. device • 4 mtg. holes 	Ivory White Brown Gray Black Light Almond	TP703I TP703W TP703 TP703GRY TP703BK	Chrome S3862C 302S/S SS703	3 Pole, 4 Wire Ungrounded 3864 5740 3894 5750 5760
		TP703LA		

New Installations require 4 wire range and dryer outlets. Ref: 2002 NEC 250-134, 250-138
Existing Installations permitted to use 3 wire range and dryer outlets. Ref: 2002 NEC 250-140