

FAS L BRACKET

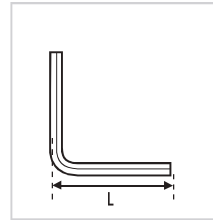
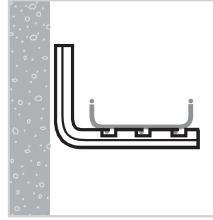
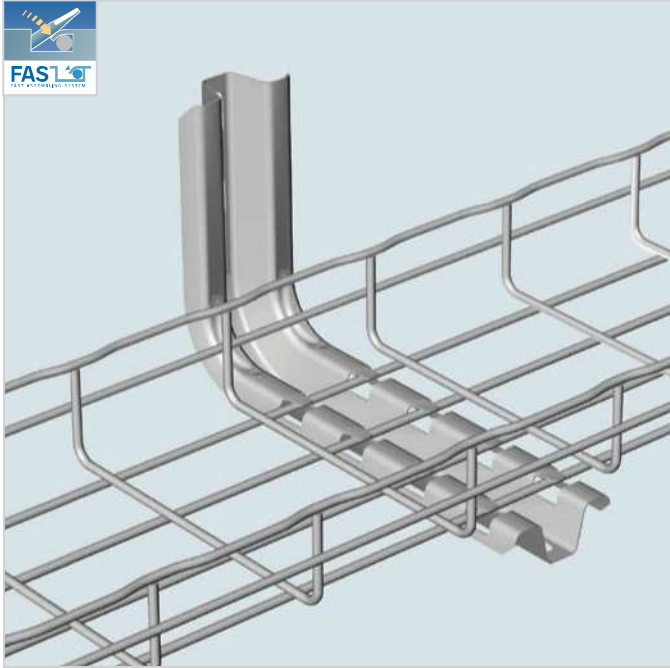

- For installation of Cablofil tray onto walls.
- Reduce installation time—patented FAS style attachment holds cable tray secure without nuts and bolts.
- Order “width” to match tray.

WALL MOUNTINGS

	TRAY WIDTH		LENGTH (L)		WEIGHT		PG	GC	304L	316L	BL	PE
	INCHES	MM	INCHES	MM	LBS	KG						
FASL 100	4"	100	7"	178.5	0.9	0.4	556 100	556 103	*	556 104	941 257	930 523
FASL 150	6"	150	9"	228.5	1.0	0.5	556 110	556 113	*	556 114	941 258	930 525
FASL 200	8"	200	11"	278.5	1.1	0.5	556 120	556 123	*	556 124	941 259	930 527
FASL 300	12"	300	14.9"	378.5	1.4	0.6	556 130	556 133	*	556 134	941 260	930 529
FASL 400	16"	400	18.8"	478.5	1.8	0.8	556 140	556 143	556 143	*	*	*
FASL 450	18"	450	20.8"	528.5	2.1	1.0	556 150	556 153	*	556 154	942 848	942 600

*Product number was not available at time of print.

WTSB WALL TOP SADDLE BRACKET

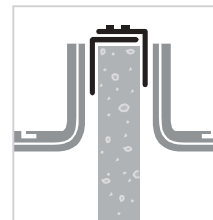
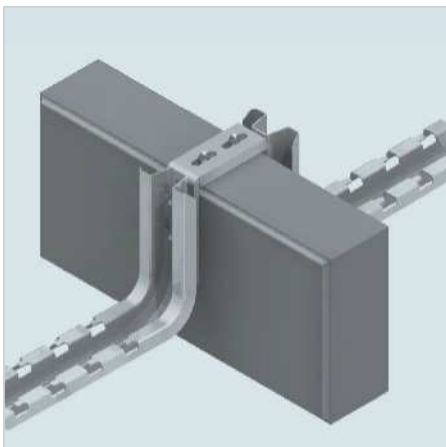

- Installs Cablofil tray onto interior block walls without drilling or concrete anchors.
- Includes two EZBN 5/16 bolts to attach FAS L or FAS C tray supports (not included).

	PKG QTY	WIDTH		WEIGHT		EZ
		INCHES	MM	LBS	KG	
WTSB 46	10	4-6	102-152	1.9	0.86	943 347
WTSB 810	10	8-10	203-254	2.3	1.05	943 348

Patent Number – 20090289152

FAS C BRACKET

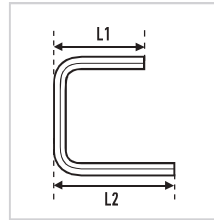
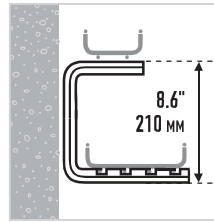

- Use one or more FAS C brackets to create multiple level tray installations.
- Saves installation time – patented FAS style attachment holds cable tray secure without nuts and bolts.
- EZ BN 1/4 and CE 25 are sold separately.

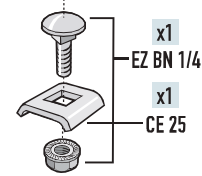

	TRAY WIDTH		LENGTH (L1)		LENGTH (L2)		WEIGHT		PG	GC	304L	316L	BL	PE
	INCHES	MM	INCHES	MM	INCHES	MM	LBS	KG						
FASC 100	4"	100	6.7"	170	7"	178.5	1.4	0.6	556 300	556 303	*	556 304	941 261	930 531
FASC 150	6"	150	6.7"	170	8.9"	228.5	1.5	0.7	556 310	556 313	*	556 314	941 262	930 533
FASC 200	8"	200	6.7"	170	10.9"	278.5	1.7	0.8	556 320	556 323	*	556 324	941 263	930 535
FASC 300	12"	300	11.3"	288	14.9"	378.5	1.9	0.9	556 330	556 333	*	556 334	941 264	930 537
FASC 400	16"	400	11.3"	288	18.8"	478.5	2.4	1.1	556 340	556 343	556 344	*	943 096	*
FASC 450	18"	450	11.3"	288	20.8"	528.5	2.75	1.25	556 350	556 353	556 354	*	942 596	*

*Product number was not available at time of print.

