

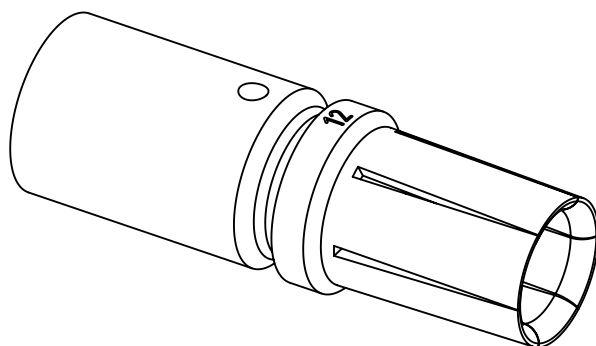

assembly notes see catalog
 crimp zone acc. to DIN EN 46235 indicator 12
 for stranded fine wire acc. to VDE 0295 class 5/ IEC 60228 class 5
 wire gauge: 35mm²
 stripping length: 16mm

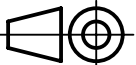

 All Dimensions in mm Original Size DIN A4	Scale	Free size tol.		Ref.	
	2:1			Sub.	
 All rights reserved Department EL PD - DE	Created by	Inspected by	Standardisation	Date	State
	HARLASSK	GERB	TIEMANNA	2015-03-25	Final Release
HARTING Electric GmbH & Co. KG D-32339 Espelkamp	Title			Doc-Key / ECM-Nr.	
	Han TC100 female contact 35mm ²			100150730/UGD/004/C 500000086245	
Type	Number	Rev.		Page	
TB	09 11 000 6235	C		1/1	