

# CLASS J 600 Volt Fuse Blocks

## Mersen Class J fuse blocks accommodate all Class J fuses.















A choice of screw, pressure plate, box and special order stud connectors fit a wide range of stranded or solid copper or aluminum conductors. Insulators are either molded glass-filled polycarbonate (GFPC) or phenolic with verified dielectric strength in excess of 2500V. 30A, 60A and the new 100A SJ fuse blocks feature a unique adder block configuration which can be snapped onto 1-, 2-, or 3-pole blocks to form multi-pole segmented blocks of as many poles as desired. All fuse clips are made of high conductivity tin-plated copper, with a choice of spring-reinforced or non-spring reinforced clips. Space saving options are now available in the 30A and 100A configurations which are noted in the product selection tables.



## Recommended Fuse Usage:

- Class J Blocks (600V) use with AJT, A4J, HSJ

## Clip & Connector Types:

30A & 60A Clips	Connectors	Connectors	Connectors	Connectors
Spring Reinforced 	Non-spring Reinforced 30A & 60A Box 	Spring Reinforced 30A & 60A Box 	Spring Reinforced 100A Box 	Spring Reinforced 400A Box Side Clip 
Non-spring Reinforced 	Non-spring Reinforced 30A Screw 	Spring Reinforced 30A Screw 	Spring Reinforced 100A Box Side Clip 	Spring Reinforced 400A Box In-line Clip 
	Non-spring Reinforced 30A Pressure Plate 	Spring Reinforced 30A Pressure Plate 	Spring Reinforced 200A Box Side Clip 	Spring Reinforced 600A Box In-line Clip 

## Ratings:

**Volts** : 600VAC / DC

**Amps** : 30A, 60A, 100A,  
: 200A, 400A, 600A

**SCCR** : 200kA

## Approvals:

- All class J fuse blocks meet the requirements of UL4248 (formerly UL512)
- UL listed Guide IZLT, File E52283
- CSA certified class 6225, File 32169



# CLASS J 600 Volt Fuse Blocks

## 600 Volt, 30 & 60 Ampere Class J Fuse Blocks

Ampere Rating	Poles	Connectors		Catalog Number		Connector Torque In - lb
		Types	Wire Range	Non-Spring Reinforced	Spring Reinforced	
30 GFPC Insulator	ADDER	BOX	Al/Cu #2-14	60300J	60305SJ	35
	1			60301J	60306SJ	
	2			60302J	60307SJ	
	3	60303J	60308SJ			
	ADDER	SCREW	Cu* #4-14	60310J	60315SJ	20
	1			60311J	60316SJ	
	2			60312J	60317SJ	
	3	60313J	60318SJ			
	ADDER	PRESSURE PLATE	Cu* #4-14	60320J	60325SJ	20
	1			60321J	60326SJ	
	2			60322J	60327SJ	
	3	60323J	60328SJ			
	ADDER	BOX	Cu* #4-14	-	60355SJ	35
	1			-	60356SJ	
	2			-	60357SJ	
3	-	60358SJ				
60 GFPC Insulator	ADDER	BOX	Al/Cu #2-14	60600J	60605J	45
	1			60601J	60606J	
	2			60602J	60607J	
	3	60603J	60608J			
	ADDER	BOX	Cu* #4-14	-	60655J	45
	1			-	60656J	
2	-			60657J		
3	-	60658J				

**Note:** To convert 30A "SJ" adder pole to single pole use end barrier cat # U09372. To convert 30A or 60A standard J adder pole to single use pole use end barrier cat # U09617. Recommended mounting screws for all 30A and 60A fuse blocks: 1/4" (0.250" dia).

\*Fuses have copper box connectors and clips and are for copper wires only. These are specifically designed with the same coefficient of expansion as copper wire for improved heat cycling and meet or exceed OEM "no aluminum" specifications.

### Dimensions for 30A Space Saving "SJ" Style Fuse Blocks

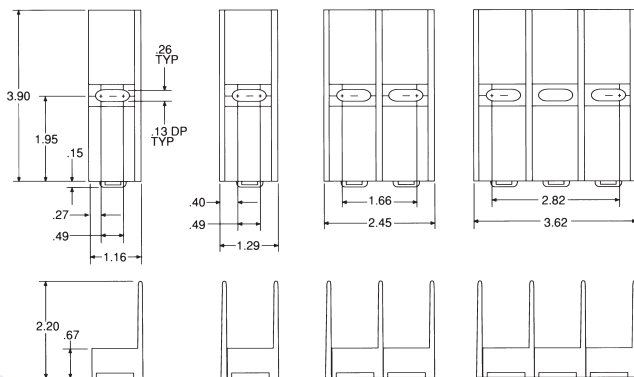

Adder 1-Pole 2-Pole 3-Pole

### Dimensions for 30A and 60A Standard Class J Style Fuse Blocks

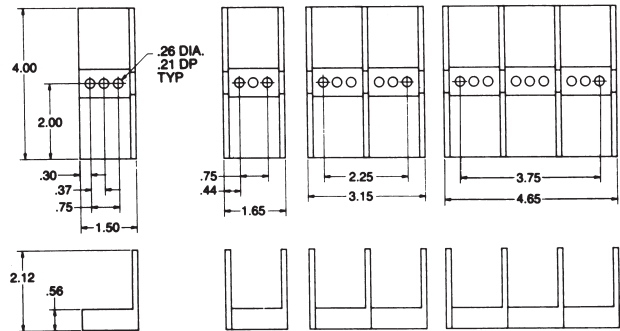

Adder 1-Pole 2-Pole 3-Pole