

createchange

FEATURES

- Attractive architectural center lens
- High efficiency acrylic center lens features linear prisms for high performance without pixelation
- Appropriate for offices, schools, medical, and public spaces
- High performance reflector with matte white paint standard
- 60,000 hour LEDs at L80 (up to 150,000 projected life) for reduced maintenance
- Four LED color choices and 80 CRI
- Six lumen packages
- Multiple driver options to satisfy different applications
- LED modules and electrical accessible from below
- Optional architecturally styled integration of daylight and occupancy sensor(s)
- QR code traceability
- Integral battery pack optional on most models
- Compatible with Dual-Lite inverters
- Recessed, surface or cable mount
- Air return option
- DesignLights Consortium® (DLC) qualified
- Five year warranty (Terms and Conditions apply)

PROJECT INFORMATION

Project Name _____

Type _____

Catalog No. _____

Date _____

CONSTRUCTION

Luminaire housing, reflectors and end caps are die formed code gauge cold rolled steel. High transmission extruded acrylic enclosed lens features linear prisms with custom frost for high efficacy without pixelation.

SHIELDING

Removable lens for easy access to LED module and electrical components.

FINISH

All reflective surfaces are finished after fabrication with unique formula high reflectivity matte white paint for soft, uniform indirect illumination.

INSTALLATION

An access plate is furnished with each luminaire for fast wiring access without the necessity to open the fixture or wireway.

CEILING COMPATIBILITY

Luminaire fits recessed exposed Grid ceilings (G); four integral NEC compliant T-bar clips are standard. Can be placed in Slot Grid (SG) style ceiling with regress 3/8" above ceiling plane. A Flange Kit (FK) accessory is available for recessed hard ceiling applications. Surface Mount (SM) option allows placement below ceiling plane. Cable Mount (CM) option allows product suspension below ceiling plane.

CERTIFICATION

All luminaires are built to UL1598 and 2108 standards, and bear appropriate CSA labels. Damp location label standard. Emergency-equipped fixtures labeled UL 924 and Dry Location unless specified. Adheres to LM79, LM80, and TM21 industry standards. DesignLights Consortium® (DLC) qualified. Please refer to the DLC website for specific product qualifications at www.designlights.org.

IC RATING

IC label is standard for recessed products. Note that IC label is void if product is installed on site with a combination of both step-dimming (ESD) driver plus through wiring or for air return fixtures.

WARRANTY

Five year warranty (Terms and Conditions apply).

ORDERING INFORMATION

EXAMPLE LCAT22-35HLG-ESDU

LCAT		22	-	-	-	U	-	
MODEL	COLOR TEMPERATURE	SIZE	LUMEN OUTPUT	CEILING TYPE	AIR FUNCTION	VOLTAGE	OPTIONS	
LCAT LED Contemporary Architectural Troffer	30 3000K 35 3500K 40 4000K 50 5000K	22 2' x 2'	VW Very Low Watt MW Medium Watt LW Low Watt ML Medium Lumen HL High Lumen VL Very High Lumen	G Grid Lay-in ¹ SM Surface Mount ² CM Cable Suspended Mount ^{2,3}	Blank Static A Air Return Side Slots	U 120V-277V 347 347V	ELL14 Emergency Battery Pack Installed, 1400 Lumens ^{4,5} C388 3-Wire Flex C488 4-Wire Flex C588 5-Wire Flex GLR Fast Blow Fuse NYC NYC Compliant EOR End of Row (SM and CM only. Provides end wiring access for continuous row mounting.) ² INT Intermediate (SM and CM only. Provides ends with wiring access for continuous row mounting.) ² CP Chicago Plenum ODP Occupancy and Daylight Sensors, Philips ^{4,6}	
DRIVER								
E Fixed Output ESD Step Dimming ⁴ ED 0-10V Dimming ED1 0-10V 1% Dimming ⁵ LUTH Lutron H Series 1% Dimming ^{4,5} LUT5 Lutron 5 Series 5% Dimming ^{4,5}								
PRODUCT AVAILABILITY								
SIZE	LUMEN PACKAGE	NOMINAL LUMENS	NOMINAL WATTS	LUMENS PER WATT				
22	VW	1600-1750	16	100-109				
22	MW	2150-2300	22	100-107				
22	LW	2650-3050	25	107-123				
22	ML	3200-3400	30	107-115				
22	HL	3550-4050	35	100-115				
22	VL	4000-4600	42	96-110				
ACCESSORIES (ORDER SEPARATELY)								
FK22 2' x 2' Single Flange Kit (Shipped separately)								
CM48Y2SC3F-KIT 48" Cable Mount Kit for 2' wide Cable Mount fixtures, 3 Wire								

See Product Availability Table below.

DRIVER AVAILABILITY TABLE						
	VW	MW	LW	ML	HL	VL
E	X	X	X	X	X	X
ED	X	X	X	X	X	X
ED1	X	X	X	X	X	X
ESD			X	X	X	X
LUT5		X	X	X	X	
LUTH		X	X	X	X	

Nominal lumen range represents 3000K through 5000K. Lumens vary according to color temperatures and other factors. See specific photometric test(s).

¹ For drywall, order G with Flange Kit Accessory.
² Not available with Air Return (A) air function
³ Order hanger accessories separately.
⁴ Not available in 347V
⁵ For compatibility with Dual-Lite LiteGear® inverters, contact Hubbell Lighting Representative.
⁶ Only available with 0-10V Dimming (ED) Driver Option.
 For questions about configuration options, contact Hubbell Representative

PHOTOMETRIC DATA

Test LCAT22-35LWG-EDU 15681 Test Date 1/9/2015

LUMINAIRE DATA

Luminaire	LCAT22-35LWG-EDU LCAT Led Architectural Troffer, Recessed Architectural 2 x 2 led with frosted linear prism lens
Ballast	XI040C110V054BPT1
Ballast Factor	1.00
Lamp	LED
Fixture Lumens	2784
Watts	25.00
Mounting	Recessed
Shielding Angle	0° = 90 90° = 90
Spacing Criterion	0° = 1.20 90° = 1.33
Luminous Opening in Feet	Length: 1.92 Width: 1.92 Height: 0.00

ZONAL LUMEN SUMMARY

Zone	Lumens	% Lamp	% Fixt.
0-30	706	25.4	25.4
0-40	1158	41.6	41.6
0-60	2067	74.2	74.2
0-90	2784	100.0	100.0
0-180	2784	100.0	100.0

ENERGY DATA

Total Luminaire Efficiency	100.0%
Total Lumens per Watt	111
IESNA RP-1-2004 Compliance	Non-Compliant
Comparative Yearly Lighting Energy Cost per 1000 Lumens	\$2.16 based on 3000 hrs. and \$0.08 per KWH

INDOOR CANDELA PLOT

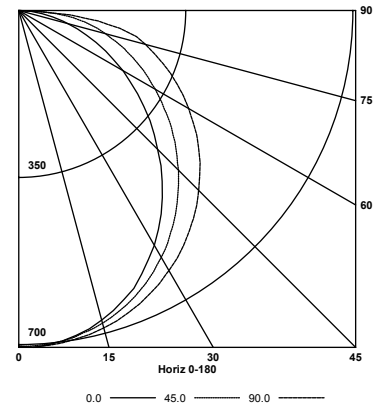

LUMINAIRE DATA

Luminaire	LCAT22-35MLG-EDU LCAT Led Architectural Troffer, Recessed Architectural 2 x 2 led with frosted linear prism lens
Ballast	D10CC55UNVTZ-C
Ballast Factor	1.00
Lamp	LED
Fixture Lumens	3261
Watts	30.20
Mounting	Recessed
Shielding Angle	0° = 90 90° = 90
Spacing Criterion	0° = 1.20 90° = 1.32
Luminous Opening in Feet	Length: 1.92 Width: 1.90 Height: 0.00

ZONAL LUMEN SUMMARY

Zone	Lumens	% Lamp	% Fixt.
0-30	825	25.3	25.3
0-40	1352	41.4	41.4
0-60	2415	74.0	74.0
0-90	3261	100.0	100.0
0-180	3261	100.0	100.0

ENERGY DATA

Total Luminaire Efficiency	100.0%
Total Lumens per Watt	108
IESNA RP-1-2004 Compliance	Non-Compliant
Comparative Yearly Lighting Energy Cost per 1000 Lumens	\$2.20 based on 3000 hrs. and \$0.08 per KWH

Test LCAT22-35MLG-EDU Test Date 1/20/2015

INDOOR CANDELA PLOT

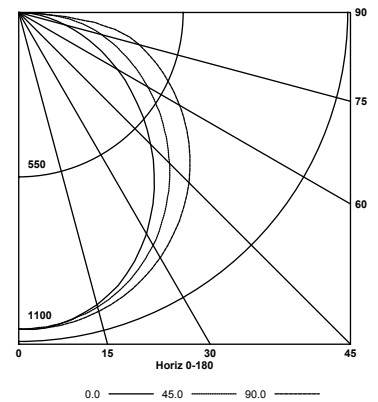

LUMINAIRE DATA

Luminaire	LCAT22-35HLG-EDU LCAT Led Architectural Troffer, Recessed Architectural 2 x 2 led with frosted linear prism lens
Ballast	D10CC55UNVTZ-C
Ballast Factor	1.00
Lamp	LED
Fixture Lumens	3685
Watts	35.40
Mounting	Recessed
Shielding Angle	0° = 90 90° = 90
Spacing Criterion	0° = 1.20 90° = 1.32
Luminous Opening in Feet	Length: 1.90 Width: 1.90 Height: 0.00

ZONAL LUMEN SUMMARY

Zone	Lumens	% Lamp	% Fixt.
0-30	934	25.3	25.3
0-40	1530	41.5	41.5
0-60	2732	74.1	74.1
0-90	3685	100.0	100.0
0-180	3685	100.0	100.0

ENERGY DATA

Total Luminaire Efficiency	100.0%
Total Lumens per Watt	104
ANSI/IESNA RP-1-2004 COMPLIANCE:	Non-Compliant
Comparative Yearly Lighting Energy Cost per 1000 Lumens	\$2.29 based on 3000 hrs. and \$0.08 per KWH

Test LCAT22-35HLG-EDU Test Date 2/13/2015

INDOOR CANDELA PLOT

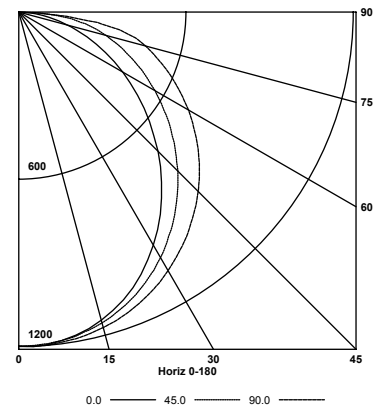

DIMENSIONAL DATA — GRID, STATIC

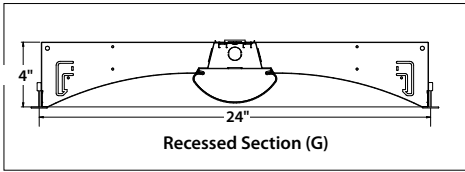

GRID, STATIC

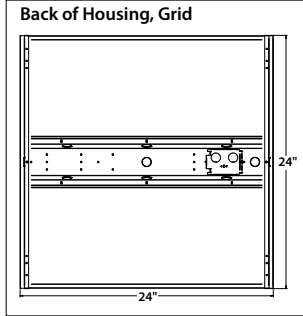
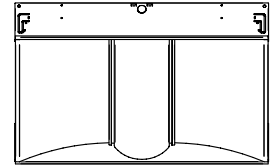
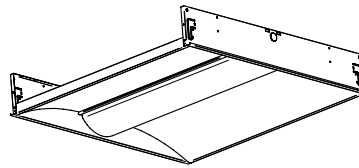

GRID, AIR RETURN

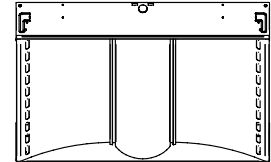
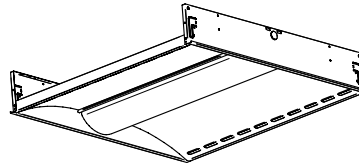

CEILING COMPATIBILITY

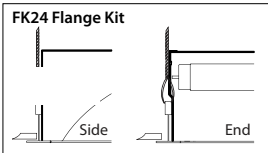
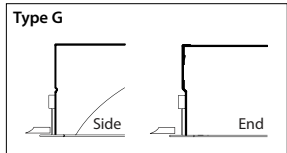

For lay-in installation in exposed grid ceilings. Maximum tee widths of 1" and maximum tee heights of 2" allowed.

For hard ceiling applications, order FK22 flange kit. Flange kit wires directly into concealed ceiling opening for a clean, finished appearance.

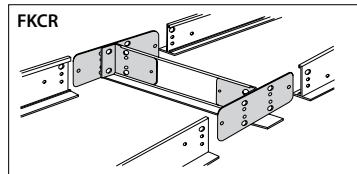

For flanged fixtures in row configurations, the FKCR adapter bracket kit is required in addition to the FK22 kit. Order one less FKCR than the total number of fixtures in row. (Example: Row of two, order (2) FK22 & (1) FKCR)

Row cut out dimensions using FK22s & FKCR adapters:
Width 24³/₈", Length [24" × (# in row)] + ³/₈".
Example: (24" × 2) + ³/₈" = 48³/₈"

Flange kit cut out dimension for single unit only: 24³/₈" × 24³/₈"

DIMENSIONAL DATA — SURFACE MOUNT & CABLE MOUNT, STATIC ONLY

Surface Section (SM)

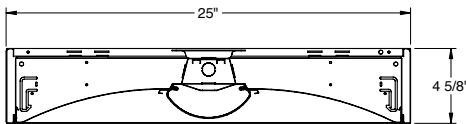

Back of Housing, Surface Mount (SM) and Cable Mount (CM)

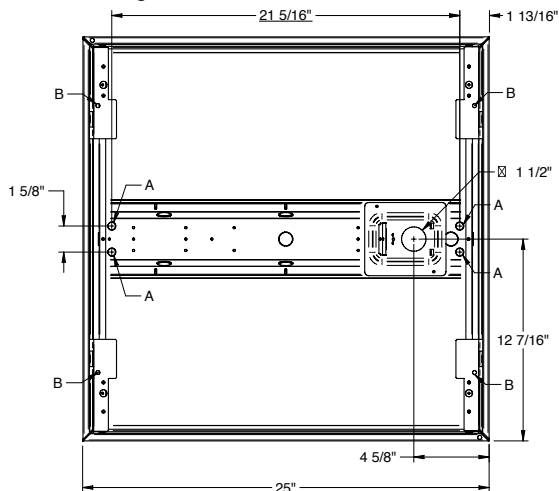

Surface Mount:

Order SM ceiling type. Mounting collar required for surface mounting. (4) Mounting knock-outs, ³/₈", provided in center channel as indicated at left, marked A.

Cable Mount:

Order CM ceiling type. Use CM48Y2SC3F-KIT 48" Cable Mount Kit for 2' wide CM fixtures. Mounting holes are provided in diagonal straps shown at left, marked B.

* For Cable Mount a 2" x 3" access plate with (4) ⁷/₈" KOs provided in place of Mounting Collar shown.

NOTE: All dimensions are in inches; dimensions and specifications are subject to change without notice. Please consult factory or check sample for verification.