

DESCRIPTION

Low voltage Euro style lampholders with integral 12V magnetic transformers. Construction is die cast metal with removable front plate for ease of relamping. Both the L1760 and L1770 lampholders accept color filters and lenses.

Catalog #	Type
Project	
Comments	
Prepared by	Date

SPECIFICATION FEATURES

A...Electrical Quick Lock Adapter

Polycarbonate casing attaches electrically and mechanically anywhere along the track. Visual polarity line assures proper grounding. Two position conductor allows use in single circuit and either circuit of two circuit track

B...Arm

Metal arm allows lampholder to rotate 338° horizontally and adjust vertically from 0° to 90° for maximum aiming adjustability.

C...Front Plate

Front plate removes and installs without tools for relamping. L1770 has partial contrasting black finish.

D...Housing

Die cast metal with integral 12V magnetic transformer and grooved cooling fins.

Labels

UL listed and CSA certified for use with Halo and Lazer-by-Halo track and track systems.

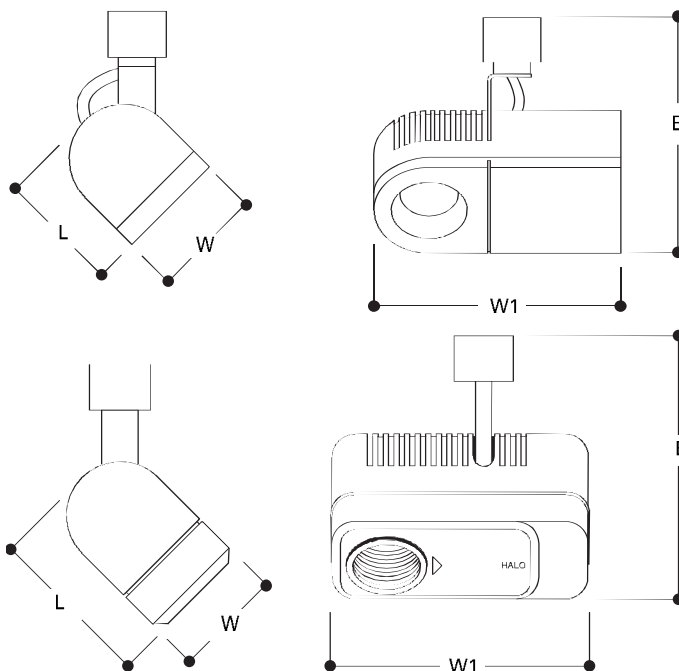

L1760



L1770

**LOW VOLTAGE
EURO STYLE
LAMP HOLDERS**

Power-Trac®

ORDERING INFORMATION

SAMPLE NUMBER: L1760P

Lampholders	Finishes	Accessories
L1760 L1770	P=Satin White MB=Matte Black	(See Below)

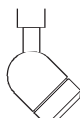
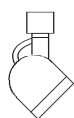

L1760

For use with: 50W 12V MR16
L = 3 1/8" [79mm]
W = 2 7/8" [73mm]
W1 = 6 1/8" [156mm]
E = 5 1/2" [140mm]

Accessories

L100 Series Filters and lenses
L1955 Concentrator
L200 Baffle

L1770

For use with: 75W 12V MR16
L = 4 1/8" [105mm]
W = 2 7/8" [73mm]
W1 = 6 3/8" [162mm]
E = 6 1/2" [165mm]

Accessories

L100 Series Filters and lenses

ENERGY DATA:

L1760

Type: Core and Coil
Line Amps 0.50A
Total Input Watts: 53W
Power Factor: >9
% THD: <12

L1770

Type: Core and Coil
Line Amps 0.70A
Total Input Watts: 78W
Power Factor: >95
% THD: <6

ADV990399

ACCESSORIES

L100 Series Optical Lenses**L110N=Diffuse Sandblasted Lens**

Provides an even beam spread from MR16 lamps - especially useful in wall washing

L111=Soft Focus Lens

Smooths irregular beam pattern while maintaining high controlled illumination levels and beam angles of MR16 lamps

L113=Prismatic Spread Lens

Provides a symmetrical broadening of MR16 lamp beams. Suitable when a wide, uniform light distribution is required.

L115=Linear Spread Lens

Fans out the MR16 beam 55° (27 1/2° to each side) to produce a wide rectangular pattern

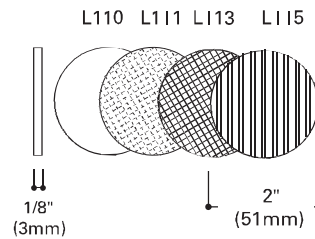
**L100 Series Lenses****2" UV AND COLOR FILTERS**

For use with MR 16 Lampholders. Provides either a soft or intense hue to accent a lighting installation. Replaces the glass shield provided with the lampholder

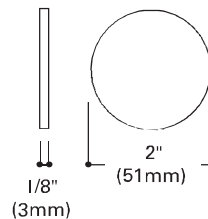
L112=Red Gel Filter**L130=Yellow Gel Filter****L114=Ultraviolet, Dichroic Filter****L131=Amber Gel Filter****L120=Red, Dichroic Filter****L121=Amber, Dichroic Filter****L122=Yellow, Dichroic Filter****L123=Green, Dichroic Filter****L124=Daylight Blue, Dichroic Filter****L125=Blue, Dichroic Filter****L127=Cosmetic (2700°K) Dichroic Filter****Color Filters****Accessory Baffle****L200=Reduces spill light**

Color Code: MB

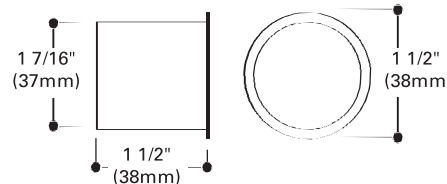
**Baffle****Beam Concentrator****L1955=Concentrates beam of MR16FL lamp to produce a well defined round spot of light.**

Comes with three auxiliary round beam templates for choice of beam angle size

Color Code: MB

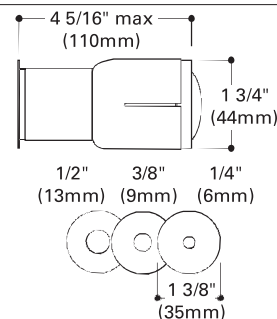
**Beam Concentrator**

Note: Specifications and Dimensions subject to change without notice.

Visit our website at www.cooperlighting.com