

# COOPER LIGHTING - METALUX®

## DESCRIPTION

The WS Series is a specification wraparound luminaire featuring energy efficient performance. The luminaire's characteristic clean, low profile design is both appealing and practically functional. The WS Series utilizes a clear, low brightness, extruded acrylic refractor with injection molded end caps for high performance and good looks.

The efficient and stylish WS Series is the perfect wraparound for commercial spaces, schools, dormitories, offices and retail areas.

Catalog #		Type
Project		
Comments		Date
Prepared by		

## SPECIFICATION FEATURES

### A ... Construction

Housing die formed code gauge prime cold rolled steel. Six full length ribs for strength. Embossed pad under ballast for better heat dissipation. 3/8" stand off embossments for cooler operation and low density applications. Ballast cover easily removed without tools. Steel end plates with 7/8" KO and light-seal embossment. Optional decorative end plate available.

### B ... Electrical\*

Ballasts are CBM/ETL Class "P" and are positively secured by mounting bolts. Pressure lock lampholders. UL/CUL listed. Suitable for damp locations.

### C ... Finish

Multistage, iron phosphate pretreatment ensures maximum bonding and rust inhibitor. Lighting grade, baked white enamel finish.

### D ... Frame/Shielding

100% clear full thickness virgin acrylic prismatic refractor/lens. Permanent luminous injection molded end caps. Sides have inside linear prisms and bottom has pyramidal prisms for low brightness control. Lens can be hinged from either side in a lift and shift manner.



**WS**  
420  
417  
440  
432

**4' OR 8' SURFACE**  
**4 LAMPS**  
**Specification Wrap**

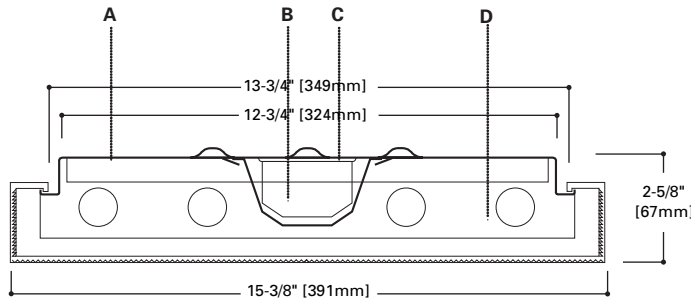

## MOUNTING DATA

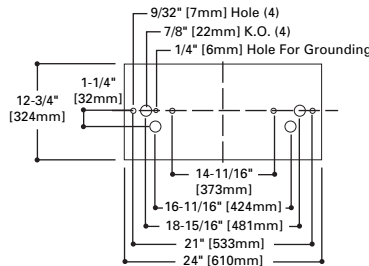
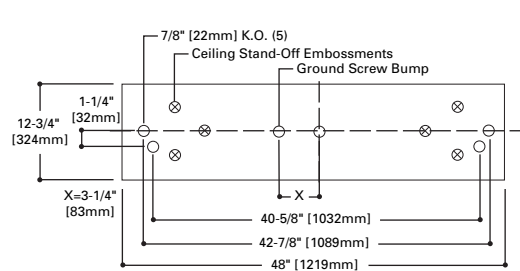
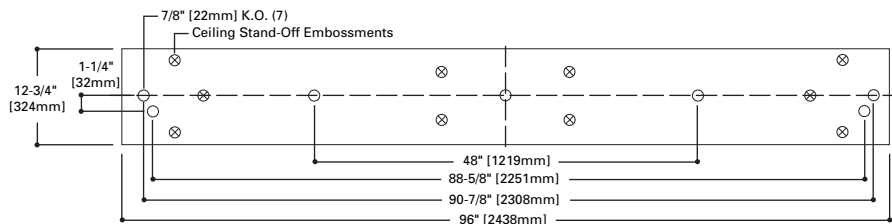

## LAMP CONFIGURATIONS

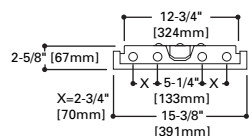

## LIFT & SHIFT REFRACTOR

Easily Removed. Hinges Either Side  
(Not Recommended For Sloped Ceiling Applications.)

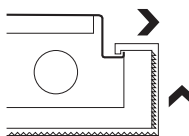

## ENERGY DATA

Input Watts:

**EB Ballast & STD Lamps**

417 (72)

440 (144)

432 (122)

**ES Ballast & STD Lamps**

420 (58)

417 (90)

440 (172)

432 (142)

Luminaire Efficacy Rating

**LER = FW-70**

**Catalog Number: WS-432A**

**Yearly Cost of 1000 lumens,**

**3000 hrs at .08 KWH = \$3.43**

\*Reference the lamp/ballast data in the Technical Section for specific lamp/ballast requirements.

LAMPS CONTAIN MERCURY. DISPOSE ACCORDING TO LOCAL, STATE OR FEDERAL LAWS

**LINEAR DISCONNECT**  
Safe and convenient means of disconnecting power



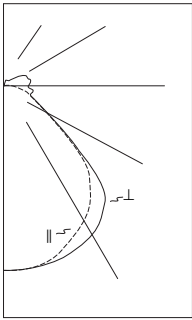

**WS-432A**  
Energy Saving  
Ballast

F32T8/35K Lamps  
2850 Lumens

Spacing criterion:  
( $\parallel$ ) 1.3 x mounting  
height, ( $\perp$ ) 1.4 x  
mounting height

Efficiency 76.3%

Test Report:  
WS432A.IES

LER = FW-70

Yearly Cost of 1000  
lumens, 3000 hrs at  
.08 KWH = \$3.43

**Coefficients of Utilization**

rc	Effective floor cavity reflectance																	
	80%				70%				20%									
rw	70	50	30	10	70	50	30	10	50	30	10	50	30	10	50	30	10	0
<b>RCR</b>																		
0	89	89	89	89	86	86	86	86	80	80	80	74	74	74	69	69	69	67
1	81	78	75	72	79	76	73	70	71	68	67	66	64	63	62	61	59	57
2	75	69	65	61	72	67	63	59	63	60	57	59	56	54	56	53	51	49
3	69	62	56	52	67	60	55	51	57	52	49	53	50	47	50	47	45	43
4	64	55	49	45	61	54	48	44	51	46	42	48	44	41	45	42	39	38
5	59	50	43	39	56	48	42	38	46	41	37	43	39	36	41	37	34	33
6	54	45	38	34	52	43	38	33	41	36	32	39	35	31	37	33	30	29
7	50	40	34	29	48	39	33	29	37	32	28	35	31	27	34	30	27	25
8	46	36	30	26	44	35	29	25	33	28	25	32	27	24	30	26	23	22
9	42	32	26	22	41	32	26	22	30	25	21	29	24	21	27	23	20	19
10	39	29	24	20	38	29	23	19	27	22	19	26	22	18	25	21	18	17

**Zonal Lumen Summary**

Zone	Lumens	%Lamp	%Fixture
0-30	2328	20.4	26.8
0-40	3875	34.0	44.6
0-60	6359	55.8	73.1
0-90	7651	67.1	88.0
90-180	1046	9.2	12.0
0-180	8697	76.3	100.0

**Typical VCP Percentages**

Room Size (Ft.)	Height Along		Height Across	
	8.5'	10.0'	8.5'	10.0'
20 x 20	60	65	61	66
30 x 30	53	58	52	57
30 x 60	44	47	38	43
60 x 30	55	59	54	59
60 x 60	45	48	39	44

**Candela**

Angle	Along $\parallel$	45°	Across $\perp$
0	2909	2909	2909
10	2864	2879	2896
20	2718	2788	2851
30	2474	2612	2713
40	2111	2318	2455
50	1368	1565	1403
60	714	800	758
70	413	488	443
80	230	296	481
90	24	152	369
100	27	249	438
110	34	279	397
120	40	214	311
130	43	135	157
140	44	107	118
150	46	83	107
160	43	59	83
170	37	41	46
180	33	33	33

**ORDERING INFORMATION**

Sample Number: WS-432A-120V-EB81-U

<b>Tandem</b> Blank=4' Length 8T=8' Length	<b>Series 1</b> WS=Specification Surface Wrap	<b>Width</b> (blank)=Standard A=Wide Body for 2 Lamps	<b>Number of Lamps 2,3</b> 4 Lamps (Not Included)	<b>Wattage</b> 20: 20W T12 (24") 17: 17W T8 (24") 32: 32W T8 (48") 40: 40W T12 (48")	<b>Lens</b> A=Acrylic Refractor Lens	<b>Ballast Start Type</b> LTS=Low Trigger Start (20W only) (120V only) HTS=High Trigger Start (20W only)	<b>Voltage 4</b> 120V=120 Volt 277V=277 Volt 347V=347 Volt UNV= Universal Voltage <sup>5</sup> 120-277	<b>Options</b> GL= Single Element Fuse GM= Double Element Fuse EL= Emergency Installed	<b>Ballast Type 4</b> Blank=Standard Magnetic T12 Ballast EB=Electronic Instant Start ER=T8 Electronic Program Rapid Start. Total Harmonic Distortion < 10% DLS=Digital Lighting System Dimming	<b>Lamp Size</b> 2=T12 8=T8	<b>Number of Ballasts</b> 1= 1 Ballast 2= 2 Ballast	<b>Options</b> PLUS=Higher Ballast Factor > 1.13. Total Harmonic Distortion < 20% RIF1=Radio Interference Suppressor	<b>Packaging</b> U=Unit Pack
--	---	---	--	--	---	---	---	---	---	-----------------------------------	---	---	---------------------------------

**ACCESSORIES**

(Order Separately)

SCF=Fixed Stem Set (Specify Length)  
SCS=Swivel Stem Set (Specify Length)  
SCA=Adjustable 48" Stem Set  
A1B/Spacer-U=Spacer 1-1/2" to 2-1/2"  
from ceiling (Use 2 per fixture)  
Lengths Available: 6, 8, 12, 18, 24, 36, 48

(Additional Accessories Available. See Options  
and Accessories Section.)

**SHIPPING INFORMATION**

Catalog No.	Wt.
WS-417A	8 lbs.
WS-432A	17 lbs.
8TWS-432A	33 lbs.

- Notes: 1 Steel endplates with 7/8" KO standard for continuous row mounting.  
 2 Stem Mounting not available on 3-lamp fixtures.  
 3 2 point suspension recommended for 2 and 4-lamp fixtures.  
 4 Products also available in non-US voltage and frequencies for international markets  
 5 Not Available when specifying emergencies, voltage must be specific

**Specifications and Dimensions subject to change without notice.**

Metalux • Customer First Center • 1121 Highway 74 South • Peachtree City, GA 30269 • TEL 770.486.4800 • FAX 770.486.4801