

Series 2, 3, 4, & 5 Aluminum - Accessories

Wedge Lock Splice Plates

- Standard 4-hole pattern.
- Furnished in pairs, with hardware.
- One pair including hardware provided with each section.
- Boxed in pairs with hardware.
- For field installation drill $\frac{13}{32}$ " hole.

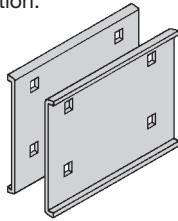

Catalog No.	Height	
	in.	mm
● 9A-1004	4	101
● 9A-1005	5	127
● 9A-1006	6	152
● 9A-1007	7	178

H46A, H47A and 57A Mid-Span Splice

- Standard for H46A, H47A and 57A straight sections.
- Six bolt design $\frac{1}{2}$ " Stainless Steel Type 316 hardware standard.
- Available on ladder bottoms only. 09 and 12" rung spacing.
- Furnished in pairs with hardware.

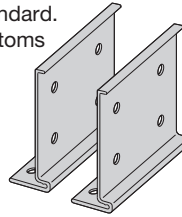

Tray Series	Catalog No.
H46A	● 9A-6006
H47A, 57A	● 9A-6007

Expansion Splice Plates

- Expansion plates allow for one inch expansion or contraction of the cable tray, or where expansion joints occur in the supporting structure.
- Furnished in pairs with hardware.
- **Bonding Jumpers are required on each siderail.**
Order Separately.

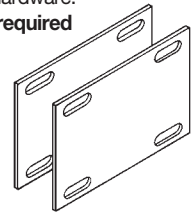

For heavy duty expansion splice plates see page APP-3.

Catalog No.	Height	
	in.	mm
● 9A-1014	4	101
● 9A-1015	5	127
● 9A-1016	6	152
● 9A-1017	7	178

Universal Splice Plates

- Used to splice to existing cable tray systems.
- Furnished in pairs with hardware.

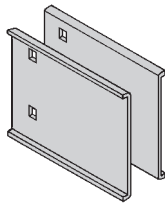

Catalog No.	Height	
	in.	mm
● 9A-1004- $\frac{1}{2}$	4	101
● 9A-1005- $\frac{1}{2}$	5	127
● 9A-1006- $\frac{1}{2}$	6	152
● 9A-1007- $\frac{1}{2}$	7	178

Step Down Splice Plates

- These splice plates are offered for connecting cable tray sections having side rails of different heights.
- Furnished in pairs with hardware.

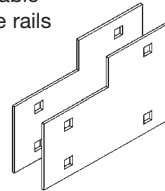

Catalog No.	Height	
	in.	mm
● 9A-1045	5 to 4	127 to 101
● 9A-1046	6 to 4	152 to 101
● 9A-1060	6 to 5	152 to 127
● 9A-1047	7 to 4	178 to 101
● 9A-1061	7 to 5	178 to 127
● 9A-1062	7 to 6	178 to 152

Vertical Adjustable Splice Plates

- These plates provide for changes in elevation that do not conform to standard vertical fittings.
- Furnished in pairs with hardware.
- **Bonding Jumper not required.**

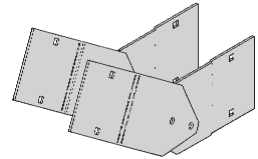

Requires supports within 24" on both sides, per NEMA VE 2.

Catalog No.	Height	
	in.	mm
● 9A-1024	4	101
● 9A-1025	5	127
● 9A-1026	6	152
● 9A-1027	7	178

Horizontal Adjustable Splice Plates

- Offered to adjust a cable tray run for changes in direction in a horizontal plane that do not conform to standard horizontal fittings.
- Furnished in pairs with hardware.
- New design bonding jumpers **not** required.
- (X) Insert 4, 5, 6 or 7 for side rail height.

9A-103(X)-12 or 9A-103(X)-36
One pair splice plates with extensions.

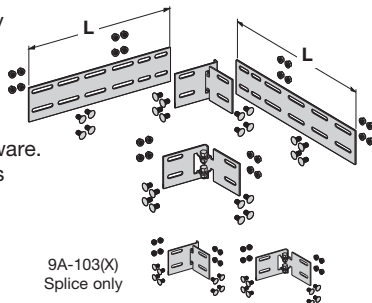

Catalog No.	Cable Tray End Cut	Tray Width	'L'
● 9A-103(X)	Mitered	Thru 36"	N/A
● 9A-103(X)-12	Not mitered	Thru 12"	16"
● 9A-103(X)-36	Not mitered	Thru 36"	41"

Requires supports within 24" on both sides, per NEMA VE 2.

Branch Pivot Connectors

- Branch from existing cable tray runs at any point.
- Pivot to any required angle.
- UL Classified for grounding (bonding jumper not required).
- Furnished in pairs with hardware.

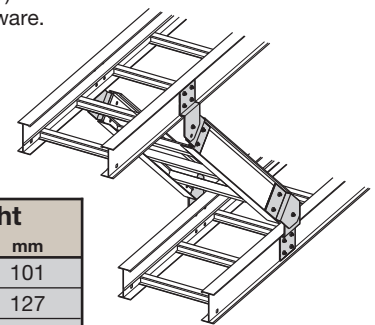

Catalog No.	Height	
	in.	mm
● 9A-2044	4	101
● 9A-2045	5	127
● 9A-2046	6	152
● 9A-2047	7	178

● Green = Fastest shipped items ● Black = Normal lead-time items ● Red = Normally long lead-time items