

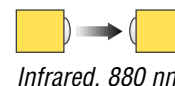

Features

- Choose models for 10 to 30V dc or 24 to 250V ac operation.
- DC models have bipolar solid-state outputs: one NPN (sinking) and one PNP (sourcing).
- AC models have an SPST solid-state output rated for up to 3/4 amp with simple 2-wire hookup.
- All models have a rear panel sensitivity adjustment and light/dark operate switch.
- DC models include Banner's Alignment Indicating Device (AID™) system.
- Choose models with integral 2 m (6.5') cable or Mini-style QD (quick-disconnect) connector; 9 m (30') cables are also available.

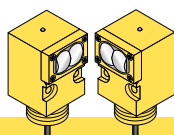

Opposed Mode Emitter (E) and Receiver (R) Models

Models	Range	Cable*	Supply Voltage	Output Type	Excess Gain	Beam Pattern
SMA91E SMA91EQD	60 m (200')	2 m (6.5') 3-Pin Mini QD	10-250V ac/dc	—		<p>Effective Beam: 13 mm</p>
SM91R SM91RQD		2 m (6.5') 4-Pin Mini QD	10-30V dc	Bipolar NPN/PNP		
SM2A91R SM2A91RQD		2 m (6.5') 3-Pin Mini QD	24-250V ac	SPST SCR Solid-state 2-Wire		
SMA91ESR SMA91ESRQD	3 m (10')	2 m (6.5') 3-Pin Mini QD	10-250V ac/dc	—		<p>Effective Beam: 3.5 mm</p>
SM91RSR SM91RSRQD		2 m (6.5') 4-Pin Mini QD	10-30V dc	Bipolar NPN/PNP		
SM2A91RSR SM2A91RSRQD		2 m (6.5') 3-Pin Mini QD	24-250V ac	SPST SCR Solid-state 2-Wire		

* 9 m cables are available by adding suffix "W/30" to the model number of any cabled sensor (e.g., SMA91E W/30).
A model with a QD connector requires a mating cable; see page 7.



WARNING . . . Not To Be Used for Personnel Protection

Never use these products as sensing devices for personnel protection. Doing so could lead to serious injury or death.

These sensors do NOT include the self-checking redundant circuitry necessary to allow their use in personnel safety applications. A sensor failure or malfunction can cause either an energized or de-energized sensor output condition. Consult your current Banner Safety Products catalog for safety products which meet OSHA, ANSI and IEC standards for personnel protection.

VALU-BEAM® Sensors – 912 Series

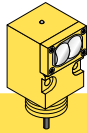

Retroreflective Mode Models

Models	Range†	Cable*	Supply Voltage	Output Type	Excess Gain	Beam Pattern
Non-Polarized						
SM912LV SM912LVQD	0.15 to 9 m (6" to 30')	2 m (6.5') 4-Pin Mini QD	10-30V dc	Bipolar NPN/PNP		
SM2A912LV SM2A912LVQD		2 m (6.5') 3-Pin Mini QD	24-250V ac	SPST SCR Solid-state 2-Wire		
Polarized††						
SM912LVAG SM912LVAGQD	0.3 to 4.5 m (1' to 15')	2 m (6.5') 4-Pin Mini QD	10-30V dc	Bipolar NPN/PNP		
SM2A912LVAG SM2A912LVAGQD		2 m (6.5') 3-Pin Mini QD	24-250V ac	SPST SCR Solid-state 2-Wire		

†Retroreflective range is specified using one model BRT-3 retroreflector (3" diameter). Actual sensing range may be more or less than specified, depending upon the efficiency and reflective area of the retroreflector used.

††Use polarized models when shiny objects will be sensed.

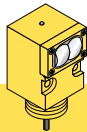

Diffuse Mode Models

Models	Range†	Cable*	Supply Voltage	Output Type	Excess Gain	Beam Pattern
					Performance based on 90% reflectance white test card	
SM912D SM912DQD	760 mm (30")	2 m (6.5') 4-Pin Mini QD	10-30V dc	Bipolar NPN/PNP		
SM2A912D SM2A912DQD		2 m (6.5') 3-Pin Mini QD	24-250V ac	SPST SCR Solid-state 2-Wire		
SM912DSR SM912DSRQD	380 mm (15")	2 m (6.5') 4-Pin Mini QD	10-30V dc	Bipolar NPN/PNP		
SM2A912DSR SM2A912DSRQD		2 m (6.5') 3-Pin Mini QD	24-250V ac	SPST SCR Solid-state 2-Wire		

VALU-BEAM® Sensors – 912 Series

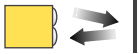

Visible Red or Infrared; see below

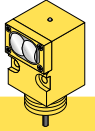

Convergent Mode Models

Models	Range	Cable*	Supply Voltage	Output Type	Excess Gain	Beam Pattern
					Performance based on 90% reflectance white test card	
Visible Red 650 nm						
SM912CV SM912CVQD	38 mm (1.5")	2 m (6.5') 4-Pin Mini QD	10-30V dc	Bipolar NPN/PNP		
SM2A912CV SM2A912CVQD	Spot Size at Focus: 1.5 mm (0.06")	2 m (6.5') 3-Pin Mini QD	24-250V ac	SPST SCR Solid-state 2-Wire		
Infrared 880 nm						
SM912C SM912CQD	38 mm (1.5")	2 m (6.5') 4-Pin Mini QD	10-30V dc	Bipolar NPN/PNP		
SM2A912C SM2A912CQD		2 m (6.5') 3-Pin Mini QD	24-250V ac	SPST SCR Solid-state 2-Wire		



Infrared, 880 nm

Use where the separation between emitting and receiving fibers is more than a few feet, or where it is inconvenient to run both fibers from a single sensor. Watertight o-ring-sealed sensor/fiber interface.

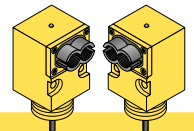

Glass Fiber Optic Individual Emitter or Receiver Models

Models	Range	Cable*	Supply Voltage	Output Type	Excess Gain	Beam Pattern
SMA91EF SMA91EFQD	Range varies with fiber used	2 m (6.5') 3-Pin Mini QD	10-250V ac/dc	—		
SM91RF SM91RFQD		2 m (6.5') 4-Pin Mini QD	10-30V dc	Bipolar NPN/PNP		
SM2A91RF SM2A91RFQD		2 m (6.5') 3-Pin Mini QD	24-250V ac	SPST SCR Solid-state 2-Wire		

*9 m (30') cables are available by adding suffix "W/30" to the model number of any cabled sensor (e.g., SMA91EF W/30). A model with a QD connector requires a mating cable; see page 7.

VALU-BEAM® Sensors – 912 Series

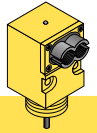

Watertight o-ring-sealed sensor/fiber interface.



Infrared, 880 nm

Glass Fiber Optic Models

Models	Range	Cable*	Supply Voltage	Output Type	Excess Gain	Beam Pattern
					Performance based on 90% reflectance white test card	
SM912F SM912FQD	Range varies with sensing mode and fiber optics used.	2 m (6.5') 4-Pin Mini QD	10-30V dc	Bipolar NPN/PNP		
SM2A912F SM2A912FQD		2 m (6.5') 3-Pin Mini QD	24-250V ac	SPST SCR Solid-state 2-Wire		

* 9 m (30') cables are available by adding suffix "W/30" to the model number of any cabled sensor (e.g., SM912F W/30).

A model with a QD connector requires a mating cable; see page 7.

Dimensions

Cabled Models

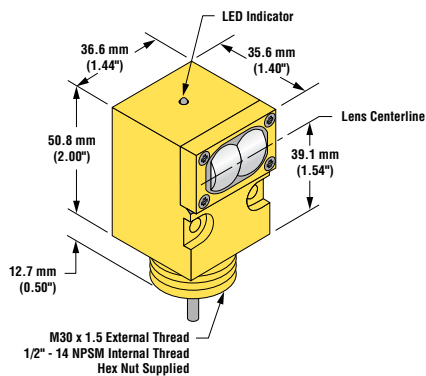

QD Models

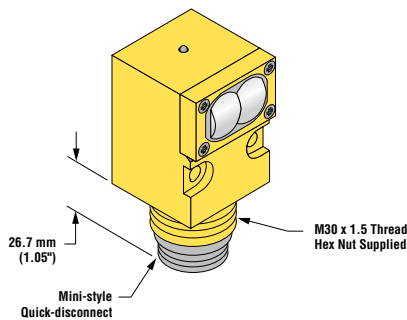

Rear View

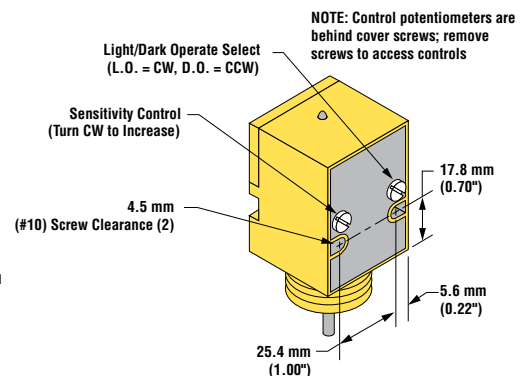

Convergent Sensing Mode (model suffix LVAG, C and CV)

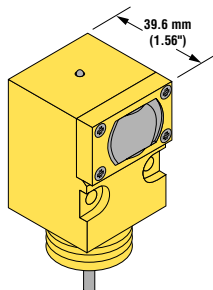

Glass Fiber Optic (model suffix F, EF and RF)

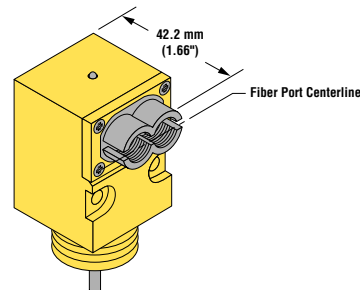

VALU-BEAM® Sensors – 912 Series

Specifications – DC Models

Supply Voltage and Current	10 to 30V dc at 20 mA maximum, exclusive of load (except for SMA91E, ESR and EF emitters, which operate from 10 to 250V ac or dc, 10 mA max.)
Supply Protection Circuitry	Protected against reverse polarity and transient voltages
Output Configuration	Bipolar: One current sourcing (PNP) and one current sinking (NPN) open-collector transistor
Output Rating	250 mA continuous, each output Off-state leakage current: less than 10 microamps Output saturation voltage: (PNP output) less than 1 volt at 10 mA and less than 2 volts at 250 mA Output saturation voltage: (NPN output) less than 200 millivolts at 10 mA and less than 1 volt at 250 mA
Output Protection Circuitry	Protected against false pulse on power-up and continuous overload or short-circuit of outputs
Output Response Time	Receivers only: 8 milliseconds ON and 4 milliseconds OFF, independent of signal strength. All other models: 4 milliseconds ON/OFF NOTE: 100 millisecond delay on power-up; outputs do not conduct during this delay.
Repeatability	Opposed and Glass Fiber Optic Emitter-Receiver pairs: 1.0 millisecond Retro, Diffuse, Convergent and Glass Fiber Optic Models: 1.3 milliseconds
Adjustments	Light/Dark Operate select switch and Sensitivity control potentiometer, both located at rear of sensor
Indicators	Alignment Indicating Device (AID™) lights a top-mounted red LED indicator whenever the sensor sees a “light” condition; its pulse rate is proportional to the light signal strength (the stronger the signal, the faster the pulse rate). Model SMA91E and SM91ESR emitters: visible-red “tracer beam” indicates “Power ON” and enables line-of-sight alignment.
Construction	Reinforced thermoplastic polyester housing, totally encapsulated, molded acrylic lenses and stainless steel hardware
Environmental Rating	Meets NEMA standards 1, 2, 3, 3S, 4, 4X, 12 and 13; IEC IP66
Connections	PVC-jacketed 2 m (6.5') or 9 m (30') cables or 4-pin Mini-style quick-disconnect (QD) fitting available. NOTE: Opposed-mode emitters use 3-pin Mini-style QD fitting. See page 7.
Operating Conditions	Temperature: -20° to +70° C (-4° to +158° F) Maximum relative humidity: 90% at 50° C (non-condensing)
Certifications	CE SP® UL

DC Hookups

Emitters – Cabled

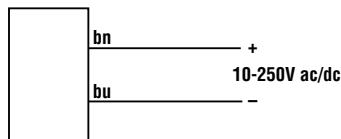

Emitters – QD
(3-Pin Mini-Style)

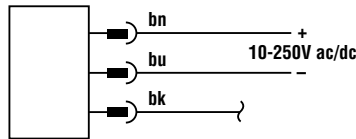

3-Pin Mini-Style Pinout
(Cable Connector Shown)

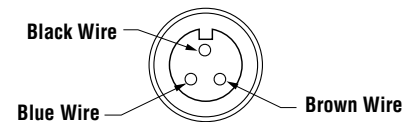

Other DC Models – Cabled

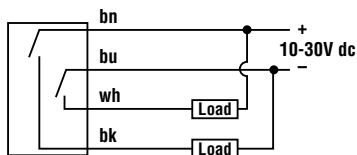

Other DC Models – QD
(4-Pin Mini-Style)

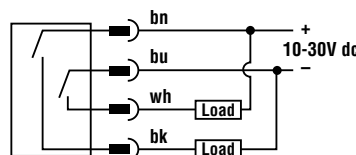

4-Pin Mini-Style Pinout
(Cable Connector Shown)

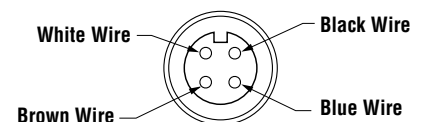

VALU-BEAM® Sensors – 912 Series

Specifications – AC Models

Supply Voltage and Current	24 to 250V ac (50/60 Hz), except for SMA91E, ESR and EF emitters, which operate from 10 to 250V ac or dc
Supply Protection Circuitry	Protected against transient voltages
Output Configuration	SPST SCR solid-state relay with either normally closed or normally open contact (light/dark operate selectable); 2-wire hookup
Output Rating	Minimum load current 10 mA, max. steady-state load capability 750 mA to 50° C ambient (122° F), 500 mA to 70° C ambient (158° F) Inrush capability: 4 amps for 1 second (non-repetitive) Off-state leakage: current less than 1.7 mA rms On-state voltage drop: 5 volts rms at 750 mA load, 10 volts rms at 15 mA load
Output Protection Circuitry	Protected against false pulse on power-up
Output Response Time	Receivers only: 8 milliseconds ON and 4 milliseconds OFF, independent of signal strength All other models: 8 milliseconds ON and OFF OFF time does not include load response of up to 1/2 ac cycle (8.3 milliseconds). Response time specification of the load should be considered when total response time is important. NOTE: 300 millisecond delay on power-up; outputs do not conduct during this delay.
Repeatability	Opposed and Glass Fiber Optic Emitter-Receiver pairs: 1.0 millisecond Retro, Diffuse, Convergent and Glass Fiber Optic: 2.6 milliseconds
Adjustments	Light/Dark Operate select switch and Sensitivity control potentiometer, both located at rear of sensor
Indicators	Top-mounted red LED indicator lights when output is conducting. Model SMA91E and SM91ESR emitters: visible-red “tracer beam” indicates “Power ON” and enables line-of-sight alignment.
Construction	Reinforced thermoplastic polyester housing, totally encapsulated, molded acrylic lenses and stainless steel hardware
Environmental Rating	Meets NEMA standards 1, 2, 3, 3S, 4, 4X, 12 and 13; IEC IP66
Connections	PVC-jacketed 2 m (6.5') or 9 m (30') cables or 3-pin Mini-style (QD) fitting available. See page 7.
Operating Conditions	Temperature: -20° to +70° C (-4° to +158° F) Maximum relative humidity: 90% at 50° C (non-condensing)
Application Notes	i) 912 Series ac sensors can be destroyed from overload conditions. ii) Use on low voltage requires careful analysis of the load to determine if the leakage current or on-state voltage of the sensor will interfere with proper operation of the load. iii) The false-pulse protection feature may cause momentary drop-out of the load when the sensor is wired in series or parallel with mechanical switch contacts.
Certifications	

AC Hookups

Emitters – Cabled

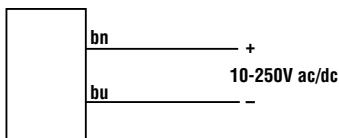

Emitters – QD (3-Pin Mini-Style)

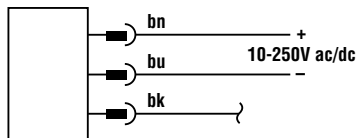

Other AC Models – Cabled

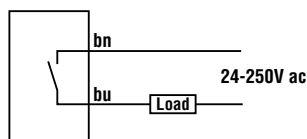

Other AC Models – QD (3-Pin Mini-Style)

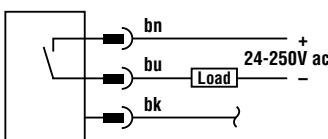

3-Pin Mini-Style Pinout (Cable Connector Shown)

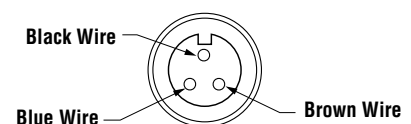

VALU-BEAM® Sensors – 912 Series

Accessories

Quick-Disconnect Cables

Cable: PVC jacket, polyurethane connector body; nylon coupling nut
Conductors: 18 AWG, high-flex stranded, PVC insulation, gold plated contacts
Temperature: -40° to +80° C (-40° to +176° F)

Style	Model	Length	Dimensions	Pinout (Female View)	
3-Pin Mini-style Female, Straight	MBCC-306	2 m (6.5')			
	MBCC-312	4 m (12')			
	MBCC-330	9 m (30')			
4-Pin Mini-style Female, Straight	MBCC-406	2 m (6.5')			
	MBCC-412	4 m (12')			
	MBCC-430	9 m (30')			

Cabling Accessories

Model	Description	
AC-6	2 m (6.5') armored cable jacket	I.D. 5/16"; O.D. 7/16"
PVC-6	2 m (6.5') flexible PVC tubing (not for QD models)	I.D. 1/4"; O.D. 3/8"
RF1-2NPS	Compression fitting for attaching armored cable or PVC tubing	—
HF1-2NPS	<ul style="list-style-type: none"> Flexible black nylon cable protector Includes a neoprene gland that compresses around the VALU-BEAM cable to provide an additional seal against moisture Resistant to gasoline, alcohol, oil, grease, solvents and weak acids Working temperature range of -30° to +100° C (-22° to +212° F) 	

Extension Cables (without connectors)

The following cables are available for extending the length of existing sensor cable. These are 30 m (100') lengths of VALU-BEAM cable. This cable may be spliced to existing cable. Connectors, if used, must be customer-supplied.

Model	Type	Used With:
EC312-100	4-conductor	SM912 Series dc sensors
EC312A-100	2-conductor	For all emitters and SM2A912 Series ac sensors

Retroreflective Targets

Banner offers a wide selection of high-quality retroreflective targets. See the Accessories section of your current Banner Photoelectric Sensors catalog for complete information.

NOTE: Polarized sensors require corner cube type retroreflective targets. Non-polarized sensors may use any retroreflective target.

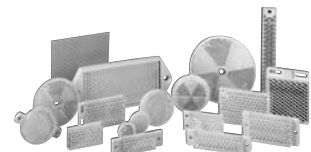

VALU-BEAM® Sensors – 912 Series

Replacement Lens Assemblies

VALU-BEAM lens assemblies are field-replaceable. In addition, some lenses may be used to convert from one sensing mode to another, or to change the sensing range of a particular sensor. The possible conversions are listed in the table below.

Models	Description	Possible Sensing Mode or Range Changes
UC-900AG	Replacement lens for LVAG	Change LV to LVAG
UC-900C	Replacement lens for C and CV	Change LV to CV
UC-900DSR	Replacement lens for DSR, ESR, and RSR	Change D or F to DSR, EF to ESR, and RF to RSR
UC-900F	Replacement lens for F	Change D to F and DSR to F
UC-900FP	Replacement lens for FP	–
UC-900L	Replacement lens for E, R, LV, and D	Change LVAG to LV, CV to LV, DSR to D, and F to D
UC-900J	Attach to E, R, ESR, RSR, LV, and D models	Flat polycarbonate dust cover

Mounting Brackets

SMB30C	<ul style="list-style-type: none"> • 30 mm split clamp, black PBT bracket • Stainless steel mounting hardware included 	SMB30SC	<ul style="list-style-type: none"> • 30 mm swivel, black PBT bracket • Stainless steel mounting hardware included
SMB30MM	<ul style="list-style-type: none"> • 30 mm, 12-gauge stainless steel bracket with curved mounting slots for versatile orientation • Clearance for M6 (1/4") hardware 	<div style="text-align: center;">  <p>more sensors, more solutions</p> </div> <div style="border: 1px solid black; padding: 10px; margin-top: 20px;"> <p>WARRANTY: Banner Engineering Corp. warrants its products to be free from defects for one year. Banner Engineering Corp. will repair or replace, free of charge, any product of its manufacture found to be defective at the time it is returned to the factory during the warranty period. This warranty does not cover damage or liability for the improper application of Banner products. This warranty is in lieu of any other warranty either expressed or implied.</p> </div>	