

- Compact, modulated, self-contained infrared fiber optic sensors for 24-240V ac 2-wire operation
- Useable in opposed, retroreflective, and diffuse fiber optic modes with Banner glass fiber optic assemblies
- Switch-selectable for light operate or dark operate
- 8 millisecond response
- SPST SCR solid-state output switches up to 300 mA; low leakage current and saturation voltage
- Rugged, epoxy-encapsulated construction: meets NEMA standards 1, 2, 3, 3S, 4, 4X, 12 and 13; IEC IP67

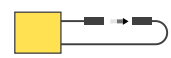

Infrared, 880 nm

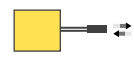
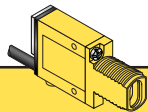

MINI-BEAM Glass Fiber Optic

Models	Range	Cable	Supply Voltage	Output Type	Excess Gain	Beam Pattern
					Diffuse mode performance based on 90% reflectance white test card	
SM2A312F SM2A312FQD	Range varies by sensing mode and fiber optics used	2 m (6.5 ft) 3-Pin Micro QD	24-240V ac	SPST Solid-state 2-wire		

For Standard MINI-BEAMS:

- 9 m (30 ft) cables are available by adding suffix "W/30" to the model number of any cabled sensor (e.g. - SM2A312F W/30).
- A 150 mm (6 in.) long pigtail cable with attached QD connector is available by adding suffix "QDP" to the model number of any MINI-BEAM sensor (e.g. - SM2A312FQDP). See page 5 for more information.
- A model with a QD connector requires an accessory mating cable. See page 5 for more information.

MINI-BEAM Features

*** Note regarding Light/Dark operate switch:**

- Turn switch *fully* clockwise for light operate (sensor outputs conduct when sensing light is received)
- Turn switch *fully* counterclockwise for dark operate (sensor outputs conduct when sensing light is not received)

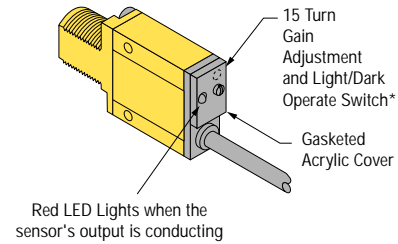

MINI-BEAM Fiber Information

- 1) Install the O-ring (supplied with the fiber) on each fiber end, as shown in the drawing.
- 2) While pressing the fiber ends firmly into the ports on the front of the sensor, slide the U-shaped retaining clip (supplied with the sensor) into the slot in the sensor's barrel, until it snaps into place.

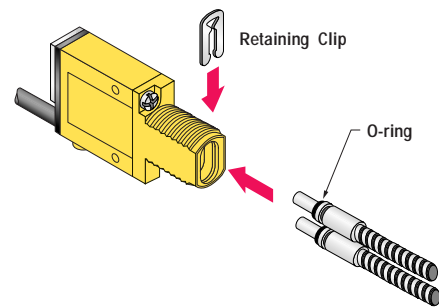

Lens Attachment

Lenses are sometimes added to fiber optic assemblies for extending opposed mode sensing range. Banner offers the following lens assemblies for use with fiber optic assemblies which have 5/16" -24 threaded sensing tips (e.g. fiber model IT23S):

Model	Lens Size	Focal Length	Housing	Notes
L9	12.5 mm (1/2")	12.5 mm (1/2")	Aluminum	Suitable for all but highly corrosive environments
L16F	25 mm (1")	44 mm (1.7")	Delrin	Maximum operating temperature is 100° C (212° F)
L16FAL	25 mm (1")	44 mm (1.7")	Aluminum	Suitable for all but highly corrosive environments
L16FSS	25 mm (1")	44 mm (1.7")	Stainless Steel	Suitable for all environments

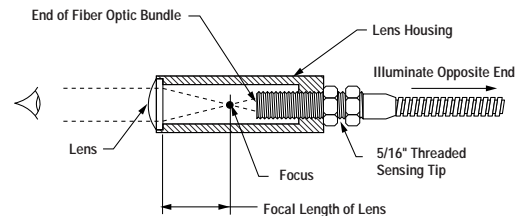

Lenses are most efficient when they are located slightly beyond their focal length distance from the sensing end of the fiber optic bundle. The easiest way to focus a lens is to treat it like a magnifying glass.

Illuminate the fiber optic bundle at the threaded end of the fiber optic assembly by directing the opposite end toward a visible light source (e.g. - an incandescent bulb, visible LED, sunlight, etc.). Thread the lens onto the fiber optic assembly until the end of the fiber optic bundle comes into sharp focus under the lens. Then, back off (unthread) the lens assembly from the point of sharpest focus by one to three full turns. The illuminated bundle should now appear slightly blurred. This is the optimum setting, and the lens may be secured in position using one of the jam nuts provided. Refer to the drawing above.

MINI-BEAM AC Product Specifications	
Supply Voltage and Current	24 to 240V ac (50/60 Hz), 250V ac max
Supply Protection Circuitry	Protected against transient voltages
Output Configuration	SPST SCR solid-state relay with either normally closed or normally open contact (light/dark operate selectable); 2-wire hookup
Output Rating	Minimum load current 5 mA; maximum steady-state load capability 300 mA to 50°C ambient (122°F) 100 mA to 70°C ambient (158°F) Inrush capability 3 amps for 1 second (non repetitive); 10 amps for 1 cycle (non repetitive) Off-state leakage current less than 1.7 mA rms On-state voltage drop ≤5 volts at 300 mA load, ≤10 volts at 15 mA load
Output Protection Circuitry	Protected against false pulse on power-up
Output Response Time	8 milliseconds on and off "OFF" response time specification does not include load response of up to ½ ac cycle (8.3 milliseconds). Response time specification of load should be considered when important. (NOTE: 300 millisecond delay on power-up.)
Repeatability	2.6 milliseconds; Response time and repeatability specifications are independent of signal strength.
Adjustments	LIGHT/DARK OPERATE select switch, and 15-turn slotted brass screw GAIN (sensitivity) adjustment potentiometer (clutched at both ends of travel). Both controls are located on rear panel of sensor and protected by a gasketed, clear acrylic cover.
Indicators	Red indicator LED on rear of sensor is "ON" when the load is energized
Construction	Reinforced VALOX® housing, totally encapsulated, o-ring sealing, acrylic lenses, and stainless steel screws
Environmental Rating	Meets NEMA standards 1, 2, 3, 3S, 4, 4X, 12, and 13; IEC IP67
Connections	PVC-jacketed 2-conductor 2 m (6.5ft) or 9 m (30ft) cables, or 3-pin micro-style quick disconnect (QD) fitting are available. QD cables are ordered separately. See page 5.
Operating Temperature	Temperature: -20° to +70°C (-4° to +158°F) Maximum Relative Humidity: 90% at 50°C (non-condensing)
Application Notes	i) ac MINI-BEAMs may be destroyed from overload conditions ii) Use on low voltage requires careful analysis of the load to determine if the leakage current or on-state voltage of the sensor will interfere with proper operation of the load iii) The false-pulse protection feature may cause momentary drop-out of the load when the sensor is wired in series or parallel with mechanical switch contacts
Certifications	

VALOX® is a registered trademark of General Electric Company

MINI-BEAM AC Hookup Diagrams

AC Sensors with Attached Cable

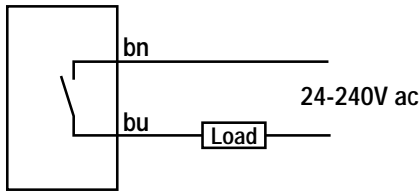

AC Sensors with Quick Disconnect (3-Pin Micro-Style)

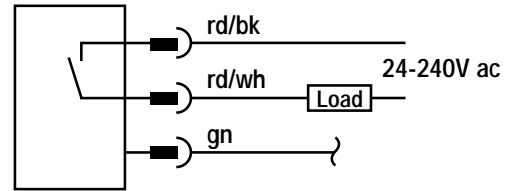

3-Pin Micro-Style Pin-out (Cable Connector Shown)

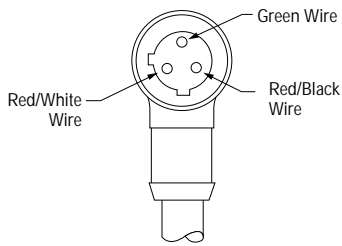

Quick Disconnect (QD) Option

AC MINI-BEAM sensors are sold with either a 2 m (6.5 ft) or a 9 m (30 ft) attached PVC-covered cable, or with a 3-pin micro-style QD cable fitting.

AC QD sensors are identified by the letters "QD" in their model number suffix. For more information on mating QD cables, see page 5.

MINI-BEAM Dimension Information

MINI-BEAM AC Sensor with Integral Cable

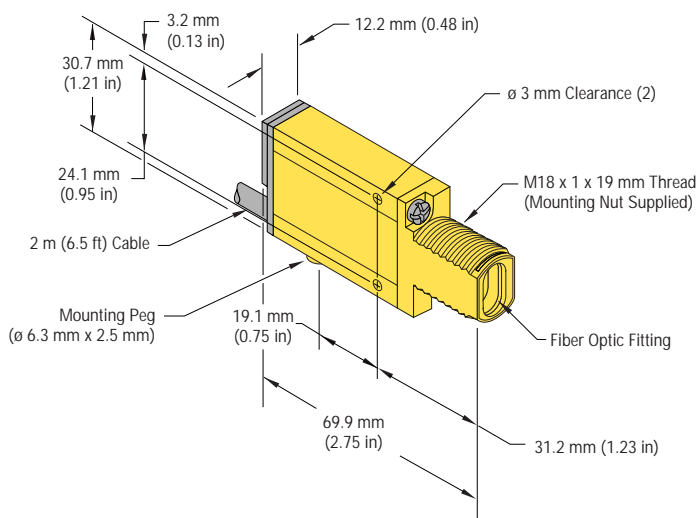

MINI-BEAM AC Sensor with Quick-Disconnect

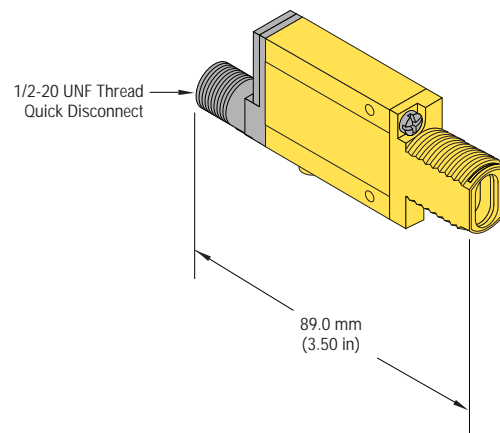





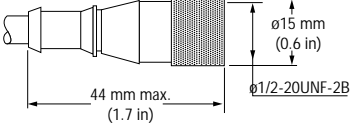
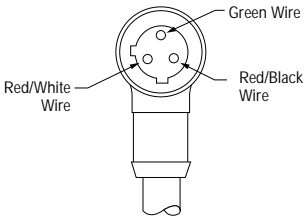
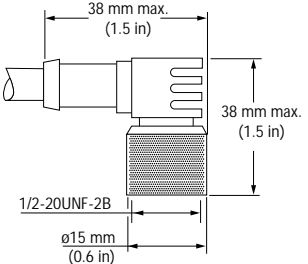

MINI-BEAM MODIFICATIONS			
Model Suffix	Modification	Description	Example of Model Number
W/30	9 meter (30 ft) cable	All MINI-BEAM sensors may be ordered with an integral 9 m (30 ft) cable in place of the standard 2 m (6.5 ft) cable	SM2A312F W/30
QDP	Pigtail Quick Disconnect	All MINI-BEAMs may be built with a 150 mm (6 in) long integral cable which is terminated with the appropriate QD connector. 	SM2A312FQDP

Extension Cables (without connectors)		
The following cables are available for extending the length of existing sensor cable. These are 30 m (100 ft) lengths of MINI-BEAM cable. This cable may be spliced to existing cable. Connectors, if used, must be customer-supplied.		
Model	Type	Used with:
EC312A-100	2-conductor	All MINI-BEAM SM2A312 ac models

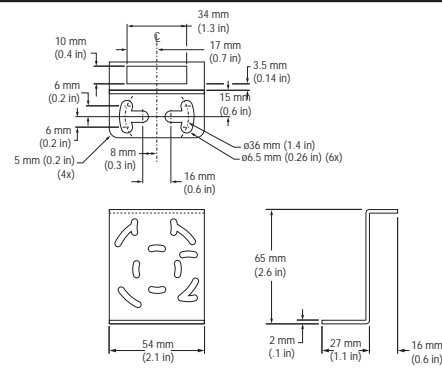
Micro-Style Quick Disconnect Cables				
<p>Cable: PVC jacket, polyurethane connector body, nickel-plated brass coupling nut Conductors: 22 or 20 AWG high-flex stranded, PVC insulation, gold-plated contacts Temperature: -40 to +80°C (-40 to +176°F) Voltage Rating: 250V ac/300V dc (3-pin), 125V ac/150V dc (4-pin)</p>				
				
Style	Model	Length	Dimensions	Pin-out
3-Pin Straight	MQDC-306 MQDC-315 MQDC-330	2 m (6.5 ft) 5 m (15 ft) 9 m (30 ft)		
3-Pin Right-angle	MQDC-306RA MQDC-315RA MQDC-330RA	2 m (6.5 ft) 5 m (15 ft) 9 m (30 ft)		

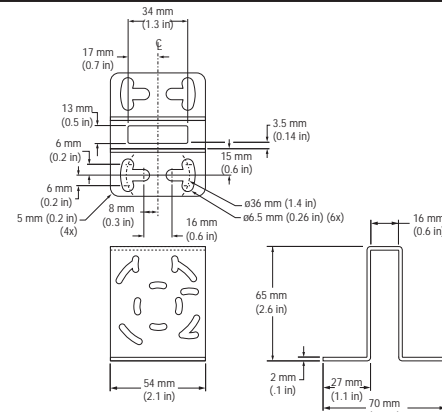
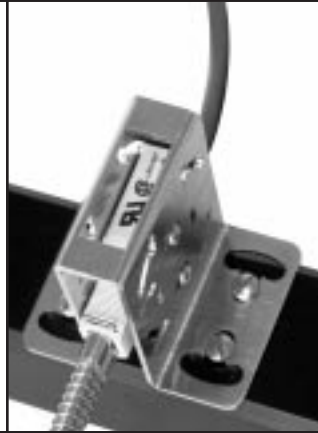
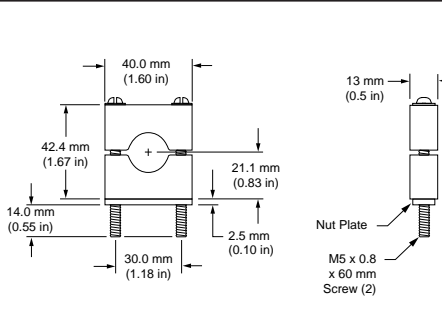
Mounting Brackets

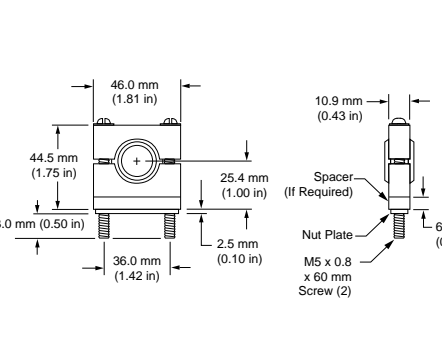
Model	Description	Description	Image
SMB312S	Stainless steel 2-axis, side mounting bracket		
SMB312PD	Stainless steel 18 mm barrel-mounting bracket		
SMB312B	Stainless steel 2-axis, bottom mounting bracket Includes SMB12F (below)		
SMB46L	<ul style="list-style-type: none"> • "L" bracket • 14 ga 316 stainless steel 		

Mounting Brackets		
Model	Description	Dimensions
SMB46S	<ul style="list-style-type: none"> • “S” bracket • 14 ga 316 stainless steel 	 
SMB46U	<ul style="list-style-type: none"> • “U” bracket • 14 ga 316 stainless steel 	 
SMB18C	<ul style="list-style-type: none"> • 18 mm split clamp black VALOX® bracket • Stainless steel mounting hardware included 	 
SMB18S	<ul style="list-style-type: none"> • 18 mm swivel, black VALOX® bracket • Stainless steel mounting hardware included 	 



WARRANTY: Banner Engineering Corporation warrants its products to be free from defects for one year. Banner Engineering Corporation will repair or replace, free of charge, any product of its manufacture found to be defective at the time it is returned to the factory during the warranty period. This warranty does not cover damage or liability for the improper application of Banner products. This warranty is in lieu of any other warranty either expressed or implied.



WARNING These photoelectric presence sensors do NOT include the self-checking redundant circuitry necessary to allow their use in personnel safety applications. A sensor failure or malfunction can result in either an energized or a de-energized sensor output condition.

Never use these products as sensing devices for personnel protection. Their use as a safety device may create an unsafe condition which could lead to serious injury or death.

Only MINI-SCREEN®, MULTI-SCREEN®, MICRO-SCREEN™, MACHINE-GUARD™ and PERIMETER-GUARD™ Systems, and other systems so designated, are designed to meet OSHA and ANSI machine safety standards for point-of-operation guarding devices. No other Banner sensors or controls are designed to meet these standards, and they must NOT be used as sensing devices for personnel protection.

