



S18 Series Diffuse-Mode Sensors

DC self-contained sensors in 18 mm barrel housings



Features

- 18 mm thermoplastic polyester threaded barrel sensor
- Advanced self-diagnostics with separate alarm output[†]; two LEDs indicate sensor performance
- Choice of integral cable or Euro-style quick-disconnect connector
- 10 to 30V dc
- SPDT (complementary) NPN or PNP outputs (150 mA max. each)
- Rated NEMA 6P, IEC IP69K

[†] Alarm output depends on hookup; see page 3.



Models

Models	Range	Cable	Supply Voltage	Output Type	Excess Gain	Beam Pattern
					Performance based on 90% reflectance white test card	
100 mm Range						
S18SN6D S18SN6DQ	100 mm (4")	2 m (6.5') cable 4-Pin Euro QD	10-30V dc	NPN		
S18SP6D S18SP6DQ		2 m (6.5') cable 4-Pin Euro QD		PNP		
300 mm Range						
S18SN6DL S18SN6DLQ	300 mm (12")	2 m (6.5') cable 4-Pin Euro QD	10-30V dc	NPN		
S18SP6LD S18SP6DLQ		2 m (6.5') cable 4-Pin Euro QD		PNP		

* 9 m cables are available by adding suffix "W/30" to the model number of any cabled sensor (e.g., S18SN6D W/30).
A model with a QD connector requires a mating cable; see page 3.



WARNING . . . Not To Be Used for Personnel Protection



Never use this product as a sensing device for personnel protection. Doing so could lead to serious injury or death.

This product does NOT include the self-checking redundant circuitry necessary to allow its use in personnel safety applications. A sensor failure or malfunction can cause either an energized or de-energized sensor output condition. Consult your current Banner Safety Products catalog for safety products which meet OSHA, ANSI and IEC standards for personnel protection.

Overview

The S18 sensor’s size, shape, and price make them ideally suited to straightforward parts detection, conveyor control and similar applications. Sensors are available with either NPN (sinking) or PNP (sourcing) configuration (see Models on page 1); outputs are complementary. The sensor has two LED indicators: green LED is ON for “power on”; yellow LED is ON whenever the sensor sees the reflection of its own modulated light source, and flashes to indicate “low excess gain” conditions (excess gain less than 1.5x in the light condition).

Specifications

Supply Voltage and Current	10 to 30V dc (10% maximum ripple); Supply current (exclusive of load current): 25 mA
Supply Protection Circuitry	Protected against reverse polarity and transient voltages
Output Configuration	SPDT (complementary) solid-state dc switch; choose NPN (current sinking) or PNP (current sourcing) models. <i>Light operate:</i> N.O. output conducts when the sensor sees its own modulated light. <i>Dark operate:</i> N.C. output conducts when the sensor sees dark. The N.C. (normally closed) output may be wired as a normally open marginal signal alarm output, depending upon hookup to the power supply (U.S. patent 5087838).
Output Rating	150 mA maximum (each) in standard hookup. When wired for alarm output, the total load may not exceed 150 mA. Off-state leakage current: < 1 microamp at 30V dc On-state saturation voltage: < 1V at 10 mA dc; < 1.5V at 150 mA dc
Output Protection Circuitry	Protected against false pulse on power-up and continuous overload or short circuit of outputs
Output Response Time	3 milliseconds ON and OFF NOTE: 100 millisecond delay on power-up; outputs do not conduct during this time
Repeatability	750 microseconds. Repeatability and response are independent of signal strength.
Indicators	Two LEDs: Green and Yellow Green ON steady = power to sensor is ON Green flashing = output is overloaded Yellow ON steady = normally open output is conducting Yellow flashing = excess gain marginal (1-1.5x) in light condition
Construction	Housing: thermoplastic polyester Lens: acrylic
Environmental Rating	Leakproof design rated NEMA 6P (IEC IP69K)
Connections	2 m (6.5') or 9 m (30') attached cable, or 4-pin Euro-style quick-disconnect fitting
Operating Conditions	Temperature: -40° to +70°C (-40° to +158°F) Maximum relative humidity: 90% at 50°C (non-condensing)
Vibration and Mechanical Shock	All models meet Mil. Std. 202F requirements. Method 201A (Vibration; frequency 10 to 60 Hz, max., double amplitude 0.06" acceleration 10G). Method 213B conditions H&I (Shock: 75G with unit operating; 100G for non-operation)
Certifications	  

Dimensions

Cabled Models

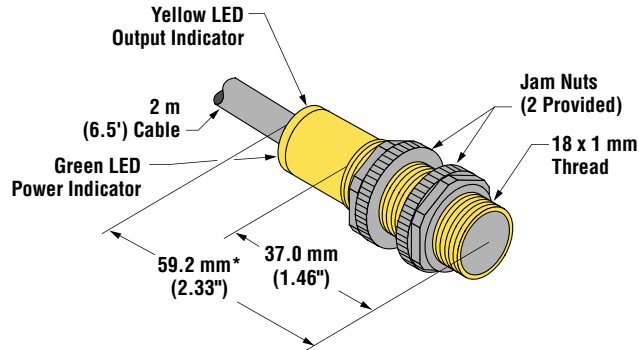

QD Models

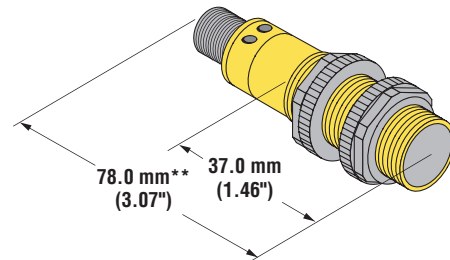

Hookups

NPN Output Models

Standard Hookup

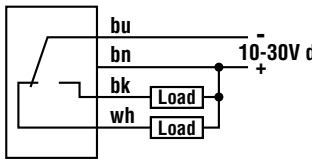

Alarm Hookup

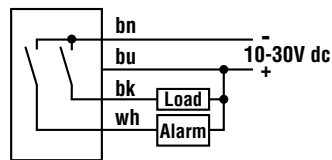

PNP Output Models

Standard Hookup

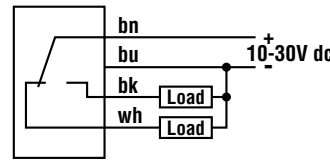

Alarm Hookup

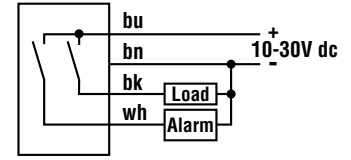

Accessories





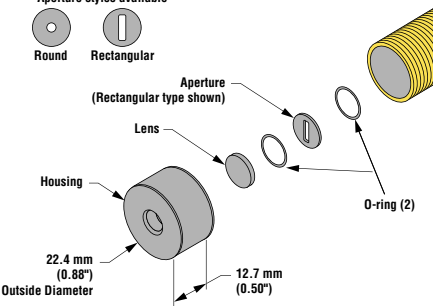
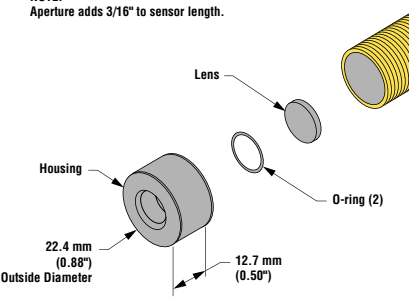

Cables

Style	Model	Length	Dimensions	Pin-out
4-Pin Euro-style Straight	MQDC-406 MQDC-415 MQDC-430	2 m (6.5') 5 m (15') 9 m (30')		
4-Pin Euro-style Right-angle	MQDC-406RA MQDC-415RA MQDC-430RA	2 m (6.5') 5 m (15') 9 m (30')		

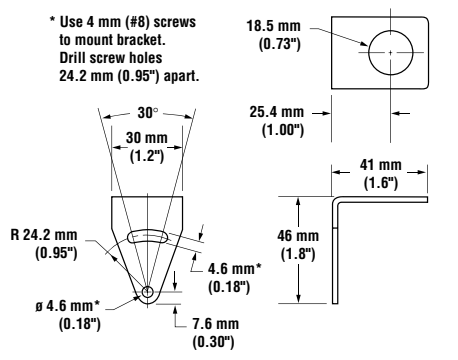
Apertures

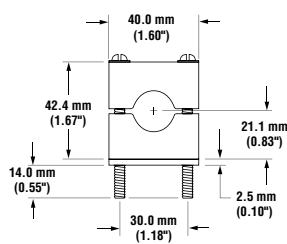
<p>AP18SC kit includes round apertures: 0.5 mm (0.02") dia. 1.0 mm (0.04") dia. 2.5 mm (0.10") dia.</p>	<p>NOTE: Aperture adds 3/16" to sensor length Aperture styles available</p> <p>Round Rectangular</p> <p>Aperture (Rectangular type shown)</p> <p>Lens</p> <p>Housing</p> <p>22.4 mm (0.88") Outside Diameter</p> <p>12.7 mm (0.50")</p> <p>O-ring (2)</p> 	<p>APG18S kit includes glass lens (window) to protect plastic sensor lens from chemical environments</p>	<p>NOTE: Aperture adds 3/16" to sensor length.</p> <p>Lens</p> <p>Housing</p> <p>22.4 mm (0.88") Outside Diameter</p> <p>12.7 mm (0.50")</p> <p>O-ring (2)</p> 
<p>AP18SR kit includes rectangular apertures: 0.5 mm (0.02") wide 1.0 mm (0.04") wide 2.5 mm (0.10") wide</p>			

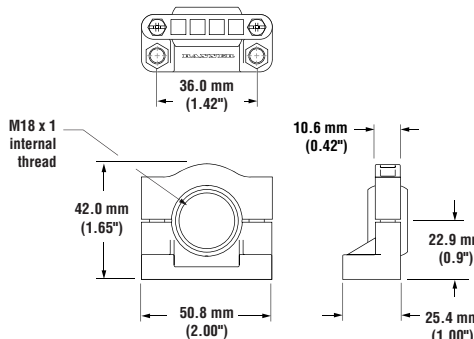
Mounting Brackets

<p>SMB18A</p>	<ul style="list-style-type: none"> • 12-gauge stainless steel right-angle bracket • Curved mounting slot • Clearance for M4 (#8) hardware 	<p>SMB18C</p>	<ul style="list-style-type: none"> • 18 mm split clamp bracket • Black thermoplastic polyester • Includes stainless steel mounting hardware
<p>* Use 4 mm (#8) screws to mount bracket. Drill screw holes 24.2 mm (0.95") apart.</p>  		  <p>Nut Plate</p> <p>M5 x 0.8 x 60 mm Screw (2)</p>	
<p>SMB18SF</p>	<ul style="list-style-type: none"> • 18 mm swivel bracket • Black thermoplastic polyester • Includes stainless steel mounting hardware 	 <p>BANNER[®]</p> <p>more sensors, more solutions</p>	
 <p>M18 x 1 internal thread</p> 	<div style="border: 1px solid black; padding: 10px;"> <p>WARRANTY: Banner Engineering Corp. warrants its products to be free from defects for one year. Banner Engineering Corp. will repair or replace, free of charge, any product of its manufacture found to be defective at the time it is returned to the factory during the warranty period. This warranty does not cover damage or liability for the improper application of Banner products. This warranty is in lieu of any other warranty either expressed or implied.</p> </div>		