



1 5/8" Channel

Telestrut

Nuts & Hardware

General Fittings

Pipe/Conduit Supports

Electrical Fittings

Concrete Inserts

Solar

Unipier®

P1383 EG, GR, HG

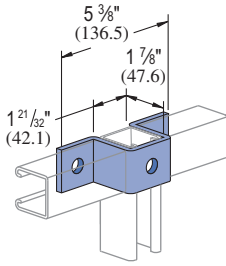

Wt/100 pcs: 95 Lbs (43.1 kg)

P1732 EG, GR, HG

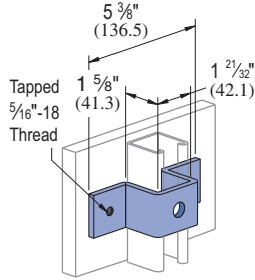

Wt/100 pcs: 88 Lbs (39.9 kg)

P2237 EG, GR, HG

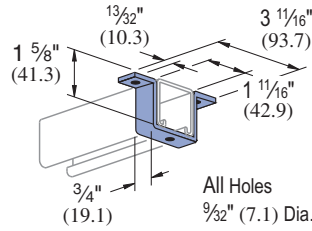

Material: 1/8" (3.2) thick.

Wt/100 pcs: 18 Lbs (8.2 kg)

P5543 EG, GR, HG

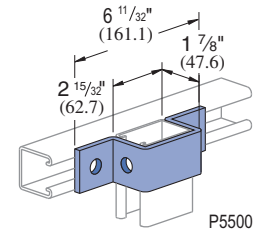

P5500

Wt/100 pcs: 97 Lbs (44.0 kg)

P1048, P1049, P1050

EG, GR, HG

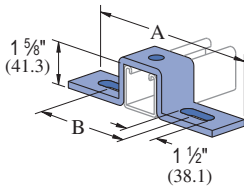

Part Number	"A" In (mm)	"B" In (mm)	Wt/100 pcs Lbs (kg)
P1048	7 1/4 184.2	4 1/8 104.8	105 47.6
P1049	8 1/2 215.9	5 3/8 136.5	120 54.4
P1050	10 3/8 263.5	7 1/4 184.2	130 59.0

P1043A EG, GR, HG

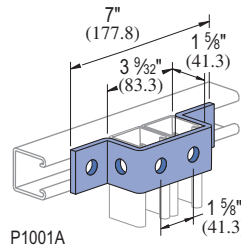

P1001A

Wt/100 pcs: 105 Lbs (47.6 kg)

P1737 EG, GR, HG

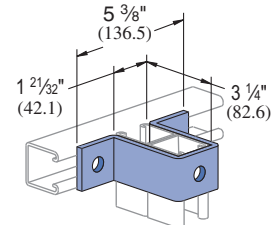

P1001 (shown), P1101, P2001, P4004 or P5000

Wt/100 pcs: 128 Lbs (58.1 kg)

P2473 EG, GR, HG

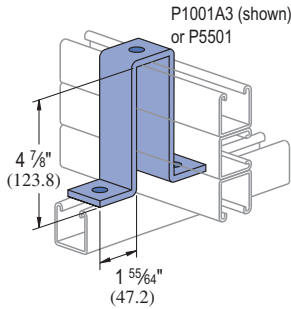

Wt/100 pcs: 197 Lbs (89.4 kg)

P4043 EG, GR, HG

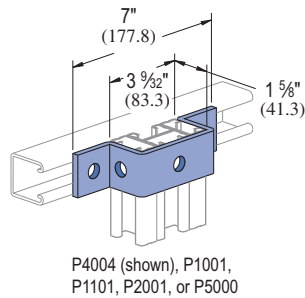

Wt/100 pcs: 106 Lbs (48.1 kg)

P1044 EG, GR, HG

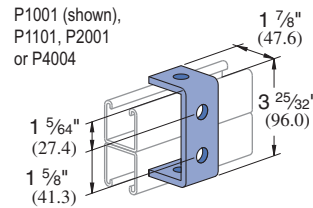

Wt/100 pcs: 70 Lbs (31.8 kg)

P1973 EG, GR, HG

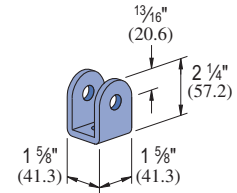

Wt/100 pcs: 53 Lbs (24.0 kg)

P2326 EG, GR, HG

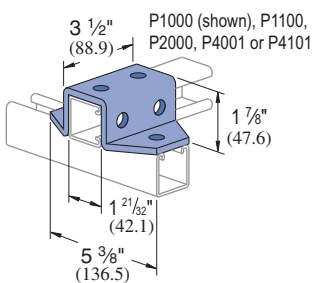

Wt/100 pcs: 171 Lbs (77.6 kg)

P2328

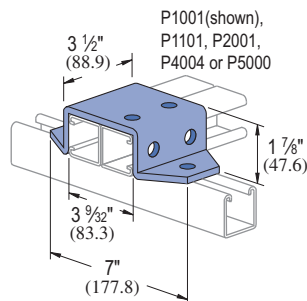

Wt/100 pcs: 209 Lbs (94.8 kg)

P2329

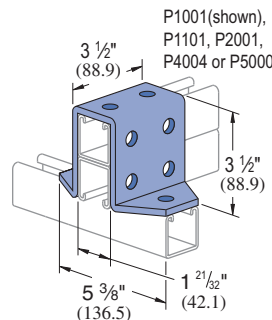

Wt/100 pcs: 257 Lbs (116.6 kg)

P1046A EG, GR, HG

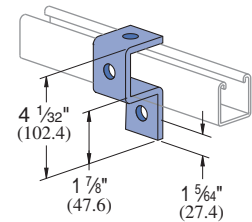

Wt/100 pcs: 76 Lbs (34.5 kg)

Standard Dimensions for 1 5/8" (41.3mm) width series channel fittings (Unless Otherwise Shown on Drawing)

Hole Diameter: 9/16" (14.3mm); Hole Spacing - From End: 13/16" (20.6mm); Hole Spacing - On Center: 1 7/8" (47.6mm); Width: 1 5/8" (41.3mm); Thickness: 1/8" (6.4mm)