





FS and FD Two Gang Cast Device Boxes

UNILETS® for use with Threaded Rigid Metal Conduit and IMC. Furnished with Internal Ground Screw.

FS Box (Shallow) 2.00" deep, FD Box (Deep) 2.69" deep

	Type	Depth	Hub Size (Inches)	Catalog Number	
				Malleable Iron Ridge Top	Aluminum Ridge Top
	FS	Shallow	1/2	FS-2-50	FS-2-50-A
			3/4	FS-2-75	FS-2-75-A
			1	FS-2-100	—
	FD	Deep	1/2	FD-2-50	—
			3/4	FD-2-75	FD-2-75-A
			1	FD-2-100	—
	FSC	Shallow	1/2	FSC-2-50	—
			3/4	FSC-2-75	—
			1	FSC-2-100	—
	FDC	Deep	1/2	FDC-2-50	—
			3/4	FDC-2-75	FDC-2-75-A
			1	FDC-2-100	—
	FSS	Shallow	1/2	FSS-2-50	—
			3/4	FSS-2-75	FSS-2-75-A
			1	FSS-2-100	—
	FDS	Deep	3/4	FDS-2-75	—
					—
					—
	FSD	Shallow †	1/2-3/4	FSD-2-75	—
	FS	1" Extension *	—	FS-2EXT	—











† Largest hub at bottom in illustration.

* Extension does not have a ground screw.

Fittings

FITTINGS: CAST DEVICE BOXES

FS and FD Two Gang Cast Hub Device Box Covers for Ridge Top Boxes

	Description	Catalog Number	
		Steel	Aluminum
Stamped Steel and Aluminum Covers — With stainless steel screws, less gasket			
	For square handle tumbler or toggle flush switches	FSK-2TS	FSK-2TS-A
	For two round receptacles. Mounts on device. Hole Dia. – 1-13/32"	FSK-2R-Q	—
	For two round receptacles. Mounts directly on box. Hole Dia. – 1-13/32"	FSK-2R-W	—
	For round flush receptacles, with lift cover. Mounts on device. Hole Dia. – 1-13/32"	FSK-2R-T	—
	For duplex flush receptacles	FSK-2DR	FSK-2DR-A
	For tumbler flush switch and duplex flush receptacles	FSK-2RS-K	—
	For round flush receptacle and duplex receptacles Hole Dia. – 1-13/32"	FSK-2R-L	—
	For round receptacles. Hole Dia. – 2-15/32	FSK-2R-M	—
	Blank Cover	FSK-2B	FSK-2B-A
		Malleable Iron	Aluminum
Cast Covers — Weatherproof — With gasket and stainless steel screws			
	For external operation of tumbler switches with square handles	FSK-2VTS	FSK-2VTS-A
	Blank Cover	FSK-2B-CM	FSK-2B-CA
	Gasket — Replacement Neoprene — for use with 2-gang cast covers above	FS-GKR-2N	—

Fittings

FITTINGS: CAST DEVICE BOXES

FS and FD Two Gang and Cast Hub Device Box Wiring Capacity and Dimensions

Wiring Capacity

Hub Size (inches)	Capacity (in ³ /dm ³)	
	FS	FD
1/2	32.00/0.52	45.00/0.74
3/4	32.00/0.52	45.00/0.74
1	32.00/0.52	45.00/0.74

Dimensions

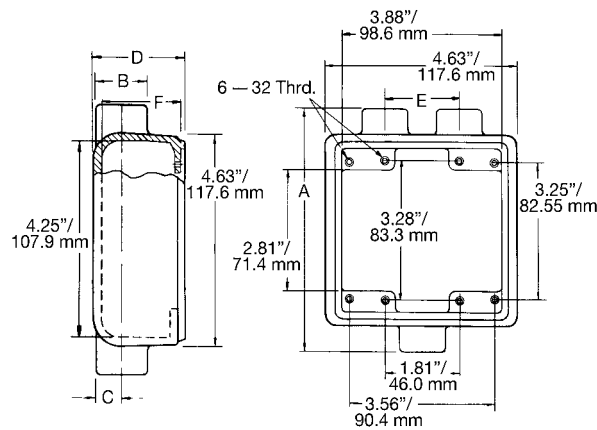

Hub Size (inches)	Dimensions in Inches/Millimeters							
	A	B	C	D		E	F	
				"FS"	"FD"		"FS"	"FD"
1/2	5.88/149.4	1.13/28.7	0.63/16.0	2.00/50.8	2.69/68.3	1.88/47.8	1.78/45.2	2.44/62.0
3/4	5.88/149.4	1.38/35.1	0.75/19.1	2.00/50.8	2.69/68.3	1.88/47.8	1.78/45.2	2.44/62.0
1	6.31/160.3	1.69/42.9	0.94/23.9	2.00/50.8	2.69/68.3	2.06/52.3	1.78/45.2	2.44/62.0

Fittings

FITTINGS: CAST DEVICE BOXES