

NEMA Pressure and Temperature Controls

Bulletin	836T	837
Features	<ul style="list-style-type: none"> Independently adjustable trip and reset settings Heavy-duty bellows or piston-style actuator High reliability, snap-action silver contacts On-machine style enclosure with removable access cover 	<ul style="list-style-type: none"> Independently adjustable trip and reset settings Heavy-duty bellows-type actuator High reliability, snap-action silver contacts Direct immersion or remote bulb and capillary sensing elements
Operating Range	30 in. Hg vacuum to 5000 psi	-60...+570 °F (-51.1...298.9 °C)
Differential	Independently adjustable	Independently adjustable
Repeat Accuracy	<ul style="list-style-type: none"> Bellows (+/-1%) Piston without seal (+/-3%) Piston with seal (+/-5%) 	+/- 2 °F (+/- 16.7 °C)
Maximum Operating Limit	up to 15 000 psi	up to 600 °F (315.6 °C)
Actuator Type	<ul style="list-style-type: none"> Style T – Bellows and Piston types available 	<ul style="list-style-type: none"> Style A/H/V – Bellows
Enclosure Options	Type 1/4/13, 7 & 9 and 4 & 13	Open, Type 1, 4 & 13, 7 & 9 and 4 & 13
Ambient Operating Temperature	-22...+150 °F (-30...+66 °C)	-22...+150 °F (-30...+66 °C)
Ambient Storage Temperature	-22...+200 °F (-30...+93 °C)	-22...+200 °F (-30...+93 °C)
Contact Ratings (Std.)	<ul style="list-style-type: none"> 2 Circuit – NEMA A600 4 Circuit – NEMA B150 	<ul style="list-style-type: none"> Non-Inductive – 5 A, 240V / 3 A, 600V Control Circuit – AC-125 VA, 24...600V DC-57.5 VA, 115...230V
Accessories/Modifications	Pulsation Snubbers, Pilot Light Indicators, Quick Connects	Custom Capillary Lengths & Materials, Pilot Light Indicators, Quick Connects
Certifications	<ul style="list-style-type: none"> UL & CSA (Standard Application and Haz Loc) CE (Standard Application) 	<ul style="list-style-type: none"> UL & CSA (Standard Application and Haz Loc) CE (Standard Application)
Product Selection	Page 13-34	Page 13-48

Bulletin 803 Rotating Cam Limit Switches — Renewal Parts



Bulletin 803 Style F

Contact Blocks

The following are the contact blocks offered for the Bulletin 803 Style A, B, and F.

Contact Blocks for Style A, B, and F	
Description	Cat. No.
Style A Contact Block	WX110280
Style B Contact Block	WX265557
Style F Contact Block	WX286260

Cam Kits

The following are the cam kits offered for the Bulletin 803 Style P.

Cams for Style P			
Cam Code Designator	Adjustable Degrees of Dwell		Cam Kit*
	N.C. Contact Opens	N.O. Contact Remains Closed	Cat. No.
3	27...33°	327...333°	803-NK33
4	33...39°	321...327°	803-NK34
5	38...49°	311...322°	803-NK35
6	48...69°	291...312°	803-NK36
7	68...109°	251...292°	803-NK37
8	108...189°	171...252°	803-NK38
9	148...269°	91...212°	803-NK39
0	188...349°	11...172°	803-NK40

* Kit includes two cam and mounting hardware for one circuit.



Bulletin 836T — Pressure Controls, Traditional Machine Tool

- Operating ranges from 30 in. Hg vacuum...5000 psi
- Independently adjustable range and differential
- Copper alloy and stainless steel bellows
- 2- and 4-Circuit contact block
- Pressure difference controls available
- 1/4 in. and 3/8 in. N.P.T. and O-ring straight thread connections
- Type 4 & 13 and Type 7 & 9 and 4 & 13 combination enclosures

Table of Contents

- Product Overview this page
- Technical Data 13-25
- Product Selection 13-33
- Modifications 13-40
- Accessories 13-41
- Conversion Kits 13-42
- Factory Options 13-43
- Wiring Diagrams 13-44
- Approximate Dimensions 13-47

Standards Compliance

(For file and guide numbers, see the table below)

Certifications



File and Guide Numbers

Bulletin 836T	UL		CSA	
	File Number	Guide Number	File Number	Class
	E14842	NKPZ	LR1234	3211-03
	E53048 (Haz. Loc.)	NOWT	LR11924 (Haz. Loc.)	3218-05
Hazardous Location Enclosure not CE compliant. All other enclosed devices are CE compliant				

Product Overview

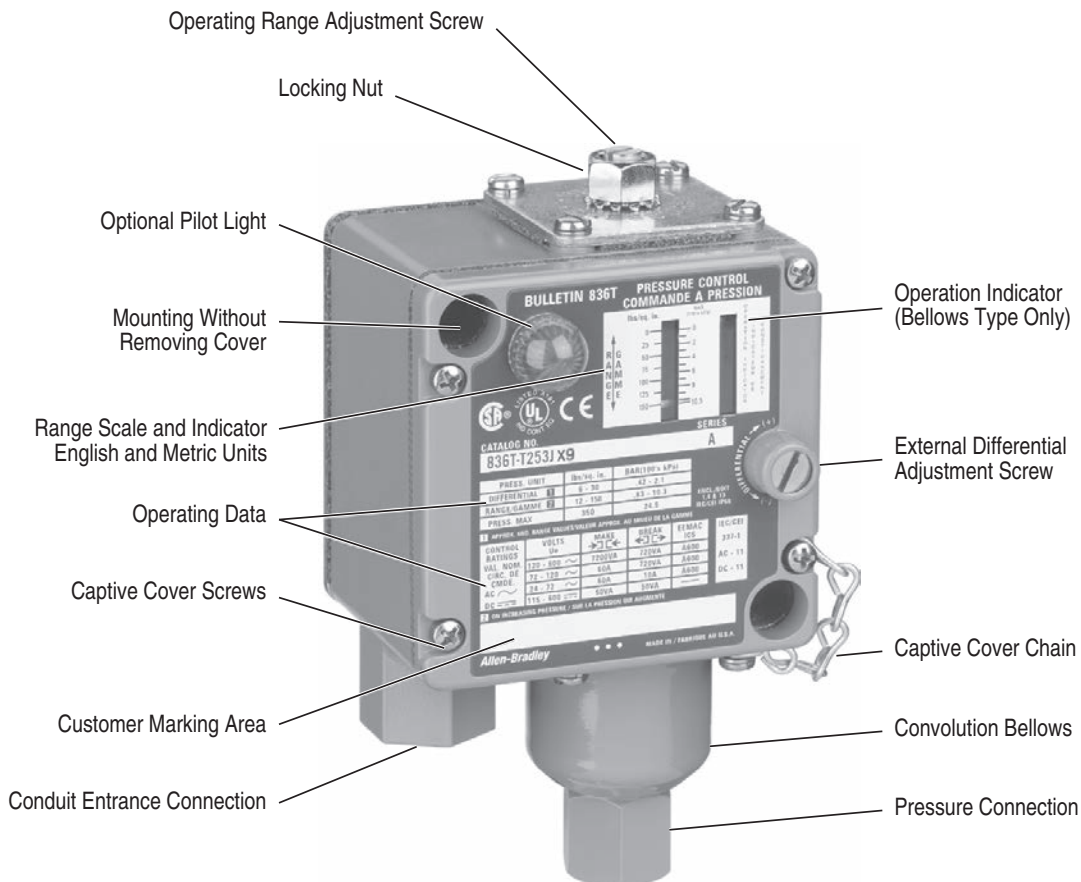

Description

Bulletin 836T Pressure Controls are control circuit devices designed to meet the traditional requirements of the transportation, machine tool, and other heavy-duty industries. Allen-Bradley Bulletin 836T Pressure Controls can be used in pneumatic and hydraulic applications. The copper alloy bellows actuators can be used with air, water, oil, vapor, and other non-corrosive gases and liquids. Type 316 stainless steel bellows are available for more corrosive gases, vapors, and fluids.

A rugged stainless steel cylinder and stainless steel piston assembly is used for the higher-pressure coolant and hydraulic oil applications. May also be used with water and water-based fluids. The controls feature snap-action precision switches equipped with silver contacts. A relatively friction-free mechanism provides consistent operation regardless of mounting position. Devices are designed to allow easy adjustment of pressure settings.

Allen-Bradley Bulletin 836T Pressure Controls are used in many types of applications with adjustable ranges from 30 in. Hg vacuum...5000 psi. They can be used to control pneumatic systems and maintain a pressure tank within a preset and constant pressure range. They can be used to detect over-pressures of gases and liquids to prevent damage to valuable equipment. Pressure controls can also detect low pressure to protect equipment from loss of coolants and lubrication.

Bulletin 836T Pressure Controls are offered in a variety of styles to fit a wide range of applications. The devices are available with either a Type 1, 4 & 13, or 7 & 9 and 4 & 13 combined enclosure. They are available with two-circuit or four-circuit contact blocks. Accessories and modifications are available to tailor the devices to meet most application requirements.

Style T — Pressure Control



Style T

- Independently adjustable operating range and differential
- Single bellows or piston operation

Copper Alloy Bellows

- 1/4 in. N.P.T. female pipe connection
- Adjustable operating range — 30 in. Hg vacuum...650 psi
- Maximum line pressure — up to 1300 psi
- Occasional surge pressure — up to 1600 psi

Type 316 Stainless Steel Bellows

- 1/4 in. N.P.T. female pipe connection
- Adjustable operating range — 30 in. Hg vacuum...375 psi
- Maximum line pressure — up to 600 psi
- Occasional surge pressure — up to 600 psi

Piston

- 3/8 in. N.P.T. female pipe connection
- SAE 7/16-20 UNF-2B thread O-ring boss seal
- SAE 9/16-18 UNF-2B thread O-ring boss seal
- Adjustable operating range — 40...5000 psi
- Occasional surge pressure — up to 15,000 psi

Applications

- Machine tools
- Machine hydraulic pressures
- Material clamping fixtures
- Lubricant and coolant pressures
- Compactor ram pressures
- Air compressors

Style D — Pressure Difference Control



Style D

- Independently adjustable system difference range and differential
- Two-bellows operation, one bellows connected to each system

Copper Alloy Bellows

- 1/4 in. N.P.T. female pipe connection
- Adjustable system difference range — 1...70 psi
- Maximum line pressure — up to 600 psi
- Occasional surge pressure — up to 650 psi

Type 316 Stainless Steel Bellows

- 1/4 in. N.P.T. female pipe connection
- Adjustable system difference range — 1...70 psi
- Maximum line pressure — up to 500 psi
- Occasional surge pressure — up to 500 psi

Technical Terms

Adjustable operating range — Total span within which the contacts can be adjusted to trip and reset.

Trip setting — Higher pressure setting at which value the contacts transfer from their normal state to a change state.

Reset setting — Lower pressure setting at which value the contacts return to their normal state.

Adjustable differential — Difference between the trip and reset values

Minimum differential — When the differential is set to the lowest possible difference between trip and reset.

Maximum differential — When the differential is set to the highest possible difference between trip and reset.

Max. occasional surge pressure — Maximum surge pressure that can be applied to the actuator. Surges or ransients can occur during start-up and shut-down of a machine or system. Expressed in milliseconds, complex electronic instrumentation is required to measure the varying amplitude, frequency, and duration of this wave form. Extreme surges that occur approximately 8 times in a 24-hour period are negligible.

Maximum line pressure — Maximum sustained pressure that can be applied to the actuator without permanent damage. The control should not be cycled at this pressure. **Note:** Does not apply to piston type controls.

psi — Pounds per square inch gauge (positive pressure). Devices listed are in gauge pressure units which use atmospheric pressure as a reference. Atmospheric pressure at sea level is approximately 14.7 psi or 30 in. Hg.

Vacuum — Inches of mercury (in. Hg) vacuum (negative pressure).

Operating range adjustment screw — This screw is used to adjust the trip setting by varying the force of the main spring.

Differential adjustment screw — This screw is used to adjust reset setting by varying the force of the differential blade spring.

Pressure media — There are many types of pressure media that can be controlled. Examples include air, water, hydraulic fluids, and other types of gases and liquids. The type of media and the maximum system pressure will determine the type of actuator used for the pressure control application. See page 13-32.

Pressure connection — Common standard types of pressure connections used in control systems are 1/4 in. and 3/8 in. N.P.T. female pipe threads. SAE 7/16 and SAE 9/16 O-ring boss seals are also available (piston versions only).

Contact configuration — Bulletin 836T controls are available with either a 2-circuit or 4-circuit contact block. See Contacts.

Style D

Style D — pressure difference controls adjustable system difference range — The adjustable operating range for a pressure difference control.

System difference pressure bushing — This bushing is used to adjust the trip setting by varying the force on the main spring.

Trip setting — Desired difference in pressure between the two bellows at which value the contacts transfer from their normal state to a changed state. This occurs in one of the following conditions:

- The pressure in the bottom bellows is higher than the pressure in the top bellows by a value equal to the trip setting.
- The pressure in the bottom bellows remains constant and the pressure in the top bellows decreases by a value equal to the trip setting.

Reset setting — Predetermined normal difference in pressure between the two bellows, at which value the contacts return to their normal state. This occurs in one of the following conditions:

- The pressure in the bottom bellows is lower than the top bellows.
- The pressure in the bottom bellows remains constant and the pressure in the top bellows increases.

Figure 1
 Graphics to illustrate technical terms

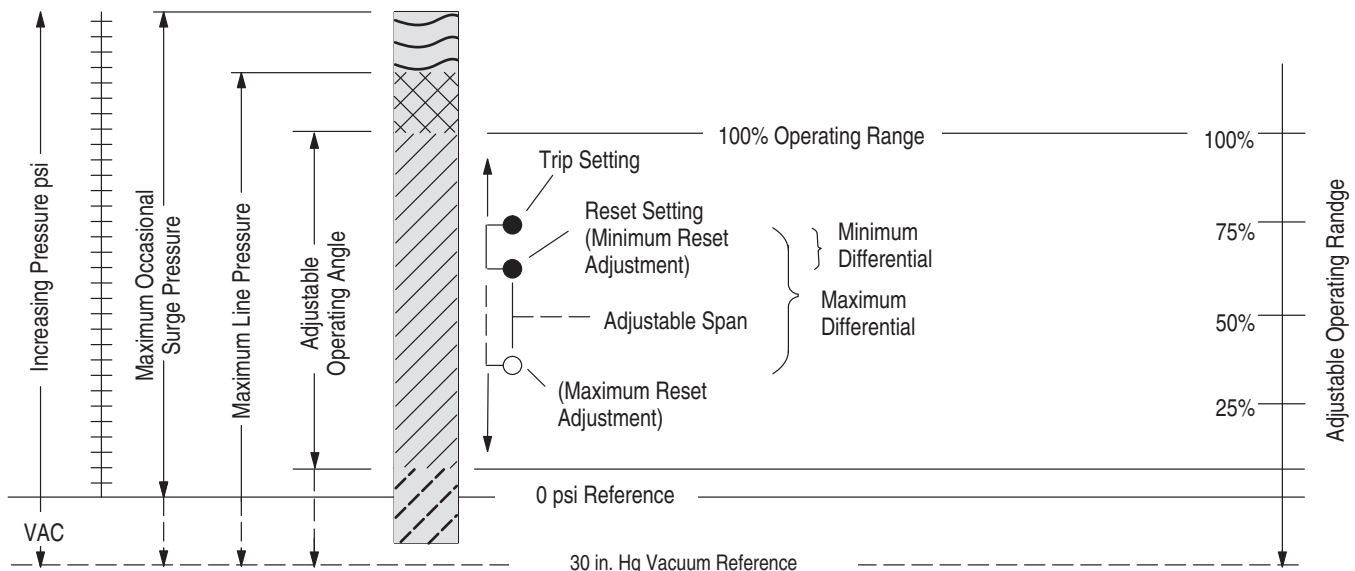

Theory of Operation

Bulletin 836T Pressure Controls are designed to open or close electrical circuits in response to changes in pneumatic (air or gas) or hydraulic (oil or non-corrosive liquids) pressure. Piston controls are not intended for use with air or water. Figure 2 shows the basic operating mechanism.

Pressure is applied to the actuator which can be either a bellows or piston type. As pressure rises, the actuator exerts force on the main spring. When the threshold force of the main spring is overcome, levers transfer the motion to the contact block, displacing the contacts — this is referred to as the trip setting. The unique lever design amplifies the actuator motion, providing shorter stroke, which results in maximizing bellows life.

The lever assembly also includes a virtually friction-free over-center toggle arrangement, providing positive snap action to the contact block for long contact life. As pressure falls, force on the differential spring increases and contacts return to their normal state — this is referred to as reset setting. Varying the force of the main spring (by turning the operating range adjustment screw) determines when the contacts will trip. Varying the force of the differential spring (by turning the differential adjustment screw) determines when the contacts will reset. Setting trip and reset values determines the operating parameters of the application.

Figure 2
 Basic mechanical structure

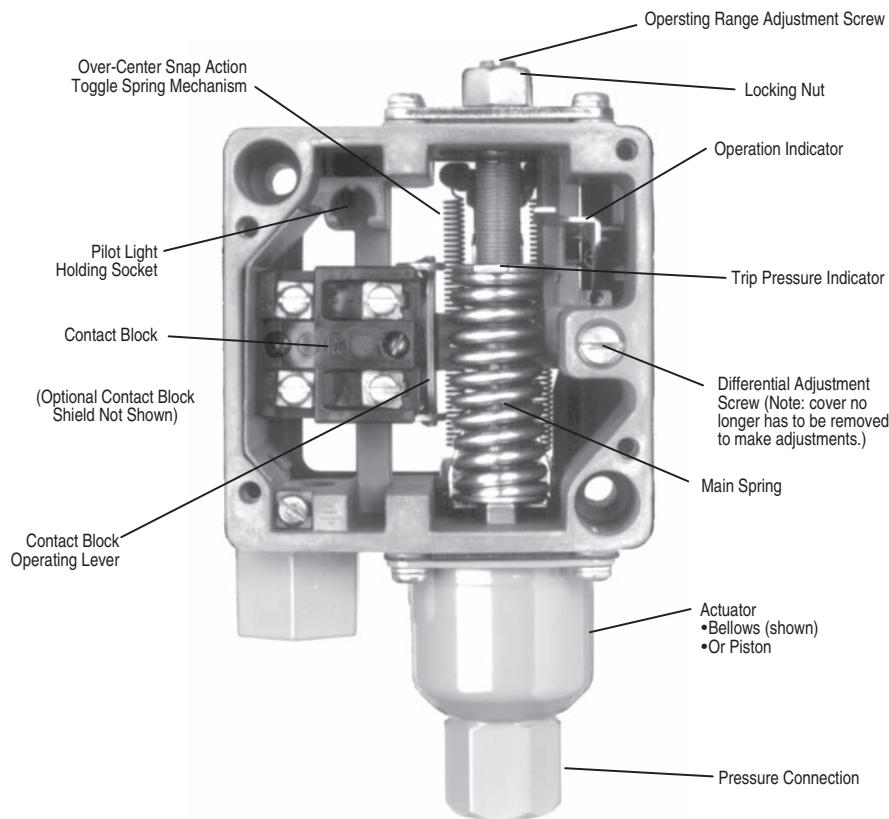

Applications for Control

Pressure controls can be used to either control or monitor a machine or process. Figure 3 shows a typical control application. Here, pressure is controlled within predetermined high and low values. Figure 4 shows a typical monitoring application. Here, pressure is monitored between a high and low value, signaling when a preset limit has been exceeded.

Figure 3
 Typical control application

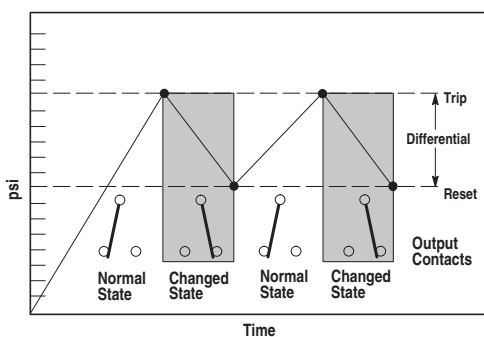
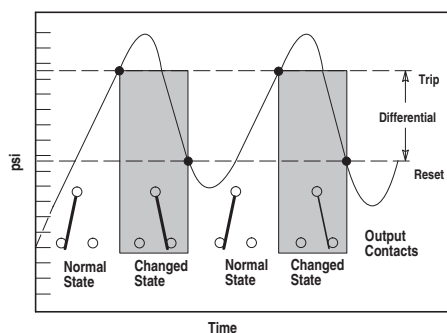

Figure 4
 Typical monitoring application



Control Setting — Style T Pressure Controls

Allen-Bradley controls are designed for ease of setting to help minimize installation time. Standard pressure controls shipped from the factory are set at the maximum operating range and minimum differential. By using a pressure gauge and following these simple directions, the control can be set to the specific requirements for each application. See Figure 5.

Step 1 — Adjust trip setting

The trip setting is controlled by the operating range adjustment screw and is adjusted externally. After loosening the lock nut, the trip setting is set by turning the operating range adjustment screw counterclockwise to lower the trip setting or clockwise to raise the trip setting. The approximate trip setting is shown on the indicating scale. When the proper setting is reached, simply tighten the lock nut.

Note: Turning the operating range adjustment screw will cause both the trip and reset settings to change in virtually equal increments.

Step 2 — Adjust reset setting

The reset setting is controlled by an external differential adjustment screw. The reset setting is set by turning the differential adjustment screw clockwise to increase the differential or counterclockwise to decrease the differential.

Note: Adjusting the differential has little or no effect on the trip setting.

Figure 5
Trip and reset adjustment for pressure controls

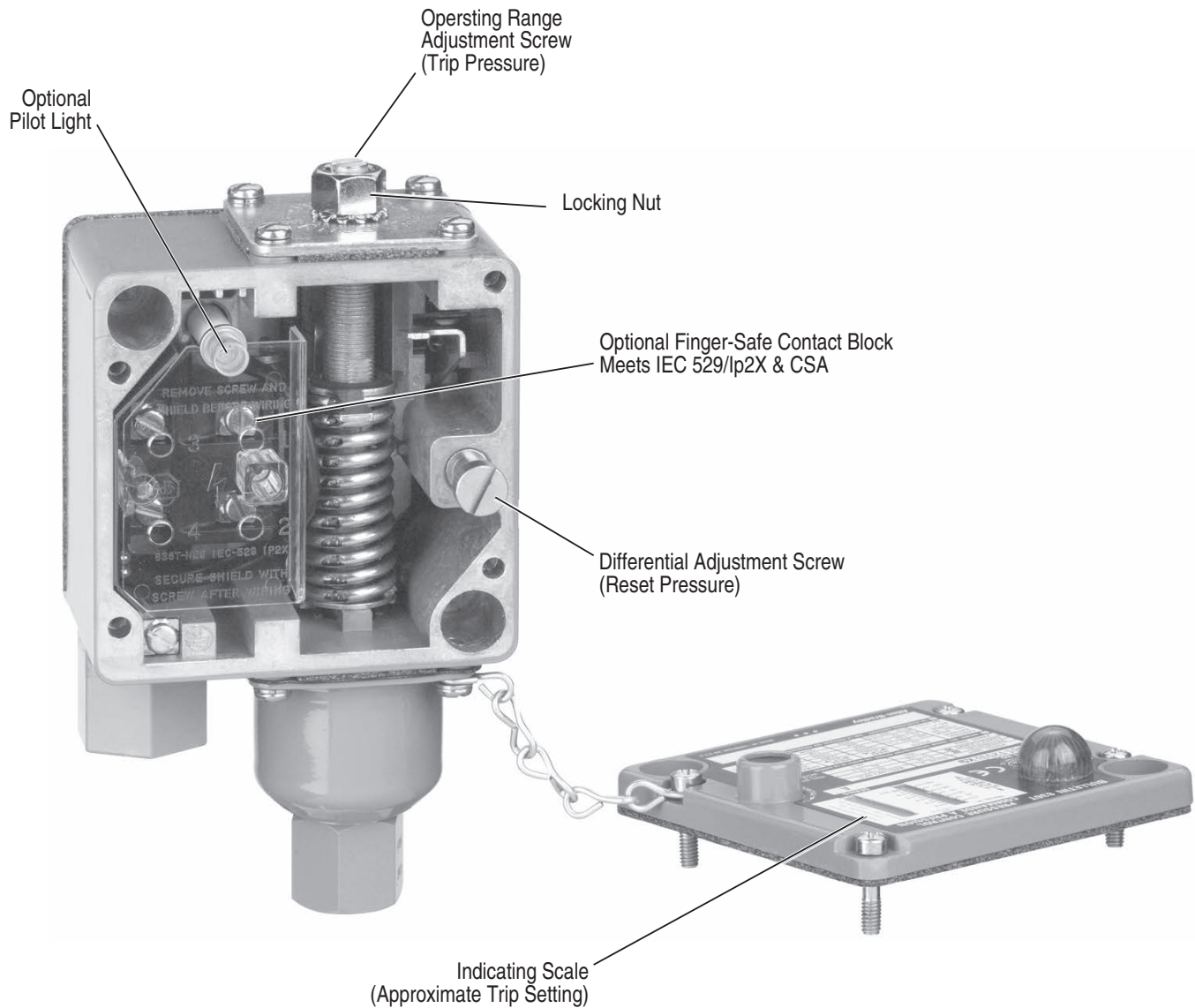

Control Setting — Style D Pressure Difference Controls

Standard pressure difference controls shipped from the factory are set at the maximum adjustable difference range and minimum differential. Remove the front cover and use a pressure gauge to make the following adjustments. See Figure 6.

Step 1 — Adjust trip setting (difference pressure)

The trip setting is controlled by the system difference pressure bushing and is adjusted internally. With no pressure (open to atmosphere) applied to top bellows, apply a constant pressure to bottom bellows equal to the desired difference in pressure at which the contacts are to trip. Insert a 1/8 in. diameter rod into a hole in the bushing and turn bushing to the left. Continue to turn bushing until the mechanism trips; circuit 1-2 will open. At this value, the trip setting is set at the pressure which is being applied to the bottom bellows.

Note: Turning the system difference pressure bushing will cause both the trip and reset settings to change in virtually equal increments.

Step 2 — Adjust reset setting (differential pressure)

The reset setting is controlled by differential adjustment screw (this adjustment can be made with the cover on). The reset setting is adjusted by turning the differential adjustment screw clockwise to increase the differential or counterclockwise to decrease the differential.

Note: Adjusting the differential has little or no affect upon the trip setting (difference pressure).

Figure 6
 Trip and reset adjustment for pressure difference controls — 4-circuit contact block

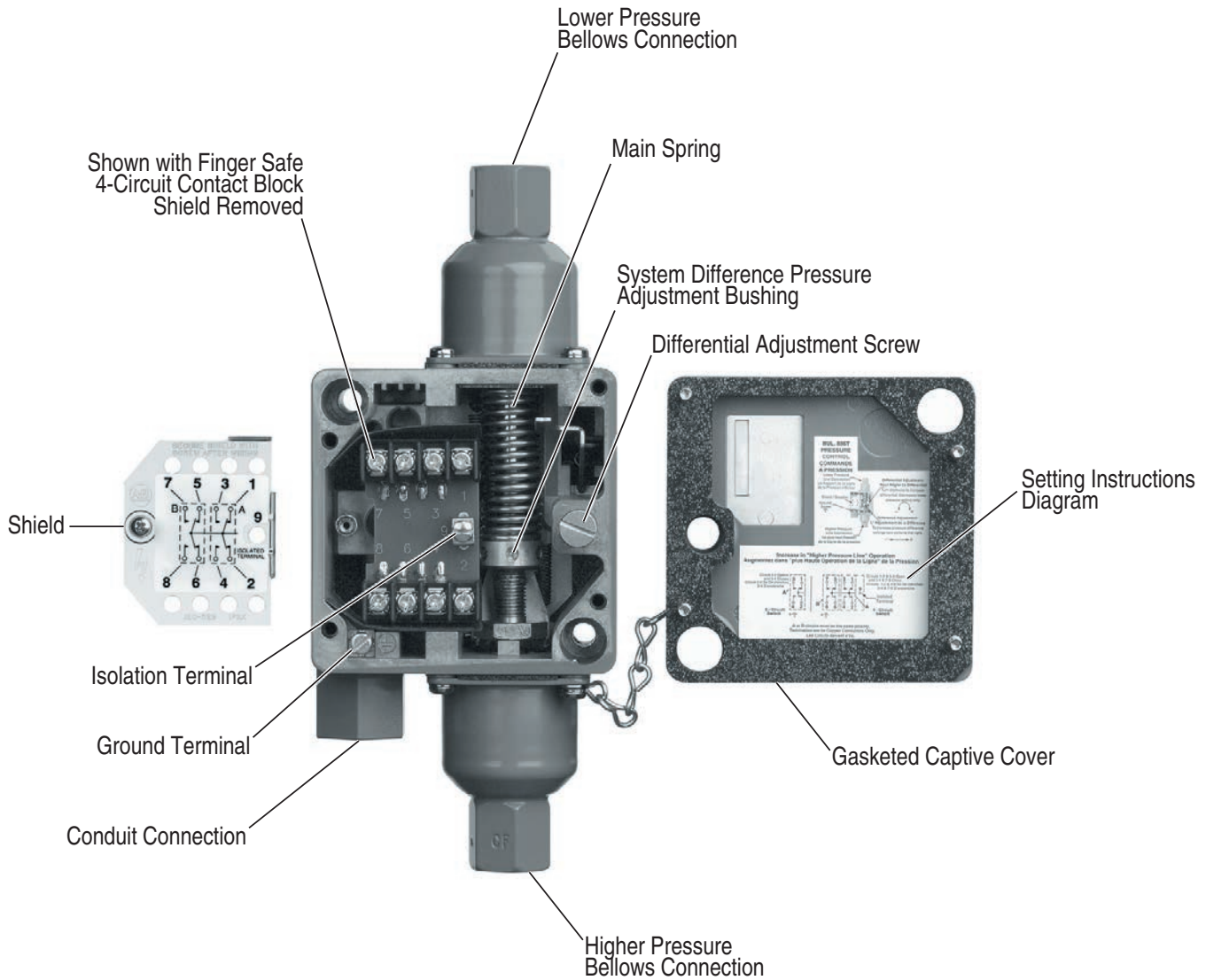

Repeat Accuracy and Mechanical Life

The design and construction of Bulletin 836T Pressure Controls provide a typical repeat accuracy equal to or better than the values shown in the repeat accuracy table below. Repeat accuracy is based on percent of maximum range, evaluated from test data and calculated using the formula per ICS 2-225 standards. Repeat accuracy and mechanical life of bellows type controls is graphically illustrated in Figure 7. The life curve does not apply to piston type controls.

For general applications, controls selected where the contacts operate between 30% and 80% of the operating range and where the maximum line and surge pressures do not exceed the specified values will provide excellent life and repeat accuracy. For more specific applications, it is important to note that the controls are designed to operate below or above these values. However, there may be a small trade-off between the factors of repeat accuracy and mechanical life.

Figure 7
 Repeat accuracy versus mechanical life graph

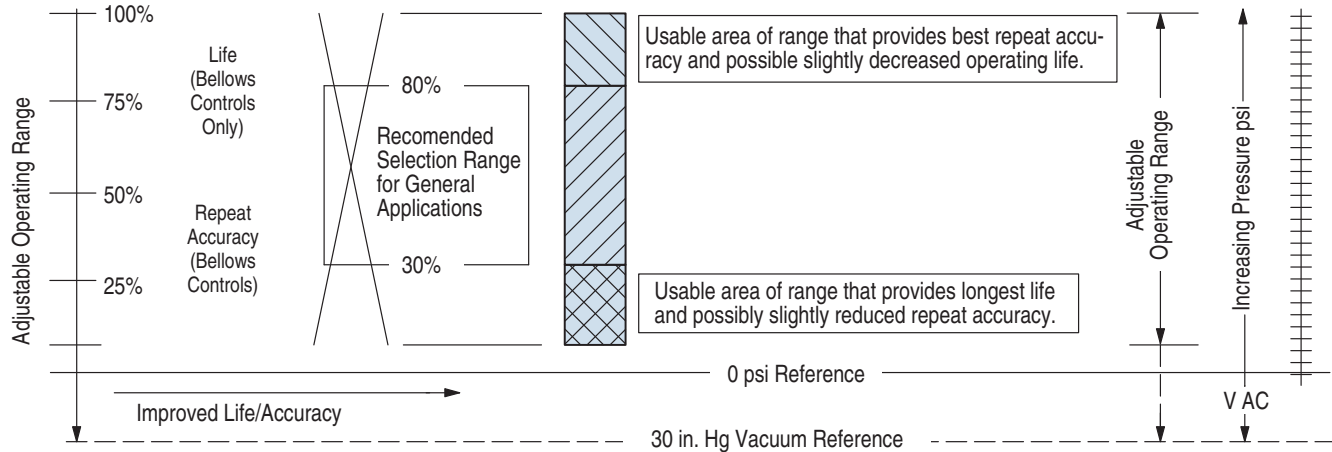

Repeat Accuracy

Type	Typical Characteristics (% of Maximum Range) *
Bellows	± 1%
Piston with seal	± 5% *
Piston without seal	± 3%

* Evaluation made from test data and calculated using formula per ICS 2-225 standards.

* Seal adds additional friction and value shown takes into consideration initial breakaway frictional force incurred during start-up or infrequent cycle operation. On continual cycle operation the repeat accuracy approaches ±3%.

Conversion Factors (Rounded)

psi x 703.1 = mm/H₂O
 psi x 27.68 = in. H₂O
 psi x 51.71 = mm/Hg
 psi x 2.036 = in. Hg
 psi x 0.0703 = kg/cm²
 psi x 0.0689 = bar
 psi x 68.95 = mbar
 psi x 6895 = Pa
 psi x 6.895 = kPa

Note:

psi - pounds per square inch (gauge).
 H₂O at 39.2 °F
 Hg at 32 °F

Mounting without Removing Cover

Bulletin 836T controls can be mounted without removing the front cover. This helps prevent foreign materials from entering the opened enclosure during the interval between mounting and wiring of the control.

Factory Set Pressure Controls

Rockwell Automation will factory set pressure controls to customer specified values. Unspecified pressure controls shipped from the factory are set at the maximum operating range and minimum differential. See Factory-Set Pressure Controls, page 13-43.

Temperature Range

The temperature range at +32 °F (0 °C) or below is based on the absence of freezing moisture, water, or other fluids that may solidify and impede the operation of the control. Temperature ratings:

Operating: -22... +150 °F
 (-30...+66 °C)

Storage: -22...+200 °F
 (-30...+93 °C)

Contacts

Bulletin 836T controls feature 2- and 4-circuit contact blocks for added control circuit flexibility. Two-circuit contact blocks have one normally open contact and one normally closed contact and may be arranged for single-pole double-throw operation or separate circuit operation having the same polarity. Four-circuit contact blocks may be arranged for double-pole double-throw operation or separate circuit operation having the same polarity.

2-Circuit Contact Ratings — NEMA A600 (ICS 2-125)

Maximum AC Voltage	AC				DC		
	A		Continuous Carrying Current	VA		Maximum Voltage	[A]
	Make	Break		Make	Break		
120	60	6.00	10	7200	720	115...125	0.4
240	30	3.00	10	7200	720	230...250	0.2
480	15	1.50	10	7200	720	550...600	0.1
600	12	1.20	10	7200	720	—	—

IEC 337-1

Maximum Operational Voltage U_e	Utilization Category	Maximum Continuous Current I^{th}	Volts U_e	Rated Operational Current	
				Make 	Break
AC600	AC-11	10	120...600 AC	7200 VA	720 VA
		10	72...120 AC	60 A	720 VA
DC600	DC-11	10	24...72 AC	60 A	10 A
		—	115...600 DC	50 VA	50 VA

4-Circuit Contact Ratings — NEMA B150 (ICS 2-125)

Maximum AC Voltage	AC				DC		
	A		Continuous Carrying Current	VA		Maximum Voltage	[A]
	Make	Break		Make	Break		
120	30	3.00	5	3600	360	115...120	0.33
240	27.5	2.80	5	6600	660	230...240	0.17

IEC 337-1

Maximum Operational Voltage U_e	Utilization Category	Maximum Continuous Current I^{th}	Volts U_e	Rated Operational Current	
				Make 	Break
AC150	AC-11	5	72...120 AC	30 A	360 VA
		5	24...72 AC	30 A	3 A
DC150	DC-11	—	115...240 DC	40 VA	40 VA

Note: NEMA does not rate contacts to switch low voltage and current. Bulletin 836T Styles T and D Pressure Controls are supplied with silver contacts. The devices are designed to deliver high force snap action to the contacts. This provides exceptional contact fidelity at 24V DC I/O card current level entry when the integrity of the enclosure is maintained.

Contact Wiring Configurations

2-Circuit Contact Blocks

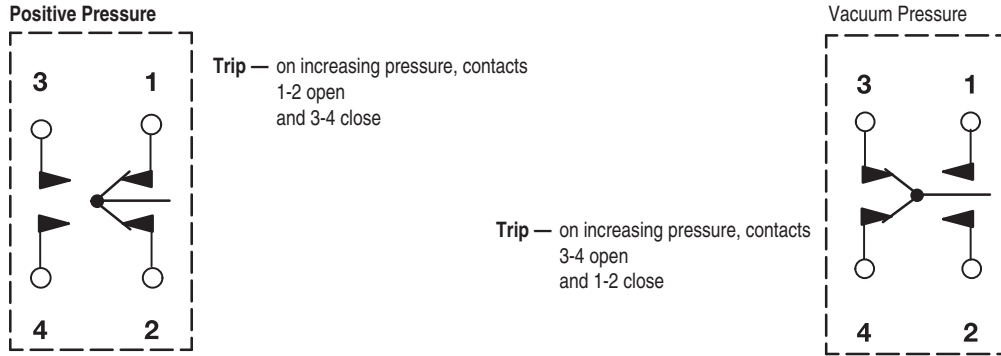

4-Circuit Contact Blocks

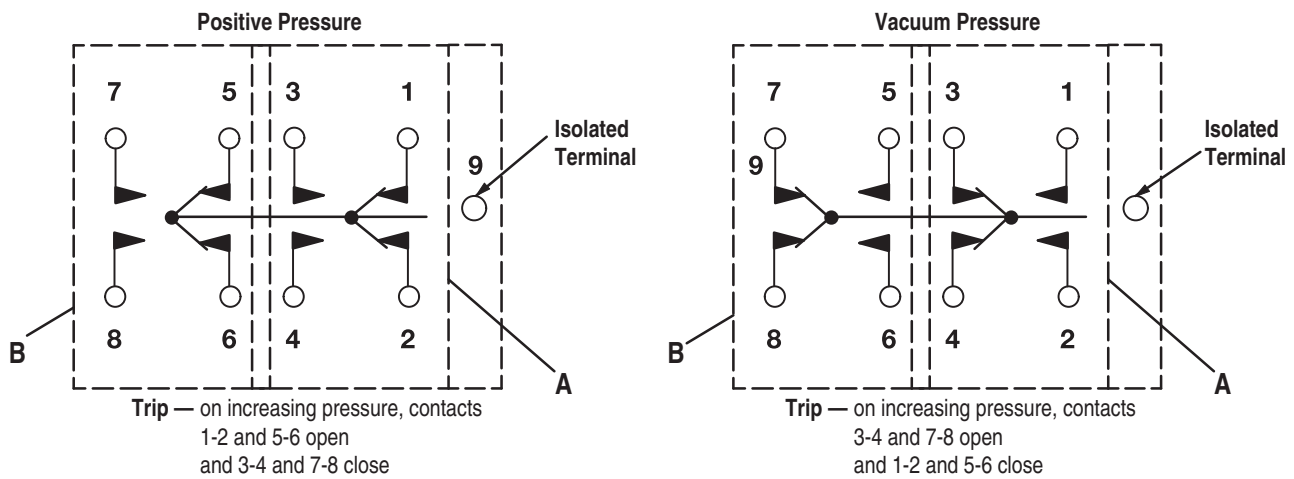

Note: Circuits A and B are electrically isolated from one another.
A or C circuits must be the same polarity.

Nameplate with Removable Paint Mask

The masks are convenient for the many users who repaint controls to match the machine or color code equipment. Saves costly time-consuming hand masking necessary so as not to conceal product functional specifications and approval listings. This feature is standard on most controls at no additional cost. The paint mask feature cannot be supplied on controls with pilot lights. They are also not available on those devices where it is necessary to remove the mask and add suffix modifications to the catalog number or specific customer identification in the space provided.

Figure 8
 Removable paint mask

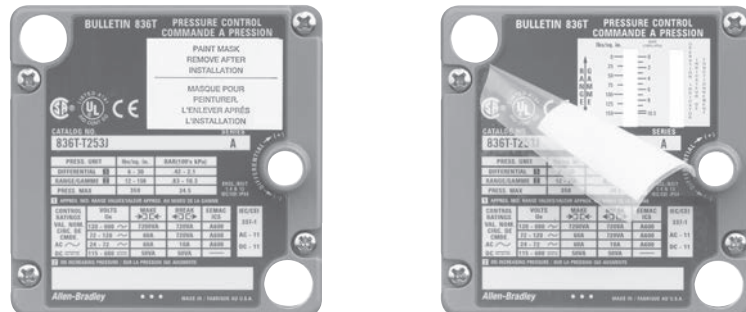

Cover with Transparent Mask and Instruction Label in Place

Cover with Mask Partially Removed

Pressure Control Selection

The selection table below is an overview of the five types of Bulletin 836T Pressure Controls Rockwell Automation offers. Each type of control is suitable for use on many types of applications. Pressure ranges, pressure connections, enclosure types, and the compatibility of the actuator with different types of pressure media are given to assist in the selection of which type of control to use.

836T				
Actuator Type	Copper Alloy Bellows	Type 316 Stainless Steel Bellows	Piston Type Without Seal	Piston Type With Seal
Adjustable operating ranges	30 in. Hg vacuum...650 psi	30 in. Hg vacuum...375 psi	40...5000 psi	80...5000 psi
Adjustable differentials	2...125 psi	2...90 psi	20...650 psi	40...650 psi
Maximum line pressures	up to 1300 psi	up to 600 psi	—	—
Occasional surge pressures	up to 1600 psi	up to 600 psi	up to 15 000 psi	up to 15 000 psi
Pressure Media				
Air	•	•		
Water	•	•	•	•
Hydraulic fluids	•	•	•	•
Corrosive liquids *		•		
Non-corrosive liquids	•	•	•	•
Corrosive gases *		•		
Non-corrosive gases	•	•		
Enclosures				
Type 1, 4 & 13	•	•	•	•
Type 7 & 9 and 4 & 13, IP66	•	•	•	•
Pipe Connections				
Standard pressure connection	1/4 in. N.P.T. female pipe thread	1/4 in. N.P.T. female pipe thread	3/8 in. N.P.T. female pipe thread SAE 7/16-20 UNF-2B thread O-ring boss seal SAE 9/16-18 UNF-2B thread O-ring boss seal	3/8 in. N.P.T. female pipe thread SAE 7/16-20 UNF-2B thread O-ring boss seal SAE 9/16-18 UNF-2B thread O-ring boss seal

* Corrosive liquids and gases must be compatible with Type 316 Stainless Steel Bellows.

Note: Pressure difference controls are supplied with either copper alloy or stainless steel bellows. See Product Selection on page 13-38 and page 13-39 for details.

Ordering Bulletin 836T Pressure Controls

When ordering Bulletin 836T Pressure Controls, consider the following:

- Device style
- Adjustable operating range
- Adjustable differential
- Maximum line pressure
- Occasional surge pressure
- Pressure media
- Enclosure type
- Pressure connection

How to Order

Step 1: Basic Device

Select a catalog number for the basic device.....See pages 13-34...13-39.

Step 2: Modifications

If required, add the appropriate modification suffix code(s) to the catalog number of the basic device.....See page 13-40.

Step 3: Accessories

If required, order accessories.....See page 13-41.

Step 4: Factory Options

Factory-set pressure controls.....See page 13-43 .

Catalog Number Explanation

Note: Catalog number must not include blank spaces.

836T – T 25 1 J X40 X15
a *b* *c* *d* *e* *f*

a

Style of Device	
Code	Description
T	Pressure control
D	Pressure difference control

c

Pressure Specifications	
See "Pressure Specifications" on pages 13-34...13-39	

e

Contact Block Type	
Code	Description
None	2-circuit contact block - standard
X40	4-circuit contact block

b

Operator Type		
Code	Style	Description
25	T	Copper alloy bellows
26	T	Type 316 stainless steel bellows
30	T	Piston without seal
35	T	Piston with seal
40	T	Piston with seal (independent trip and reset adjustment)
45	D	Copper alloy bellows
46	D	Type 316 stainless steel bellows

d

Enclosure Type	
Code	Description
J	1, 4 & 13 Industrial use
E	7 & 9 and 4 & 13 Combined hazardous locations

f

Modification 1	
Add suffix codes in descending order whenever possible. (Optional. See page 13-40.)	

Pressure Controls

Product Selection — Style T



Style T — Type 1, 4 & 13
with Pilot Light Option



Style T — Type 1, 4 & 13
with Pilot Light, Range Locking Cap,
and 5-Pin Mini-Receptacle

Style T Pressure Controls with Copper Alloy Bellows* — S.P.D.T. 2-Circuit Contact Block

Standard Pressure Controls shipped from the factory are set at the maximum operating range and minimum differential.

Pressure Specifications				Enclosure Type	
Adjustable Operating Range [psi]	Adjustable Differential [psi] (Approximate Mid-Range Values)	Maximum psi		Type 1, 4 & 13	Type 7 & 9 and 4 & 13 ‡
		Line Pressure	Occasional Surge Pressure*	Cat. No.	Cat. No.
30 in. Hg vacuum...35	2...7	80	90	836T-T251J	836T-T251E
6...75	3...15	200	220	836T-T252J	836T-T252E
12...150	6...30	350	450	836T-T253J	836T-T253E
20...300	10...55	600	750	836T-T254J	836T-T254E
40...450	20...90	900	1200	836T-T255J	836T-T255E
60...650	30...125	1300	1600	836T-T256J	836T-T256E

Style T Pressure Controls with Copper Alloy Bellows* — D.P.D.T. 4-Circuit Contact Block

Standard Pressure Controls shipped from the factory are set at the maximum operating range and minimum differential.

Pressure Specifications				Enclosure Type	
Adjustable Operating Range [psi]	Adjustable Differential [psi] (Approximate Mid-Range Values)	Maximum psi		Type 1, 4 & 13	Type 7 & 9 and 4 & 13 ‡
		Line Pressure	Occasional Surge Pressure*	Cat. No.	Cat. No.
30 in. Hg vacuum...35	2.2...7	80	90	836T-T251JX40	836T-T251EX40
6...75	4.5...15	200	220	836T-T252JX40	836T-T252EX40
12...150	9...30	350	450	836T-T253JX40	836T-T253EX40
20...300	15...55	600	750	836T-T254JX40	836T-T254EX40
40...450	30...90	900	1200	836T-T255JX40	836T-T255EX40
60...650	45...125	1300	1600	836T-T256JX40	836T-T256EX40

* Copper alloy bellows may be used on water or air, and other liquids or gases not corrosive to this alloy.

‡ Transients (pulses) can occur in a system prior to reaching a steady-state condition. Surge pressures within published values generated during startup or shutdown of a machine or system, not exceeding eight times in a 24-hour period, are negligible.

‡ The combined Type 7 & 9 and 4 & 13 hazardous gas and dust service enclosure is supplied with special gasket and O-ring seal to diminish/exclude moisture, fluids, and dust from entering the enclosure. Enclosure is rated for the following environments:
CLASS I Groups C,D
CLASS II Groups E,F,G
CLASS III



Style T — Type 1, 4 & 13
 with Pilot Light Option



Style T —
 Type 7 & 9 and 4 & 13

Style T Pressure Controls with Type 316 Stainless Steel Bellows* — S.P.D.T. 2-Circuit Contact Block

Standard Pressure Controls shipped from the factory are set at the maximum operating range and minimum differential.

Pressure Specifications				Enclosure Type	
Adjustable Operating Range [psi]	Adjustable Differential [psi] (Approximate Mid-Range Values)	Maximum psi		Type 1, 4 & 13	Type 7 & 9 and 4 & 13 ‡
		Line Pressure	Occasional Surge Pressure*	Cat. No.	Cat. No.
30 in. Hg vacuum...35	2...7	65	65	836T-T260J	836T-T260E
8...100	4...20	200	200	836T-T261J	836T-T261E
24...250	12...50	500	500	836T-T262J	836T-T262E
40...375	20...90	600	600	836T-T263J	836T-T263E

Style T Pressure Controls with Type 316 Stainless Steel Bellows* — D.P.D.T. 4-Circuit Contact Block

Standard Pressure Controls shipped from the factory are set at the maximum operating range and minimum differential.

Pressure Specifications				Enclosure Type	
Adjustable Operating Range [psi]	Adjustable Differential [psi] (Approximate Mid-Range Values)	Maximum psi		Type 1, 4 & 13	Type 7 & 9 and 4 & 13 ‡
		Line Pressure	Occasional Surge Pressure*	Cat. No.	Cat. No.
30 in. Hg vacuum...35	2.2...7	65	65	836T-T260JX40	836T-T260EX40
8...100	6...20	200	200	836T-T261JX40	836T-T261EX40
24...250	18...50	500	500	836T-T262JX40	836T-T262EX40
40...375	30...90	600	600	836T-T263JX40	836T-T263EX40

* Type 316 stainless steel bellows are available for more corrosive liquids or gases.

* Transients (pulses) can occur in a system prior to reaching a steady-state condition. Surge pressures within published values generated during startup or shutdown of a machine or system, not exceeding eight times in a 24-hour period, are negligible.

‡ The combined Type 7 & 9 and 4 & 13 hazardous gas and dust service enclosure is supplied with special gasket and O-ring seal to diminish/exclude moisture, fluids, and dust from entering the enclosure. Enclosure is rated for the following environments:

- CLASS I Groups C,D
- CLASS II Groups E,F,G
- CLASS III

Pressure Controls

Product Selection — Style T



Style T — Type 1, 4 & 13



Style T —
Type 1, 4 & 13 with Pilot Light,
Mini-Receptacle, SAE Thread

Important Application Information

Piston-type controls are designed for use with oil and high water-based hydraulic fluids containing high-lubricity substances which will not attack alloy steel. Piston-type controls are available without seals to reduce piston friction. Reduced friction results in narrower switch differentials required for some applications.

All piston-type controls are equipped with a diaphragm assembly that conveys the motion of the piston to the mechanism, and prevents any fluid from entering the enclosure. Controls without seals are provided with a drain that should be connected to a line returning the piston bypass fluid to a reservoir for reuse. The reservoir **must** be vented to the atmosphere. Manifold-type return lines that are fed by other equipment and/or contain a back-up check valve are not satisfactory. Extreme transient pulses can develop from hydraulic inertia in the line and rupture the diaphragm located on the secondary side of the piston, forcing fluid into the enclosure. For systems of this type, pressure controls with seals are recommended as return lines are not required if a slight amount of leakage, over time, can be tolerated. **Drains should never be plugged.** It is not recommended that a back pressure of more than the head pressure be applied to the diaphragm. This can occur if the reservoir is located above the machine. Variable back pressure may cause setting instability.

Listed differentials may vary due to piston and cylinder tolerance, and characteristics of the fluid and application. *Do not use piston-type controls on air, gases, or other liquids that will corrode stainless steel.*

Style T Pressure Controls Piston without Seal* — S.P.D.T. 2-Circuit Contact Block

(Hydraulic fluid return line to reservoir is recommended)

Standard Pressure Controls shipped from the factory are set at the maximum operating range and minimum differential.

Pressure Specifications				Enclosure Type	
Adjustable Operating Range [psi]	Adjustable Differential [psi] (Approximate Mid-Range Values)	Maximum psi		Type 1, 4 & 13	Type 7 & 9 and 4 & 13 ‡
		Line Pressure	Occasional Surge Pressure*§	Cat. No.	Cat. No.
40...550	20...75	—	5000	836T-T300J	836T-T300E
70...1000	50...175	—	10000	836T-T301J	836T-T301E
200...3000	125...400	—	15000	836T-T302J	836T-T302E
350...5000	175...650	—	15000	836T-T303J	836T-T303E

Style T Pressure Controls Piston without Seal* — D.P.D.T. 4-Circuit Contact Block

(Hydraulic fluid return line to reservoir is recommended)

Standard Pressure Controls shipped from the factory are set at the maximum operating range and minimum differential.

Pressure Specifications				Enclosure Type	
Adjustable Operating Range [psi]	Adjustable Differential [psi] (Approximate Mid-Range Values)	Maximum psi		Type 1, 4 & 13	Type 7 & 9 and 4 & 13 ‡
		Line Pressure	Occasional Surge Pressure*§	Cat. No.	Cat. No.
40...550	30...75	—	5000	836T-T300JX40	836T-T300EX40
70...1000	60...175	—	10000	836T-T301JX40	836T-T301EX40
200...3000	150...400	—	15000	836T-T302JX40	836T-T302EX40
350...5000	260...650	—	15000	836T-T303JX40	836T-T303EX40

* When phosphate ester base hydraulic fluid is present, a special diaphragm assembly is required. See Modifications, [T-9864960].

§ Transients (pulses) can occur in a system prior to reaching a steady-state condition. Surge pressures within published values generated during startup or shutdown of a machine or system, not exceeding eight times in a 24-hour period, are negligible.

‡ The combined Type 7 & 9 and 4 & 13 hazardous gas and dust service enclosure is supplied with special gasket and O-ring seal to diminish/exclude moisture, fluids, and dust from entering the enclosure. Enclosure is rated for the following environments:

CLASS I Groups C,D
CLASS II Groups E,F,G
CLASS III



Style T — Type 1, 4 & 13



Style T — Type 1, 4 & 13 with Pilot Light,
 Mini-Receptacle, SAE Thread

Important Application Information

Piston-type controls are designed for use with oil and high water-based hydraulic fluids containing high-lubricity substances which will not attack alloy steel. Piston-type controls with seals are designed for applications where a fluid return line is not applicable.

All piston-type controls are equipped with a diaphragm assembly that conveys the motion of the piston to the mechanism, and prevents any fluid that may have by-passed the piston seal over time from entering the enclosure. Controls with seals generally do not require a return line as leakage is minimal. Seals are field replaceable (see page 13-42); however, pistons with seals are provided with a drain to specifically safeguard applications that require returning fluid back to the reservoir. The reservoir **must** be vented to the atmosphere. Manifold-type return lines that are fed by other equipment and/or contain a back-up check valve are not satisfactory. Extreme transient pulses can develop from hydraulic inertia in the line and rupture the diaphragm located on the secondary side of the piston, forcing fluid into the enclosure. **Drains should never be plugged.** It is not recommended that a back pressure greater than the head pressure be applied to the diaphragm. This can occur if the reservoir is located above the machine. Variable back pressure may cause setting instability.

Listed differentials may vary due to piston and cylinder tolerance, and characteristics of the fluid and application. *Do not use piston-type controls on air, gases, or other liquids that will corrode stainless steel.*

Style T Pressure Controls Piston with Seal* — S.P.D.T. 2-Circuit Contact Block (Hydraulic fluid return line to reservoir is not required)

Standard Pressure Controls shipped from the factory are set at the maximum operating range and minimum differential.

Pressure Specifications				Enclosure Type	
Adjustable Operating Range [psi]	Adjustable Differential [psi] (Approximate Mid-Range Values)	Maximum psi		Type 1, 4 & 13	Type 7 & 9 and 4 & 13 ‡
		Line Pressure	Occasional Surge Pressure*	Cat. No.	Cat. No.
80...550	40...75	—	5000	836T-T350J	836T-T350E
140...1000	70...175	—	10 000	836T-T351J	836T-T351E
400...3000	200...400	—	15 000	836T-T352J	836T-T352E
700...5000	350...650	—	15 000	836T-T353J	836T-T353E

Style T Pressure Controls Piston with Seal* — D.P.D.T. 4-Circuit Contact Block (Hydraulic fluid return line to reservoir is not required)

Standard Pressure Controls shipped from the factory are set at the maximum operating range and minimum differential.

Pressure Specifications				Enclosure Type	
Adjustable Operating Range [psi]	Adjustable Differential [psi] (Approximate Mid-Range Values)	Maximum psi		Type 1, 4 & 13	Type 7 & 9 and 4 & 13 ‡
		Line Pressure	Occasional Surge Pressure*	Cat. No.	Cat. No.
80...550	60...75	—	5000	836T-T350JX40	836T-T350EX40
140...1000	100...175	—	10 000	836T-T351JX40	836T-T351EX40
400...3000	300...400	—	10 000	836T-T352JX40	836T-T352EX40
700...5000	525...650	—	15 000	836T-T353JX40	836T-T353EX40

Independent Trip and Reset Adjustment for Wide Differential Applications* — Piston with Seal, S.P.D.T. 2-Circuit Contact Block

(Hydraulic fluid return line to reservoir is not required)

Standard Pressure Controls shipped from the factory are set at the maximum operating range and minimum differential.

Pressure Specifications			Enclosure Type	
Adjustable High Trip Setting [psi]	Adjustable Low Reset Setting [psi]	Occasional Surge Pressure [psi]*	Type 1, 4 & 13	Type 7 & 9 and 4 & 13 ‡
			Cat. No.	Cat. No.
500...3000	0...250	15000	836T-T400J	836T-T400E

* When phosphate ester base hydraulic fluid is present, a special diaphragm and seal assembly is required. See Modifications, page 13-40.

* Transients (pulses) can occur in a system prior to reaching a steady-state condition. Surge pressures within published values generated during startup or shutdown of a machine or system, not exceeding eight times in a 24-hour period, are negligible.

‡ The combined Type 7 & 9 and 4 & 13 hazardous gas and dust service enclosure is supplied with special gasket and O-ring seal to diminish/exclude moisture, fluids, and dust from entering the enclosure. Enclosure is rated for the following environments:
 CLASS I Groups C,D
 CLASS II Groups E,F,G
 CLASS III

Pressure Controls

Product Selection — Style D



Style D — Type 1, 4 & 13
with Pilot Light Option



Style D — Type 1, 4 & 13

Style D Pressure Difference Controls with Copper Alloy Bellows* — S.P.D.T. 2-Circuit Contact Block‡

Standard Pressure Difference Controls shipped from the factory are set at the maximum adjustable difference range and minimum differential.

Pressure Specifications					Enclosure Type 1, 4 & 13
Adjustable System Difference Range [psi]	Adjustable Differential [psi] (Approximate Mid-Range Values)	Line Pressure psi		Max. Occasional Surge Pressure [psi]*	Cat. No.
		Minimum	Maximum		
1...9	1...7	30 in. Hg Vac.	80	90	836T-D450J
2.5...20	2.5...15	30 in. Hg Vac.	175	200	836T-D451J
5...40	5...30	30 in. Hg Vac.	350	375	836T-D452J
10...70	10...50	0	600	650	836T-D453J

Style D Pressure Difference Controls with Copper Alloy Bellows* — D.P.D.T. 4-Circuit Contact Block‡

Standard Pressure Difference Controls shipped from the factory are set at the maximum adjustable difference range and minimum differential.

Pressure Specifications					Enclosure Type 1, 4 & 13
Adjustable System Difference Range [psi]	Adjustable Differential [psi] (Approximate Mid-Range Values)	Line Pressure psi		Max. Occasional Surge Pressure [psi]*	Cat. No.
		Minimum	Maximum		
1...9	1.5...7	30 in. Hg Vac.	80	90	836T-D450JX40
2.5...20	3.75...15	30 in. Hg Vac.	175	200	836T-D451JX40
5...40	7.5...30	30 in. Hg Vac.	350	375	836T-D452JX40
10...70	15...50	0	600	650	836T-D453JX40

* Copper alloy bellows may be used on water or air, and other liquids or gases not corrosive to this alloy.

* Transients (pulses) can occur in a system prior to reaching a steady-state condition. Surge pressures within published values generated during startup or shutdown of a machine or system, not exceeding eight times in a 24-hour period, are negligible.

‡ Finger-safe shield supplied standard.



Style D — Type 1, 4 & 13
 with Pilot Light Option



Style D — Type 1, 4 & 13

Style D Pressure Difference Controls with Type 316 Stainless Steel Bellows* — S.P.D.T. 2-Circuit Contact Block‡

Standard Pressure Difference Controls shipped from the factory are set at the maximum adjustable difference range and minimum differential.

Pressure Specifications					Enclosure Type 1, 4 & 13
Adjustable System Difference Range [psi]	Adjustable Differential [psi] (Approximate Mid-Range Values)	Line Pressure [psi]		Max. Occasional Surge Pressure [psi]*	Cat. No.
		Minimum	Maximum		
1...9	1...7	30 in. Hg Vac.	65	65	836T-D460J
5...25	4...15	0	175	200	836T-D462J
12...70	12...50	0	500	500	836T-D463J

Style D Pressure Difference Controls with Type 316 Stainless Steel Bellows* — D.P.D.T. 4-Circuit Contact Block‡

Standard Pressure Difference Controls shipped from the factory are set at the maximum adjustable difference range and minimum differential.

Pressure Specifications					Enclosure Type 1, 4 & 13
Adjustable System Difference Range [psi]	Adjustable Differential [psi] (Approximate Mid-Range Values)	Line Pressure [psi]		Max. Occasional Surge Pressure [psi]*	Cat. No.
		Minimum	Maximum		
1...9	1.5...7	30 in. Hg Vac.	65	65	836T-D460JX40
5...25	6...15	0	175	200	836T-D462JX40
12...70	18...50	0	500	500	836T-D463JX40

* Type 316 stainless steel bellows are available for more corrosive liquids or gases.

* Transients (pulses) can occur in a system prior to reaching a steady-state condition. Surge pressures within published values generated during startup or shutdown of a machine or system, not exceeding eight times in a 24-hour period, are negligible.

‡ Finger-safe shield supplied as standard.

Bulletin 836T
Pressure Controls
Modifications

Ordering Modifications

Modifications are ordered by adding the appropriate modification suffix code to the catalog number of the basic device. Add suffix codes to the catalog number in descending order.

Item	Description	Suffix Code
Oxygen/nitrous oxide service	Bellows and fittings specially prepared for oxygen and nitrous oxide service. Devices tested with pure oxygen, bellows plugged for protection from contamination and a tag warning against contamination is applied.	X2
External adjustment sealed	The 836T external adjustment is sealed, requiring cover removal to adjust differential (includes contact block shield)	X3
Tamper resistant setting	Range and differential adjustments are factory sealed. Price includes factory setting charge.*	X4
SAE 7/16-20 UNF thread O-ring boss seal (piston type pressure control)	Female SAE straight thread O-ring seal designed to prevent leaks and minimize loss of hydraulic fluids.	X6
SAE 9/16-18 UNF thread O-ring boss seal (piston type pressure control)		X7
Neon pilot light 120V AC	A high-intensity neon pilot light for 120V AC, 60 Hz applications is available and can be wired for ON or OFF operation. The current rating is 1.0 mA.*	X9
Red LED pilot light 24V DC	A high-intensity LED 24V DC pilot light is available to meet the requirements of the automotive, machine tool builders, and other industries. The current rating is 22 mA and can be wired for ON or OFF operation.*	X15
Green LED pilot light 24V DC		X18
Special diaphragm assembly (piston type pressure control)	Diaphragm is made of Viton® and Nomex® fabric. Required when phosphate ester base and other adverse hydraulic fluids are present. Use on Catalog Numbers 836T-T300J through 836T-T303J series controls.	X25
Special diaphragm and O-ring assembly (piston type pressure control)	Diaphragm is made of Viton® and Nomex® fabric, O-ring is made of Viton®. Required when phosphate esterbase and other adverse hydraulic fluids are present. Use on Catalog Numbers 836T-T350J, -T351J, -T352J, -T353J and -T400J series controls.	X26
Viton® enclosure gaskets	Special enclosure gaskets made of Viton® are available for applications where the standard gasket materials are not fluid compatible. Viton® is generally specified by the user for use with existing and newly developed coolants and hydraulic fluids to maintain enclosure integrity. These include cover, backplate, cover, and bellows or piston gaskets. Note: Viton® enclosure gaskets are often used with special diaphragm assemblies (X25 or X26). See description above.	X29
5-Pin mini-type receptacle without pilot light*	Select the desired pin wiring configuration from the Wiring Diagrams. Rated at 8 A, 600V.	See Wiring Diagrams.
5-Pin mini-type receptacle with prewired pilot light*	Select the desired pin wiring, pilot light wiring, and voltage from the Wiring Diagrams. Includes receptacle and pilot light. Rated at 8 A, 600V.	See Wiring Diagrams.
5-Pin micro-connect receptacle without pilot light*	Select the desired pin wiring configuration from the Wiring Diagrams. Add number "1" to the suffix number immediately following the letter "X." Example: "X19" becomes "X119." Rated at 3 A, 300V. Pin/Wiring Code: 1 – Red with white tracer, 2 – Red, 3 – Green (Gnd), 4 – Red with yellow tracer, 5 – Red with Black Tracer	See Wiring Diagrams.
5-Pin micro-connect receptacle with prewired pilot light*	Select the desired pin wiring configuration and pilot light (X9 or X15, see above for specifications) from the Wiring Diagrams. Add number "1" to the Suffix Number immediately following the letter "X." Example: "X12X9" becomes "X121X9." Rated at 3 A, 300V. Pin/Wiring Code: 1 – Red with white tracer, 2 – Red, 3 – Green (Gnd), 4 – Red with yellow tracer, 5 – Red with black tracer	See Wiring Diagrams.
Additional optional receptacles and wiring*	For assistance, please consult your local Rockwell Automation sales office or Allen-Bradley distributor.	

* See page 13-43.

* Not available on the Type 7 & 9 and 4 & 13 combined enclosed devices.



Ordering Accessories

Accessories are ordered as separate catalog numbers. Select the required accessories from the accessories table below.

Item	Description	Type	Cat. No.
External fixed pulsation snubbers	Controls are supplied as standard with an internal pulsation snubber. However, a control properly selected and used within the adjustable range values, yet having a short bellows life, is a good indication of the presence of extreme surge pressures. External fixed pulsation snubbers are available to provide additional dampening when extreme pulsations or surges are present. Recommended if more than eight line surges occur in a 24-hour time period.	Snubber for bellows control 1/4-18 N.P.T. thread	836-N7
		Snubber for piston control 3/8-18 N.P.T. thread	836T-N8
Selectable element pulsation snubbers	Controls are supplied as standard with an internal pulsation snubber. However, a control properly selected and used within the adjustable range values, yet having a short bellows life, is a good indication of the presence of extreme surge pressures. Selectable element pulsation snubbers are supplied with five different elements to provide a selectable balance between maximizing pressure control life and minimizing control response time. Pulsation snubbers are supplied with the mid-range element already mounted and four other color-coded porosity elements included in the package. See "Selectable Pulsation Snubber Porosity Elements" table on this page for porosity specifications.	Snubber for bellows control 1/4-18 N.P.T. thread	836-N40
		Snubber for piston control 3/8-18 N.P.T. thread	836T-N41
	Female SAE straight thread O-ring seal designed to prevent leaks and minimize loss of hydraulic fluids. Use on applications with a pressure range of 550...5000 psi.	SAE 7/16-20 UNF-2B thread O-ring boss seal for piston controls	836T-N49
		SAE 9/16-18 UNF-2B thread O-ring boss seal for piston controls	836T-N50
Selectable pulsation snubber porosity elements	Package consists of five porosity elements and complete instructions. Elements are color-coded for easy identification. Elements are available in five different porosities for a wide range of applications. See selectable pulsation snubber porosity elements table.		See Table on this page
Locking cap	Deters unauthorized tampering of range setting. Once installed, the locking cap can be removed with a screwdriver to re-adjust the control.	—	836T-N13
Isolation trap with two 1/4 in. male pipe fittings	An isolation trap is available for high-temperature media applications from 150...600 °F or corrosive applications compatible with Type 316 stainless steel tubing and fittings. The isolation coil is inserted between the bellows of the pressure control and the elevated temperature line of the system. The isolation trap will fill with condensed water or can be filled with water or suitable fluid when installed. A silicone buffer fluid is available in a convenient dispenser. Copper alloy lower and higher pressure range bellows can be applied to many applications using the isolation trap. The silicone buffer fluid is used to isolate many corrosive substances from coming in contact with the bellows. The isolation trap is rated at 3000 psi working pressure. Not available for piston-type controls. See photo on [S-9864788]		836-N25
Isolation trap with one 1/4 in. male and one 1/4 in. female pipe fittings			836-N26
2 oz. of buffer fluid to fill bellows and tubing			836-N27
Metric electrical entry conduit adapters	BS 20 mm thread adapter		836T-N36
	Pg 13.5 thread adapter		836T-N37

Selectable Pulsation Snubber Porosity Elements

Recommended Type of Service	Color Code	Porosity	Cat. No.
Viscous fluids (over 500 SSU)*	None		836-N43
Medium type oils (225...500 SSU)*	Black		836-N44
Water and light oils (30... 225 SSU)*	Brown		836-N45
Low viscosity fluids (under 30 SSU)*	Green		836-N46
Air and other gases	Red	Finer	836-N47
One of each of the above	—	Assorted	836-N48

* Saybolt Seconds Universal (SSU) — units of viscosity measurement.

Note: Color code is located on end of element.

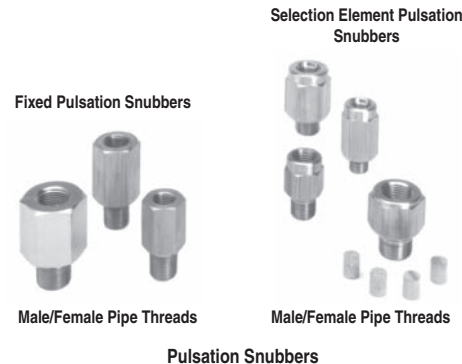

Pressure Controls

Conversion Kits & Renewal Parts

Conversion Kits

Ordering Conversion Kits

Conversion Kits are ordered by adding the appropriate suffix code to the catalog number of the basic device. Select the required conversion kits from the table below.

Conversion Kits

Item	Description	Suffix Code
Neon pilot light conversion kit	Converts standard control to control with 120V AC neon pilot light. Not available on Type 7 & 9 devices. Kit includes pilot light and cover assembly.	N9
Red LED pilot light conversion kit	Converts standard control to control with 24V DC LED pilot light; has a 22 mA current rating. Not available on Type 7 & 9 devices. Kit includes pilot light and cover assembly.	N15
Green LED pilot light conversion kit	Converts standard control to control with 24V DC LED pilot light; has a 22 mA current rating. Not available on Type 7 & 9 devices. Kit includes pilot light and cover assembly.	N18

Example:

To convert a **Cat. No. 836T-T301J** to a **Cat. No. 836T-T301JX15**, order **Cat. No. 836T-T301JN15**.

Renewal Parts

Ordering Renewal Parts

Renewal Parts are ordered as separate catalog numbers. Select the required renewal parts from the table below.

Renewal Parts

Item	Description	Cat. No.
2-Circuit contact block renewal kit	Allows renewal of worn contacts for Bulletin 836T controls.	836T-N1
4-Circuit contact block renewal kit	Allows renewal of worn contacts for Bulletin 836T controls.	836T-N2
Renewal seals for piston-type controls	For use on Cat. No. 836T-T350J.	836T-N20
	For use on Cat. No. 836T-T351J.	836T-N21
	For use on Cat. No. 836T-T352J and 836T-T400J.	836T-N22
	For use on Cat. No. 836T-T353J.	836T-N23

Factory-Set Pressure Controls

Ordering Factory-Set Pressure Controls

- When a specific factory setting is requested, the specific terminal connections must be specified — e.g., N.O. or N.C. It must also be specified whether the contact operation is occurring on either increasing or decreasing pressure. For example:

Normally Closed (N.C.) contacts to open at* psi increasing pressure and close at* psi decreasing pressure.

—OR—

Normally Open (N.O.) contacts to close at* psi increasing pressure and open at* psi decreasing pressure.

- If minimum differential is not critical and the inherent minimum differential satisfies the application, specify the factory setting as follows:

Normally Closed (N.C.) contacts to open at* psi increasing pressure minimum differential.

—OR—

Normally Open (N.O.) contacts to close at* psi increasing pressure minimum differential.

Quality analog test gauges§ are used when applying requested factory settings to these rugged industrial grade pressure controls. (Gauges are calibrated and accuracy is traceable to the The National Institute of Standards and Technology.)

The actual requested setting is applied to the control by reading the set point directly from the test gauge being used. However, traceable gauge tolerance variance between source and user, and possible severe shock during shipping and installation, may contribute to the factory settings deviating slightly from the specified values. Slight recalibration can easily be accomplished upon final installation to meet specific requirements for the more demanding applications.

When installed, the controls will perform with a repeat accuracy as established in the paragraph entitled "Repeat Accuracy" (see page 13-53). Special service is available to factory-set controls on digital laboratory instruments, up to 600 psi, when required for more critical applications. An additional charge may be added for this service contingent upon setting tolerance and quantity. Please contact your local Rockwell Automation sales office or Allen-Bradley distributor.

* Specify psi (pounds per square inch) or, in. Hg vac (inches of mercury vacuum).

§ Per ANSI B40.1 Grade 2A (0.5% accuracy full scale), Grade 3A (0.25% accuracy full scale).

If not specified, setting tolerances will be as shown in the table below.

Pressure Range	Tolerance
30 in. Hg Vac...0	+/- 1 in. Hg vac.
> 0...100 psi	+/- 1 psi
> 100...300 psi	+/- 2 psi
> 300...500 psi	+/- 5 psi
> 500...1000 psi	+/- 10 psi
> 1000...5000 psi	+/- 50 psi

Standards Compliance

- UL508
- UL698, 1604 (Haz. Loc.)
- CSA 22,2 No. 14
- NEMA ICS-2

Certifications



File and Guide Numbers

	UL		CSA	
	File Number	Guide Number	File Number	Class
Bulletin 836T	E14842	NKPZ	LR1234	3211-03
	E53048 (Haz. Loc.)	NOWT	LR11924 (Haz. Loc.)	3218-05
Hazardous Location enclosure devices are not CE compliant. All other enclosed devices are CE compliant.				

Pressure Controls

Wiring Diagrams – J1 Wiring

Bulletin 836T 5-Pin Mini-Type Receptacle Option Wiring Reference

(J1 Wiring)

(See applicable codes and laws)

Without Pilot Light

Suffix X19

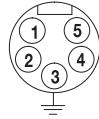
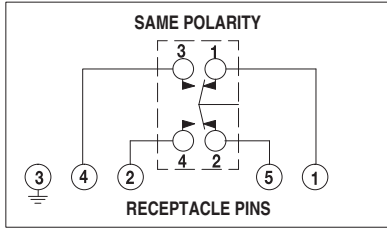

PIN/WIRE CODE
 1= White
 2= Red
 3= Green
 4= Orange
 5= Black

PRESSURE: CIRCUIT 1-2 (PINS 1&5)
 OPENS ON RISING PRESSURE
VACUUM: CIRCUIT 3-4 (PINS 4 & 2)
 OPENS ON INCREASING VACUUM
 (TOWARD 30 in. HG)

With Pilot Light*

Suffix X21X9

WITH NEON GLOW PILOT LIGHT 120V AC ONLY
 PILOT LIGHT WIRED ACROSS CIRCUIT
 1-2 (PINS 1 & 5)

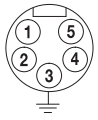
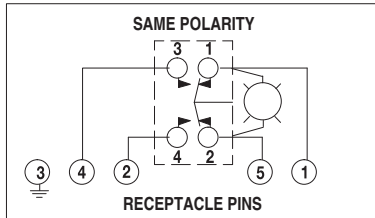

PIN/WIRE CODE
 1= White
 2= Red
 3= Green
 4= Orange
 5= Black

PRESSURE: CIRCUIT 1-2 (PINS 1&5)
 OPENS ON RISING PRESSURE
VACUUM: CIRCUIT 3-4 (PINS 4 & 2)
 OPENS ON INCREASING VACUUM
 (TOWARD 30 in. HG)

Suffix X21X15

WITH LED PILOT LIGHT 24V DC ONLY
 PILOT LIGHT WIRED ACROSS CIRCUIT
 1-2 (PINS 1 & 5)

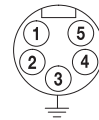
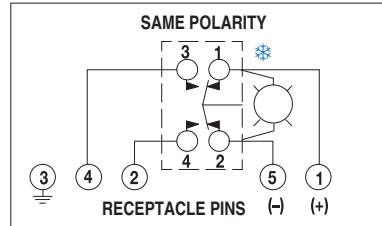

PIN/WIRE CODE
 1= White
 2= Red
 3= Green
 4= Orange
 5= Black

PRESSURE: CIRCUIT 1-2 (PINS 1 & 5)
 OPENS ON RISING PRESSURE
VACUUM: CIRCUIT 3-4 (PINS 4 & 2)
 OPENS ON INCREASING VACUUM
 (TOWARD 30 in. HG)

Suffix X22X9 ‡

WITH NEON GLOW PILOT LIGHT 120V AC ONLY
 PILOT LIGHT WIRED ACROSS CIRCUIT
 3-4 (PINS 4 & 2)

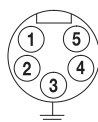
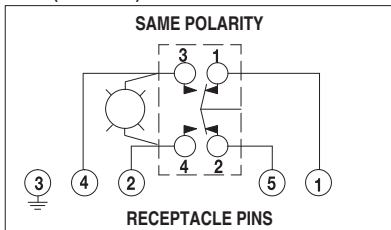

PIN/WIRE CODE
 1= White
 2= Red
 3= Green
 4= Orange
 5= Black

PRESSURE: CIRCUIT 1-2 (PINS 1 & 5)
 OPENS ON RISING PRESSURE
VACUUM: CIRCUIT 3-4 (PINS 4 & 2)
 OPENS ON INCREASING VACUUM
 (TOWARD 30 in. HG)

Suffix X22X15 ‡

WITH LED PILOT LIGHT 24V DC ONLY
 PILOT LIGHT WIRED ACROSS CIRCUIT
 3-4 (PINS 4 & 2)

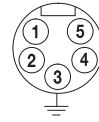
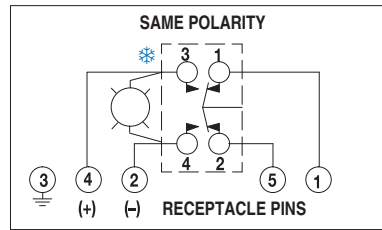

PIN/WIRE CODE
 1= White
 2= Red
 3= Green
 4= Orange
 5= Black

PRESSURE: CIRCUIT 1-2 (PINS 1 & 5)
 OPENS ON RISING PRESSURE
VACUUM: CIRCUIT 3-4 (PINS 4 & 2)
 OPENS ON INCREASING VACUUM
 (TOWARD 30 in. HG)

* The pilot lights shown in these diagrams are wired across the terminals and in series with the load. Pilot light is OFF when the load is energized, ON when the load is de-energized. For simultaneous energization of the load and pilot light, or other optional wiring configurations, consult your local Rockwell Automation sales office or Allen-Bradley distributor.

‡ Note pilot light polarity.

‡ X22 not available with 4-circuit pressure controls.

Bulletin 836T 5-Pin Mini-Type Receptacle Option Wiring Reference

(J9 Wiring)

(See applicable codes and laws)

Without Pilot Light

Suffix X20

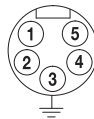
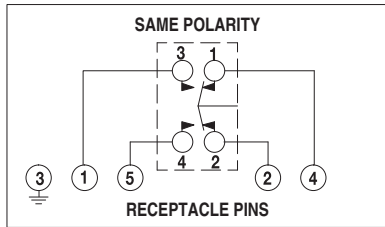

PIN/WIRE CODE
 1= White
 2= Red
 3= Green
 4= Orange
 5= Black

PRESSURE: CIRCUIT 1-2 (PINS 4 & 2)
 OPENS ON RISING PRESSURE
VACUUM: CIRCUIT 3-4 (PINS 1 & 5)
 OPENS ON INCREASING VACUUM
 (TOWARD 30 in. HG)

With Pilot Light*

Suffix X23X9

WITH NEON GLOW PILOT LIGHT 120V AC ONLY
 PILOT LIGHT WIRED ACROSS CIRCUIT
 1-2 (PINS 4 & 2)

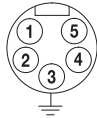
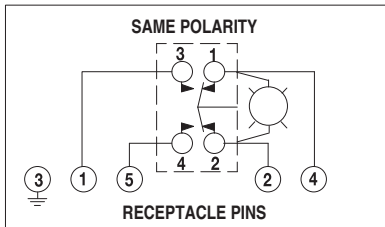

PIN/WIRE CODE
 1= White
 2= Red
 3= Green
 4= Orange
 5= Black

PRESSURE: CIRCUIT 1-2 (PINS 4 & 2)
 OPENS ON RISING PRESSURE
VACUUM: CIRCUIT 3-4 (PINS 1 & 5)
 OPENS ON INCREASING VACUUM
 (TOWARD 30 in. HG)

Suffix X23X15

WITH LED PILOT LIGHT 24V DC ONLY
 PILOT LIGHT WIRED ACROSS CIRCUIT
 1-2 (PINS 4 & 2)

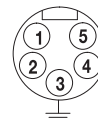
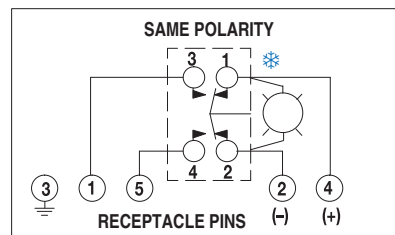

PIN/WIRE CODE
 1= White
 2= Red
 3= Green
 4= Orange
 5= Black

PRESSURE: CIRCUIT 1-2 (PINS 4 & 2)
 OPENS ON RISING PRESSURE
VACUUM: CIRCUIT 3-4 (PINS 1 & 5)
 OPENS ON INCREASING VACUUM
 (TOWARD 30 in. HG)

Suffix X24X9

WITH NEON GLOW LIGHT 120V AC ONLY
 PILOT LIGHT WIRED ACROSS CIRCUIT
 3-4 (PINS 1 & 5)

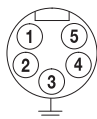
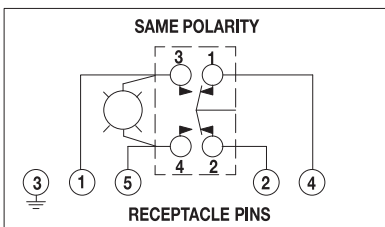

PIN/WIRE CODE
 1= White
 2= Red
 3= Green
 4= Orange
 5= Black

PRESSURE: CIRCUIT 1-2 (PINS 4 & 2)
 OPENS ON RISING PRESSURE
VACUUM: CIRCUIT 3-4 (PINS 1 & 5)
 OPENS ON INCREASING VACUUM
 (TOWARD 30 in. HG)

Suffix X24X15

WITH LED PILOT LIGHT 24V DC ONLY
 PILOT LIGHT WIRED ACROSS CIRCUIT
 3-4 (PINS 1 & 5)

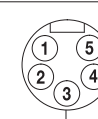
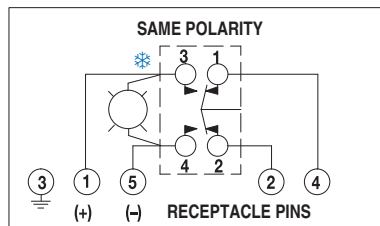

PIN/WIRE CODE
 1= White
 2= Red
 3= Green
 4= Orange
 5= Black

PRESSURE: CIRCUIT 1-2 (PINS 4 & 2)
 OPENS ON RISING PRESSURE
VACUUM: CIRCUIT 3-4 (PINS 1 & 5)
 OPENS ON INCREASING VACUUM
 (TOWARD 30 in. HG)

* The pilot lights shown in these diagrams are wired across the terminals and in series with the load. Pilot light is OFF when the load is energized, ON when the load is de-energized. For simultaneous energization of the load and pilot light, or other optional wiring configurations, consult your local Rockwell Automation sales office or Allen-Bradley distributor.

* Note pilot light polarity.

Bulletin 836T 5-Pin Mini-Type Receptacle Option Wiring Reference

(See applicable codes and laws)

With Pilot Light

Suffix X81X9

WITH NEON GLOW LIGHT 120V AC ONLY
 RATED 600V 8 AMPS

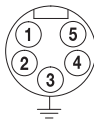
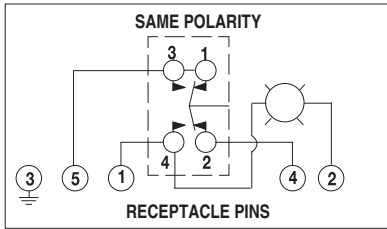

PIN/WIRE CODE
 1= White
 2= Red
 3= Green
 4= Orange
 5= Black

PRESSURE: CIRCUIT 1-2 (PINS 5 & 4)
 OPENS ON RISING PRESSURE
VACUUM: CIRCUIT 3-4 (PINS 5 & 1)
 OPENS ON INCREASING VACUUM
 (TOWARD 30 in. HG)

Suffix X81X15

WITH LED PILOT LIGHT 24V DC ONLY
 RATED 600V 8 AMPS

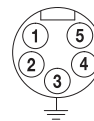
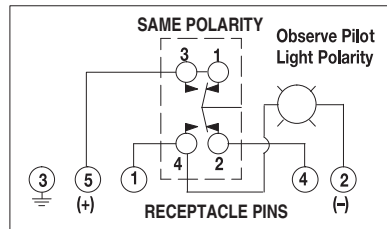

PIN/WIRE CODE
 1= White
 2= Red
 3= Green
 4= Orange
 5= Black

PRESSURE: CIRCUIT 1-2 (PINS 5 & 4)
 OPENS ON RISING PRESSURE
VACUUM: CIRCUIT 3-4 (PINS 5 & 1)
 OPENS ON INCREASING VACUUM
 (TOWARD 30 in. HG)

Note: Bulletin 836T Suffix "X81" Wiring — load and pilot light simultaneously energize when contacts displace (contact terminals 3 and 4 close) at a predetermined pressure setting.

Approximate Dimensions and Shipping Weights

Dimensions in inches (millimeters). Dimensions are not intended to be used for manufacturing purposes.

**Type 4 & 13
 (Bellows)**

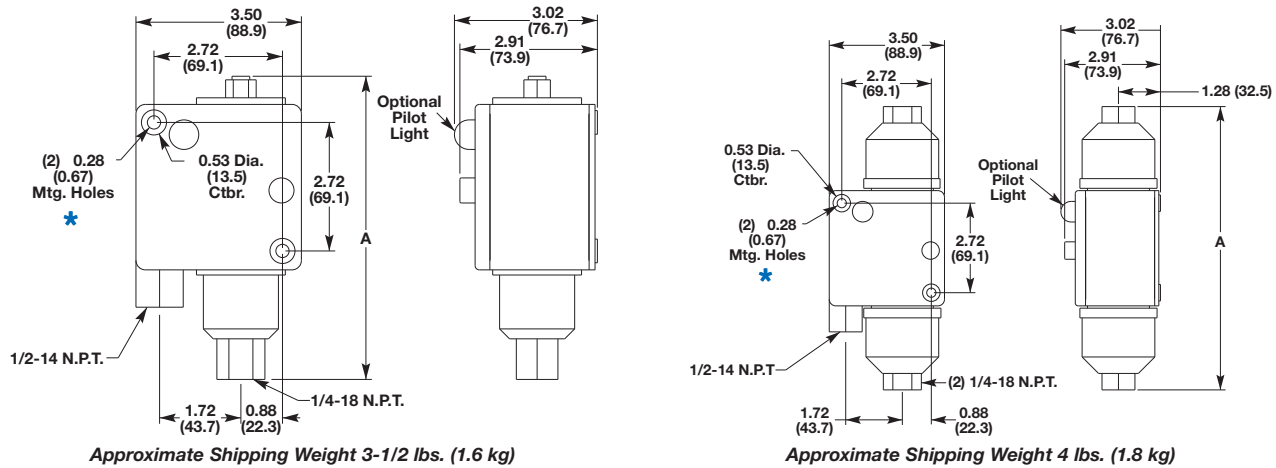

Approximate Shipping Weight 3-1/2 lbs. (1.6 kg)

Approximate Shipping Weight 4 lbs. (1.8 kg)

Cat. No.	A Dimensions	Cat. No.	A Dimensions	Cat. No.	A Dimensions	Cat. No.	A Dimensions
836T-T251J	6.65 (169)	836T-T254J	6.95 (176)	836T-D450J	8.60 (218)	836T-D460J	8.60 (218)
836T-T260J		836T-T255J		836T-D451J			
—	—	836T-T256J	7.09 (180)	836T-D452J	8.14 (207)	836T-T252J	8.5 (216)
836T-T252J	6.41 (163)	836T-T262J	7.33 (186)	836T-D453J	9.5 (241)	836T-D463J	10.06 (256)
836T-T253J		836T-T263J	7.25 (184)				
836T-T261J							

**Type 4 & 13
 (Piston)**

(Does not include Dual Bellows Devices)

**Type 4 & 13 and 7 & 9
 Bellows and Piston Type**

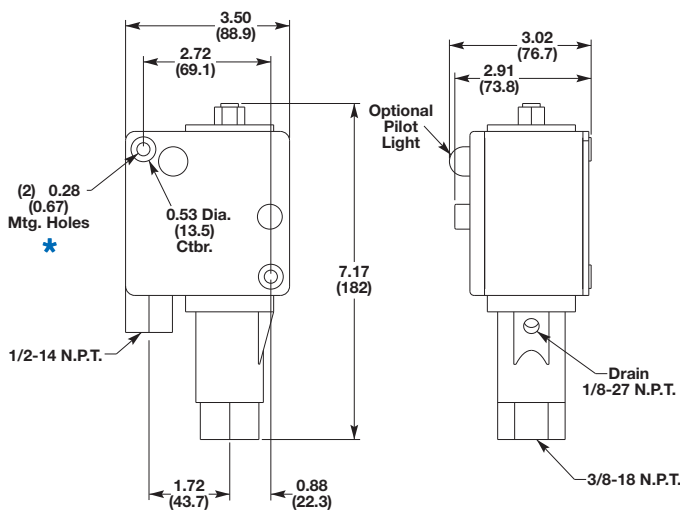

Approximate Shipping Weight 4.5 lbs. (2.0 kg)

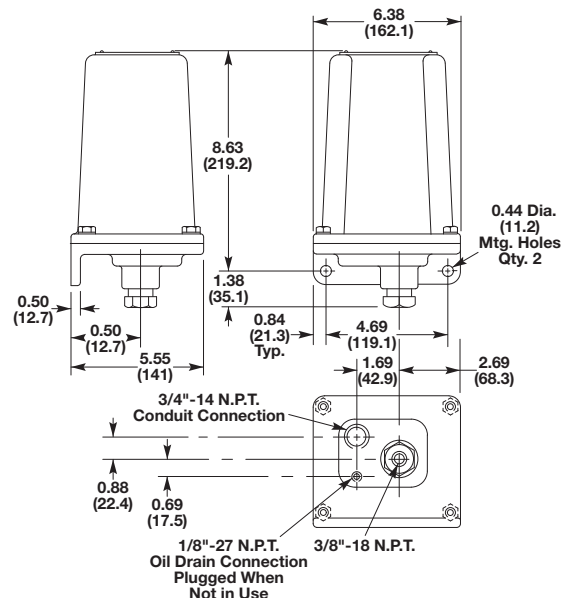

Approximate Shipping Weight 10 lbs. (4.5 kg)

* (2) mounting screws are required: 3/16 x 20 x 2 in. Counterbore depth is 1-1/8 in. Overall depth of mtg hole (front to back) is 2-1/4 in.

Cat. No.	
836T-T300J	836T-T350J
	836T-T351J
836T-T301J	836T-T352J
836T-T302J	836T-T353J
836T-T303J	836T-T400J