

802T

Introduction



Plug-in Style
802T-AP with
Lever

NonPlug-in Style
802T-A with
Lever

Description

Bulletin 802T limit switches are ideal for applications in which heavy duty pilot ratings, small size, a high degree of versatility and a rugged NEMA Type 4 and 13 oiltight construction are desirable. An important factor in the automation of industry, these limit switches are being applied extensively on conveyor systems, transfer machines, automatic turret lathes, milling and boring machines, radial drills, and many other types of modern, high speed production equipment.

High Degree of Versatility

Bulletin 802T limit switches can be mounted in any position, with operating heads that can be rotated and fastened in any one of four positions 90° apart. Most operating levers are interchangeable and can be rotated and clamped in any position through 360°. Accessories can be added to switches already in the field.

NEMA Type 4, 13 and 6P ① Oiltight Construction

802T limit switches feature NEMA Type 4 and 13 construction with synthetic rubber seals to protect the operating parts against entry of oil, dust, abrasives, water and coolant, within the limits of NEMA-specified tests.

① Plug-in lever type except low-torque models.

Rugged, Dependable Contact Block

The contacts used in Bulletin 802T switches are snap-action type with high snap-through force resulting in minimum contact rebound. Double break, fine silver contacts are electrically independent, but cannot be used on opposite polarities.

Easy Mounting and Wiring

Each switch base has four mounting holes: two “through” holes for front mounting and two tapped holes in the back for rear mounting. The pressure plate type terminals on the contact block face to the front of the switch and have ample wiring space around them. The switch conduit opening is a 1/2-inch threaded pipe tap in the bottom of the housing.

Direct Opening Action Position Interlock Switches

Bulletin 802T Direct Opening Action limit switches have been designed for use in control reliable applications and safety applications per ISO 14119.

Direct Opening Action assures that the normally closed contacts open when the limit switch is actuated. This opening will occur even in the event of a contact weld condition, up to 10 Newtons.

Lever Type Switches

These switches are operated by means of a lever which is clamped to a knurled shaft extending from the operating head.

Lever type switches can be equipped with a variety of operating levers: roller lever, adjustable roller lever, micrometer adjustment roller lever, rod lever, one-way rod or roller lever and fork lever. These can be used interchangeably on all lever type switches except the **low operating force switch**.

Push Type Switches

These switches are actuated by means of a rod or plunger located on the top or side of the operating head. Pushing the plunger into the head causes the contacts to operate. Two types of plungers are available: rod type and steel roller. Side push rod switches can be supplied in spring return or maintained contact constructions. An adjustable length top push rod is also

available. The contacts are snap-acting with high snap-through force resulting in minimum contact rebound.

Wobble Stick and Cat Whisker Type Switches

Both switches are actuated by a rod or wire extending from the top of the operating head. Moving the rod through a specified angle in any direction causes the contacts to operate. All wobble stick and cat whisker switches are supplied with spring return construction only. The contacts are snap-action type with high snap-through force resulting in minimum contact rebound.

Dual Switches

The dual switch is actually two limit switches which function independently but have a common enclosure. These switches are used for installations where two switches would be mounted side by side. There is a saving on installation time and fittings (see page 5-71).

Plug-in Switches

Plug-in style limit switches can reduce costly downtime by eliminating the need for rewiring switches. The head and switch body can be replaced without disturbing the wiring chamber in the base. These units, featuring a castle lock head design, snap-action contacts and reliable plug-in connection are available in 2-circuit or 4-circuit construction. Plug-in style limit switches are listed on page 5-41.

Four-Circuit NonPlug-in Switches

These switches contain two single pole single throw contact blocks (a total of two N.O. and two N.C. contacts) mounted in a common enclosure. The blocks are mounted one above the other in the vertical limit switch construction, or side by side in the horizontal construction. Switch plungers are mechanically coupled in both constructions. When actuated, contacts in both blocks are operated. These switches in both types of construction are listed on page 5-54.

General Information

Plug-in Style page 5-41
NonPlug-in Style page 5-54

Operating Levers

Lever Selection page 5-130



Description

Bulletin 802T limit switches are ideal for applications in which heavy duty pilot ratings, small size, a high degree of versatility and a rugged NEMA Type 4, 13 and 6P¹ construction are desirable. An important factor in the automation of industry, these limit switches are being applied extensively on conveyor systems, transfer machines, automatic turret lathes, milling and boring machines, radial drills, and many other types of modern, high speed production equipment.

A wide variety of operating heads and operating levers are available. Operating heads can be mounted in four positions, 90° apart.

Features

- Front mount for simplified mounting
- Plug-in style for ease of wiring
- Side rotary, wobble stick, cat whisker, adjustable top and top or side push styles with and without rollers
- Quick mode change to clockwise and counterclockwise operation only
- Castle lock head design for high durability

¹ Plug-in lever type except low-torque models.

² Temperature range below 0 °C (+32 °F) is based on the absence of freezing moisture or water. See page 5-53 for low temperature options.

³ Low operating torque-spring return ratings only.

Specifications

Enclosure Rating	NEMA 4, 13, 6P ¹ and IP67
Pollution Degree	3
Certifications	UL Listed, CSA Certified CE Marked for applicable directives
Ambient Temperature [C (F)] ²	-18...+110° (0...+230°) Exception: Wobble stick and cat whisker devices are rated from -18...+54° (0...+130°)

AC Contact Rating (Maximum per Pole, 50 or 60 Hz, 2 Circuits Same Polarity)

NEMA Rating Designation	Max Voltage	A		Continuous Carrying Current	VA	
		Make	Break		Make	Break
A600 AC-15	120	60	6.00	10	7200	720
	240	30	3.00	10	7200	720
	480	15	1.50	10	7200	720
	600	12	1.20	10	7200	720
B600 ³ AC-15	120	30	3.00	5	3600	360
	240	15	1.50	5	3600	360
	480	7.5	0.75	5	3600	360
	600	6	0.60	5	3600	360

AC Contact Rating (Maximum per Pole, 50 or 60 Hz, 4 Circuits Same Polarity)

NEMA Rating Designation	Max Voltage	A		Continuous Carrying Current	VA	
		Make	Break		Make	Break
A300	120	60	6.00	10	7200	720
	240	30	3.00	10	7200	720

DC Contact Rating (Maximum per Pole)

Circuits	Voltage Range	Current Rating
2	115-125	0.4 A
	230-250	0.2 A
	550-600	0.1 A
4	115-125	0.4 A
	230-250	0.2 A

Plug-in Style

Lever Type • Spring Return page 5-42
Standard and Low Operating Torque Models

Lever Type • Maintained . . . page 5-44
Contact and Neutral Position

Push Type • Spring Return . . . page 5-45

Wobble Stick and Cat page 5-47
Whisker • Spring Return

Modifications and page 5-53
Accessories

802T Operating Levers

Lever Selection page 5-130

802T Lever Type • Maintained Contact and Neutral Position

Plug-in Style Oiltight Switches

Range of Operation

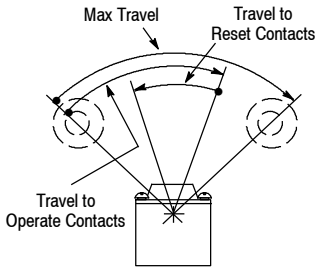

Maintained Contact Models

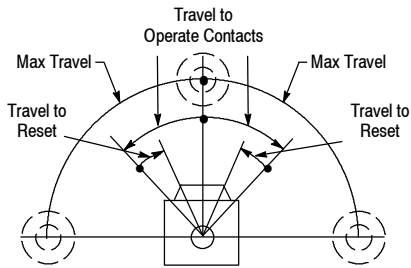

Neutral Position Models





Switch Without Lever

Switch Without Lever and Base

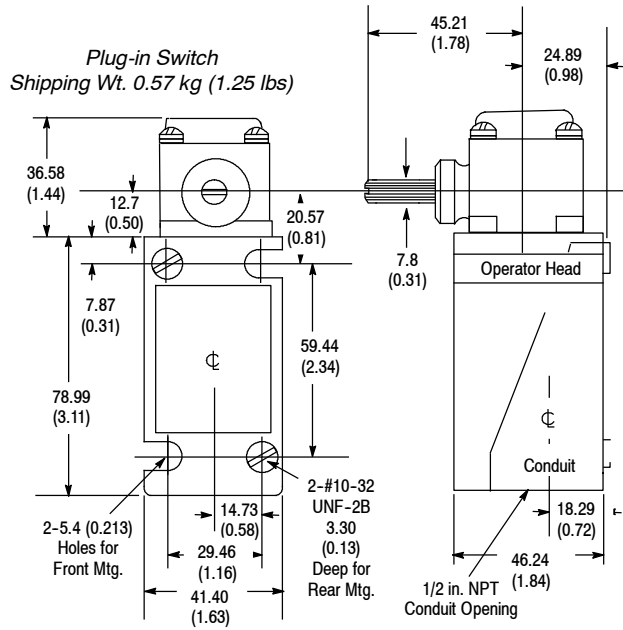
Approximate Dimensions [mm (in.)]

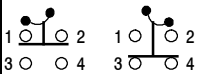

Product Selection—Maintained Contact Models

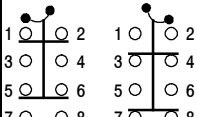
No. of Circuits	Lever Movement vs. Contact Operation	Torque to Operate (Max.)	Travel to Operate Contacts (Max.)	Max Travel	Travel to Reset Contacts (Max.)	Cat. No.	
						Switch w/o Lever	Switch w/o Lever & Base
2	Clockwise or Counterclockwise 	0.31 N•m (2.75 lb•in)	70° 	88° 	32°	802T-AMP	802T-AMP1
4	Clockwise or Counterclockwise 	0.32 N•m (2.8 lb•in)				802T-AMTP	802T-AMTP1

 From one maintained position to another.

Product Selection—Neutral Position Models

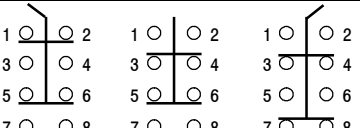
Lever Movement vs. Contact Operation	Torque to Operate (Max.)		Travel to Operate Contacts (Max.)	Max Travel	Travel to Reset Contacts (Max.)	Cat. No.	
	Clockwise	Counter-clockwise				Switch w/o Lever	Switch w/o Lever & Base
	0.28 N•m (2.5 lb•in)	0.47 N•m (4.2 lb•in)	13°	75°	7°	802T-NPTP	802T-NPTP1

Levers—See page 5-130 for a complete listing of operating levers.

Modifications and Accessories—See page 5-53.