

# 22.5 mm Push Buttons

## Product Overview



### Bulletin 800F Plastic and Metal Operators

- 22.5 mm mounting hole
- IP65/66, Type 4/4X/13
- Internationally rated operators

### Table of Contents

See below.

### TABLE OF CONTENTS

Description	Page
<b>Specifications</b> .....	10-67
<b>Quick Selection</b> .....	10-70
<b>Push Buttons, Momentary</b>	
Non-Illuminated — Flush, Extended, Guarded.....	10-73
Non-Illuminated — with Two-Color Molded Legend Caps....	10-74
Illuminated — Flush, Extended, Guarded.....	10-75
<b>Push Buttons, Alternate Action</b>	
Non-Illuminated — Flush.....	10-76
Illuminated — Flush.....	10-76
<b>Pilot Light Operators</b> .....	10-77
<b>Selector Switches</b>	
Non-Illuminated, 2-Position.....	10-78
Illuminated, 2-Position.....	10-79
Non-Illuminated, 3-Position.....	10-80
Illuminated, 3-Position.....	10-81
Non-Illuminated, 4-Position.....	10-82
<b>Key Selector Switches</b>	
2-Position .....	10-83
3-Position .....	10-84
<b>Emergency Stop Operators</b>	
Twist-to-Release and Push-Pull Mushroom Operators	
Non-Illuminated .....	10-85
Illuminated .....	10-85
Key Release Mushroom Operators .....	10-85
Push-Pull Mushroom Operator, 3-Position .....	10-89
<b>Momentary Mushroom Operators</b>	
Non-Illuminated.....	10-90
Illuminated.....	10-91

Description	Page
<b>Multi-Function Operators</b>	
2-Function, Momentary, Non-Illuminated .....	10-92
2-Function, Momentary, Illuminated .....	10-93
3-Function, Momentary, Non-Illuminated .....	10-94
<b>Reset Operators</b> .....	10-95
<b>Single-Turn Potentiometer Assembly</b>	10-96
<b>Key Operated Selector Switch — SensEject™</b> .....	10-96
<b>Selector Push Button Operators</b> .....	10-97
<b>Toggle Switch Operators</b> .....	10-98
<b>Back-of-Panel Components</b>	
Contact Blocks.....	10-99
Power Modules .....	10-99
Power Modules with Contact Blocks.....	10-100
<b>Enclosures</b> .....	10-103
<b>Assembled Stations</b> .....	10-103
<b>Assembled Stations with DeviceNet</b> .....	10-105
<b>Pendant Stations</b> .....	10-106
<b>Accessories</b>	
Miscellaneous .....	10-107
Guards .....	10-109
Locking Attachments.....	10-110
Replacement Lamps .....	10-111
Color Caps, Lenses, Diffusers without Text .....	10-112
Two-Color Molded Legend Caps.....	10-113
E-Stop Legends.....	10-113
Legend Plates.....	10-114
Custom Laser-Engraved Caps/Diffusers.....	10-115
Legend Text.....	10-116
<b>Approximate Dimensions</b> .....	10-120

### Bulletin 800FP Plastic Operators

- IP65/66, Type 4/4X/13
- Engineering grade thermoplastics
- Chemical-resistant for harsh environments



**Bul. 800FP Plastic Operators**

### Bulletin 800FM Metal Operators

- IP65/66, Type 4/13
- Die-cast metal construction
- Chrome-plated



**Bul. 800FM Die-Cast Metal Operators**



**Overview, Continued**

**3-Across x 2-Deep Back-of-Panel (6 Circuits Max.)**

- Rugged snap-fit design for plastic or metal latch
- Stackable contact blocks
- Rotating collar for easy one-hand latch removal
- Color-coded contact block plungers for contact identification



**Plastic Latch with Contact Block**



**Metal Latch with Contact Block**

**Assembly Overview**

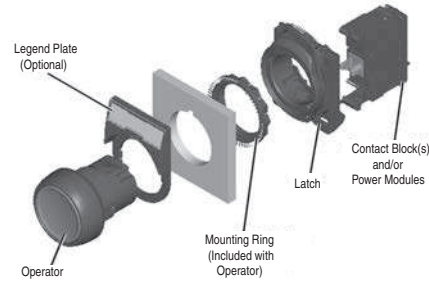

**Specifications\***

**Front-of-Panel (Operators)**

Description		Mechanical Ratings	
		Plastic (Bulletin 800FP)	Metal (Bulletin 800FM)
Vibration (assembled to panel)		Tested at 10...2000 Hz, 1.52 mm displacement (peak-to-peak) max./10 G max. for 3 hr duration, no damage	
Shock		Tested at 1/2 cycle sine wave for 11 ms; no damage at 100 G	
Degree of protection*		IP65/66 (Type 3/3R/4/4X/12/13)	IP65/66 (Type 3/3R/4/12/13)
Mechanical durability per EN 60947-5-1 (Annex C)	10 000 000 Cycles	Momentary push buttons, momentary mushroom	
	1 000 000 Cycles	Multi-function, selector switch, key selector switch, selector jog, SensEject™ key selector switch	
	500 000 Cycles	Non-illuminated push-pull E-stop‡	
	300 000 Cycles	Twist-to-release E-stop, illuminated push-pull E-stop‡, alternate action push buttons	
	100 000 Cycles	Potentiometer, toggle switch	
Operating forces (typical with one contact block)		Flush/extended = 5 N, E-stop = 36 N Mushroom = 9 N	
Operating torque (typical application with one contact block)		Selector switch = 0.25 N•m (2.2 lb•in)	
Mounting torque	Plastic	1.7 N•m (15 lb•in)	
	Metal	4.4 N•m (40 lb•in)	
Environmental			
Temperature range (operating)		-25...+70 °C (-13...+158 °F)§	
Temperature range (short term storage)		-40...+85 °C (-40...+185 °F)	
Humidity		50...95% RH from 25...60 °C (77...140 °F)	

\* Performance Data — see page Important-3 of the Industrial Controls catalog.

⊛ Momentary mushroom operators are IP65. Plastic keyed operators are IP66, Type 4/13; not Type 4X.

‡ Limit of four contact blocks max. for these devices.

§ Operating temperatures below 0 °C (32 °F) are based on the absence of freezing moisture and liquids, UL Recognized to 55 °C (131 °F) - Incandescent module max. 40 °C (104 °F).

**Product Certifications**

Certifications	UR/UL, CSA, CCC, CE
Standards Compliance — CE Marked	NEMA ICS-5; UL 508, EN ISO 13850, EN 60947-1, EN 60947-5-1, EN 60947-5-5
Terminal Identification	EN/IEC 60947-1
Shipping Approvals	ABS
RoHS	✓

**Bulletin 800F**  
**22.5 mm Push Buttons**  
**Specifications**

**Back-of-Panel Components\***

Electrical Ratings			
Standard contact block ratings	A600, Q600 600V AC AC 15, DC 13 to IEC/EN 60947-5-1 and UL 508, 17V, 5 mA min.		
Low voltage contact block ratings*	5V, 1 mA DC min. C300, R150, AC 15, DC 13 to EN 60947-5-1 and UL 508		
	<b>Nominal Voltage</b>	<b>Range</b>	<b>Current Draw</b>
LED Module Ratings	24...120V AC/DC	20...132V AC/DC	15 mA (AC), 12 mA (DC)
	24V AC	10...29V AC	31 mA
	24V DC	10...30V DC	24 mA
	120V AC	102...132V AC	6 mA
	240V AC	204...264V AC	6 mA
Frequency	50/60 Hz, DC		
Thermal current	10 A max. enclosed (40 °C ambient) to UL508, EN 60947-5-1		
Insulation voltage (U <sub>i</sub> )	Screw terminal = 690V, spring-clamp = 300V		
Wire capacity (screw terminal)‡	#18...12 AWG (0.75...2.5 mm <sup>2</sup> ) Max. (2) #14 AWG or (1) #12 AWG		
Wire capacity (spring-clamp terminal)	#18...14 AWG (0.75...1.5 mm <sup>2</sup> ) One per spring clamp, two spring clamps per terminal		
Recommended tightening torque on screw terminals	0.7...0.9 N•m (6...8 lb•in)		
Dielectric strength (minimum)	2500V for one minute		
External short circuit protection	Standard blocks	10 A type gL/gG cartridge fuse to EN 60269-2-1 or gN (Class J to UL 248-8 or Class C to UL 248-4)	
	Low voltage contact blocks	6 A type gL/gG cartridge fuse to EN 60269-2-1 or gN (Class J to UL 248-8 or Class C to UL 248-4)	
Electrical shock protection	Finger-safe conforming to IP2X		
Mechanical Ratings			
Vibration (assembled to panel)	Tested at 10...2000 Hz, 1.52 mm displacement (peak-to-peak) max./10 G max. 6 hr		
Shock	Tested at 1/2 cycle sine wave for 11 ms and no damage at 100 G max.		
Contact durability per EN 60947-5-1 (Annex C)	10 000 000 cycles		
Contact operation	N.O.	Slow double make and break	
	N.C. & S.M.C.B.	Slow double make and break — positive opening ⊖	
	N.O.E.M.	Double break / double make, early make	
	N.C.L.B.	Double break / double make, late break — positive opening ⊖	
	N.C.E.B.	Double break / double make, early break — positive opening ⊖	
Push button travel to change electrical state	N.C. and N.O.E.M.	1.5 mm (0.060 in.)	
	N.O. and N.C.L.B.	2.5 mm (0.1 in.)	
Operating forces (typical)	Single circuit contact block	3.4 N	
	Dual circuit contact block	5...6.5 N	
Illumination			
LED Dominant Wavelength	Green	525 nm	
	Red	629 nm	
	Yellow	590 nm	
	Blue	470 nm	
	White	—	
LED Luminous Intensity	Green	780 mcd	
	Red	780 mcd	
	Yellow	600 mcd	
	Blue	168 mcd	
	White	360 mcd	
Incandescent maximum wattage	2.6 W		
Materials			
Springs	Stainless steel and zinc coated music wire		
Electrical contacts	Standard	Silver-nickel	
	Low voltage	Gold-plated over silver	
Terminals	Screw	Brass	
	Spring-clamp	Silver-plated brass	

\* Performance Data — see page Important-3 of the Industrial Controls catalog.

\* Low voltage contacts are recommended for applications below 17V, 5 mA.

‡ Wires less than #18 AWG (0.75 mm<sup>2</sup>) may not hold in terminal securely.



**Material Listing**

Component	For Use with	Material Used
Panel gasket	All operators	Nitrile, TPE
Diaphragm seal	Illuminated push button, non-illuminated push button	Automotive industry acceptable silicone
K-seal	Selector switch, key selector switch, push/twist-to-release E-stop, key E-stop, push/pull mushroom	Nitrile
Diaphragm retainer, return spring I	Illuminated push button, non-illuminated push button, momentary mushroom	Stainless steel
Return spring II	Reset, selector switch, key selector switch, alternate action, push/twist-to-release E-stop, key E-stop, push/pull mushroom	Zinc-coated music wire
Button cap/mushroom head	Non-illuminated push button, momentary mushroom, reset, push/twist-to-release E-stop, key E-stop, push/pull mushroom, multi-function	PBT/polycarbonate blend
2-color molded button cap	Non-illuminated push button	PBT/polycarbonate blend
Lens	Multi-function	Acetal
Lens, knob	Illuminated push button, illuminated momentary mushroom, illuminated selector switch	Polyamide
Knob	Non-illuminated selector switch	Glass-filled polyamide
Plastic bezel/bushing I	Non-illuminated push button, illuminated push button, momentary mushroom, selector switch, key selector switch, push/twist-to-release E-stop, key E-stop, push/pull mushroom, multi-function, reset	Glass-filled polyamide
Plastic bezel/bushing II, jam nut	Pilot light, reset jam nut, reset pushers	Glass-filled PBT
Metal bezel/bushing	All metal operators	Zinc
Diffuser	Illuminated push button, pilot light	Polycarbonate
Legend frames	—	Glass-filled polyamide
Plastic mounting ring	All plastic operators	Glass-filled polyamide
Metal mounting ring	All metal operators	Chromated zinc
Plastic latch	—	Glass-filled polyamide
Metal latch	—	Chromated zinc + stainless steel
Plastic enclosure	—	PBT/polycarbonate blend
Metal enclosure	—	Aluminum
Terminal screws	LED module, incandescent module, contact blocks	Zinc-plated steel with chromate
Terminals	LED module, incandescent module, contact blocks	Brass with silver-nickel contacts
Spring clamps	LED module, incandescent module, contact blocks	Stainless steel
Lamp socket	Incandescent module	Brass
Housing	Incandescent module, LED module	Glass-filled polyamide
Low-voltage terminals	Contact blocks	Gold-plated silver-nickel contacts
Low-voltage spanner	Contact blocks	Gold-plated silver-nickel contacts
Spanner	Contact blocks	Brass with silver-nickel contacts
Boot	Toggle Switch, illuminated push button, non-illuminated push button, multi-function illuminated and non-illuminated	Automotive industry acceptable silicone

Momentary Push Button Operators, Illuminated — Flush, Extended, Guarded



Flush Operator  
 Cat. No. 800FM-LF4



Extended Operator  
 Cat. No. 800FP-LE3



Guarded Operator  
 Cat. No. 800FP-LG3

Color	Pkg. Quantity	Flush		Extended	
		Plastic	Metal	Plastic	Metal
		Cat. No.	Cat. No.	Cat. No.	Cat. No.
Green	1	800FP-LF3	800FM-LF3	800FP-LE3	800FM-LE3
Red		800FP-LF4	800FM-LF4	800FP-LE4	800FM-LE4
Yellow		800FP-LF5	800FM-LF5	800FP-LE5	800FM-LE5
Clear		800FP-LF7	800FM-LF7	800FP-LE7	800FM-LE7

800F  P  -  LE   3  -    
           a          b          c          d

**a**

Operator Construction	
Code	Description
P	Round plastic operator (IP66, Type 4/4X/13)
M	Round metal operator (IP66, Type 4/13)

**c**

Color Cap *	
Code	Color
0	Amber*
3	Green
4	Red
5	Yellow*
6	Blue*
7	Clear
9	No cap

**d**

Packaging	
Code	Description
Blank	1 per package
BP	10 per package†

**b**

Operator Type	
Code	Description
LF	Flush
LE	Extended
LG	Guarded

\* For custom laser-engraved operator, order operator with applicable lens cap color plus custom laser-engraved diffuser; see page 10-115.  
 \* When using LED for illumination, a white LED is recommended.  
 † Only available with no color cap (9 from Table c).

**Push-to-Test Push Button Device Schematic**

Illuminated push buttons may be wired as a push-to-test device by using the following schematic and Cat. No. 800F-XD7 Diode module from page 10-111.

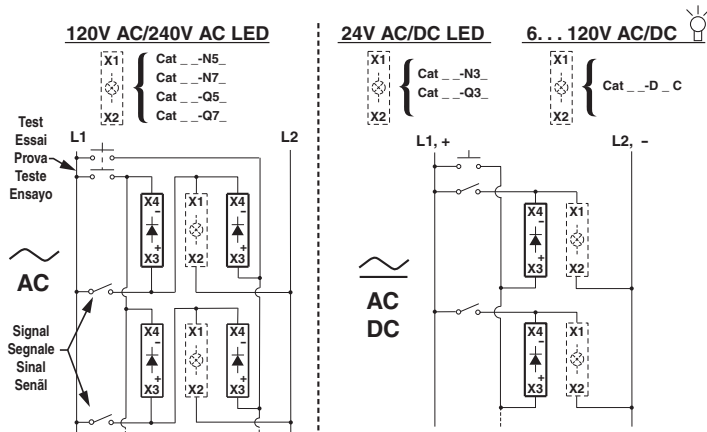

# 22.5 mm Push Buttons

## Approximate Dimensions

### Approximate Dimensions

Dimensions in millimeters. Dimensions are not intended to be used for manufacturing purposes. Refer to RAISE software for additional dimensional information.

#### Non-Illuminated and Illuminated Momentary Flush Push Button Operators

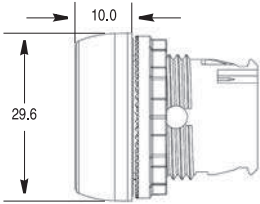

#### Illuminated Momentary Guarded Push Button Operators

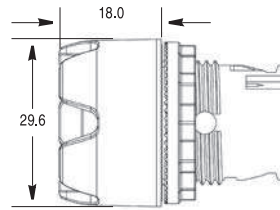

#### Illuminated and Non-Illuminated Momentary Extended Push Button Operators

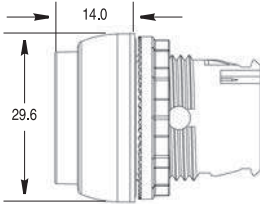

#### Reset Operators with Reset Rod

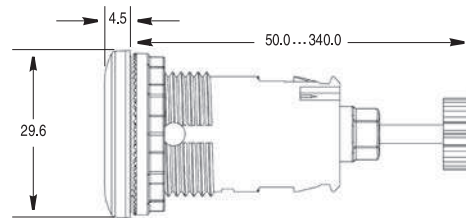

#### Non-Illuminated Guarded, Illuminated and Non-Illuminated Alternate Action Push Button Operators

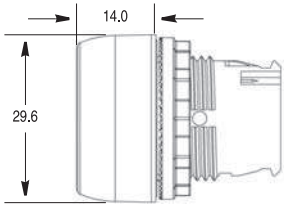

#### Pilot Light Operators

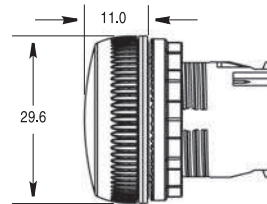

#### 90 mm Half Dome

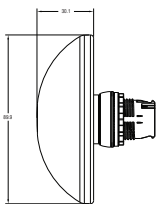

#### 90 mm Mushroom

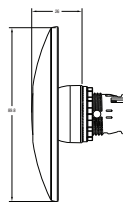

#### Illuminated and Non-Illuminated Momentary Mushroom Operators 40 mm and 60 mm

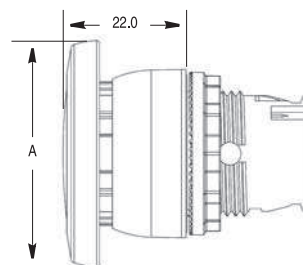

Operator	A
40 mm	39.8
60 mm	59.8

#### Toggle Switch Operators

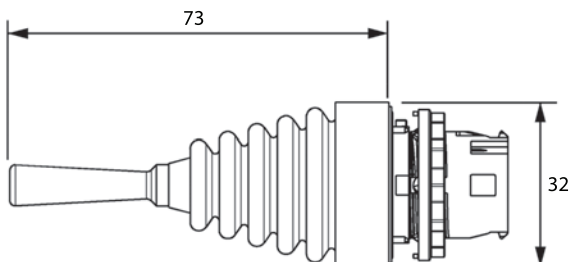

#### Selector Jog Operators

