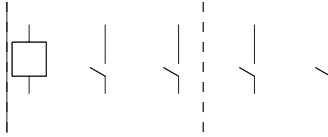
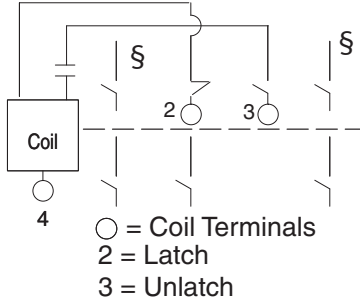
	<p>Bulletin 700-N — Industrial Relay</p> <ul style="list-style-type: none"> • Contact cartridges convertible from N.O. to N.C. and vice versa • NEMA A300 AC • 24...250V AC coils • Pneumatic timing unit • Solid-state timing unit • Overlap contacts • Logic reed contacts • 4...8-pole 	<p>Table of Contents</p> <p>Product Selection this page</p> <p>Accessories..... 9-133</p> <p>Specifications..... 9-138</p> <p>Approximate Dimensions..... 9-135</p> <p>Standards Compliance and Certifications</p> <p>cULus Listed (File No. E14840, Guide NKCR/NKCR7) per UL 508</p> <p>CSA C22.2 No. 14</p>
---	--	---

AC-Operated Relays

	Contacts* ❄		Contact Arrangement	Open Type
	N.O.	N.C.		Cat. No.
	4	—	4-Pole Relay 	700-N400❉
Type NM Relay 2 Poles ‡	2	—	 <p>○ = Coil Terminals 2 = Latch 3 = Unlatch</p>	700-NM200❉

❉ **AC Coil Voltage Code**

The Cat. No. as listed is incomplete. Select a coil voltage code from the table below to complete the cat. no. Example: **Cat. No. 700-N200❉** becomes **Cat. No. 700-N200A24** for 24V 60 Hz. For other coil voltages, contact your local Rockwell Automation sales office or Allen-Bradley distributor.

[V]	24	110	120	208	220	240
50 Hz	—	A1	—	—	A2	—
60 Hz	A24	—	A1	A20	—	A2

* **NORMALLY CLOSED CONTACTS:** Listed relays are supplied with all contacts normally open. These contacts can be readily converted to normally closed in the field.

❄ **OVERLAP CONTACTS:** Overlap contacts (normally open contact closes before the normally closed contact opens) can be supplied. See page 9-133 for information on kits for field installation of overlap contact cartridges.

§ Location of contacts in 2-pole relays

‡ Permanent Magnet Latch AC Relay. Minimum Operating Time - Type NM - For reliable operation, power to the latch circuit **must be** maintained for a minimum time of 75 milliseconds and power to the unlatch circuit **must be** maintained for minimum time of 50 milliseconds.

Operating Coils

 <p>Bulletin 700-N Operating Coil</p>	Bulletin 700-N Relay • 2...8-Pole		
	Coil Voltage	60 Hz	50 Hz
	24	84AB27	84AB28
	110	84AB01	84AB86
	120	84AB86	—
	208	84AB113	—
	220	84AB06	84AB83
	240	84AB83	—

Bulletin 700-NT Pneumatic Timing Unit

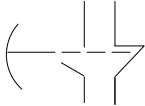
 Cat. No. 700-NT	Description	Timed Contacts		Contact Arrangement	Open Type
		N.O.	N.C.		Cat. No.
	Timing Unit Only (for Bulletin 700-N, 2...4-pole)	1	1	ON-Delay mode is standard. Timer is easily converted to OFF-Delay mode.	700-NT











Bulletin 852S Solid-State Timing Unit for Mounting on Bulletin 700-N Relays*

(Supplied as On-Delay. Easily Converted to Off-Delay Mode) Input: 110V/50 Hz, 120V/60 Hz; Output: NEMA B300, Sealed Contacts

Timing Unit with Self-Contained Potentiometer		
Minimum Time [s]	Minimum Time [s]	Cat. No.
0.1	5.0	852S-NSA
0.5	30.0	852S-NSB
1.0	60.0	852S-NSC

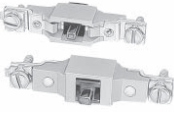
Timing Unit Only			External Potentiometer	
Minimum Time [s]	Maximum Time [s]	Cat. No.	Resistance	Cat. No.
0.1	0.21	* 852S-A*	15 kΩ	800T-U34
	0.35		25 kΩ	800T-U37
	0.70		50 kΩ	800T-U41
	1.10		75 kΩ	800T-U46
	1.50		100 kΩ	800T-U49
	2.10		150 kΩ	800T-U50
	5.6		400 kΩ	800T-U54
	7.0		500 kΩ	800T-U55
	14.0		1 MΩ	800T-U57
	29.0		2 MΩ	800T-U59
1.0	2.0	852S-C	50 kΩ	800T-U41
	4.0		100 kΩ	800T-U49
	8.0		200 kΩ	800T-U51
	16.0		400 kΩ	800T-U54
	32.0		800 kΩ	800T-U56
	40.0		1 MΩ	800T-U57
	80.0		2 MΩ	800T-U59
	120.0		3 MΩ	800T-U62
	160.0		4 MΩ	800T-U64

* The maximum time is fixed by component characteristics and may be up to 70% greater than listed
 * These timing relays require an external potentiometer. To order an external potentiometer, refer to right side of table.

	Description		Cat. No.
 Universal Mounting Strip	Relay Rail Simplifies panel layout. These indexed strips are easily cut to the required length and bolted, riveted, or spot-welded in place. Relays are installed adjacent to one another on the mounting strip with the captive mounting screws provided. Rows of relays on Relay Rail form their own wiring trough. Can be used with the following relays: 700P, 700-PK, 700PH, 700S-P, 700N, 700-R, 700-RTC	Relays per strip 4 8 12 16	700-MP4 700-MP8 700-MP12 700-MP16
 Cat. No. 700-DRA	DIN Rail Adapter	—	700-DRA
 Cat. No. 700-NA00	Front Deck Front decks can be attached to Bulletin 700 4-pole relays. Provides up to 4 additional convertible poles – without changing the mounting area.	Front Deck without Contact Cartridges	700-NA00
 Cat. No. 700-NA00	Standard Contact Cartridges Available for adding to both rear deck and front deck.	Rear Deck Contact Cartridge Front Deck Contact Cartridge	* 700-C1 * 700-C2
 Cat. No. 700-NA00	Gold-Plated Contact Cartridges May be used in low power circuits to improve reliability. Good for long term storage, because gold resists corrosion.	Rear Deck Contact Cartridge Front Deck Contact Cartridge	* 700-C1X * 700-C2X
 Cat. No. 700-NA00	Logic Reed Cartridges Cartridges are hermetically sealed contact for low energy switching.	Rear Deck Contact Cartridge (150V AC, 150 mA, 8VA Max.) (30V DC, 60 mA Max.)	* 700-C1R
 Cat. No. 700-NA00	Bifurcated Contact Cartridges Cartridges are less apt to open because of vibration and shock.	Rear Deck Contact Cartridge Front Deck Contact Cartridge	* 700-C1B * 700-C2B
 Cat. No. 700-C11Z	Overlap Contact Cartridges Cartridges are available in pairs. The N.O. contact closes before the N.C. contact opens. 300V AC max. 125V DC max.	Rear Deck Contact Cartridge (1 pair in a package) Front Deck Contact Cartridge (1 pair in a package)	* 700-C11Z * 700-C22Z
Timing Unit Replacement (Bifurcated) Contact Cartridge for Bulletin 700-NT relay		Timing Unit Deck Contact Cartridge	* X-457011
 Cat. No. 700-N4,-N3	Jumpers (Not applicable for Bulletin 700-PH or -PK relays) – For connection between a middle pole and an outer pole on the left or right side of the relay.	Jumper for middle pole to outer poles Jumper for middle poles	700-N3 700-N4
Gold-Plated Contact Timing Unit Replacement Cartridge		—	* 40163-447-03
 Cat. No. 700-N5 Cat. No. 700-N24	Surge Suppressors (RC Circuit) — Surge suppressors reduce the high transient voltages generated when the coil circuit is opened. These suppressors can be used with Bulletin 700-P, -PH, -PK, and -N relays, and other electromechanical devices. They contain a resistor and capacitor. Maximum ratings: 150V, AC or DC, 35 VA. Cat. No. 700-N5 requires 1 in. additional depth of enclosure.	For mounting behind relay (1 in. additional depth needed) For mounting on coil terminal	700-N5 700-N24
 Cat. No. 700-N21	Check Out Tool Mechanically maintains the Bulletin 700-N relay in operated position.	Check Out Tool for Bulletin 700-N AC relay	700-N21

* All contact cartridges are convertible (N.O. or N.C.).

Bulletin 700-N
Industrial Relays
 Specifications

		Bul. 700-N	Bul. 700-NT
Electrical Ratings			
Rated Thermal Current I_{th}		10 A	
Rated Insulation Voltage		300V	
Contact Rating		10 A @ 300V AC, NEMA A300	
Coil Voltage Range	AC	85...110%	—
	DC	80...110%	—
Coil Consumption			
		50 Hz	60 Hz
AC	Inrush	120 VA	133 VA
	Sealed	24 VA	20 VA
Mechanical			
		AC	—
Max. Operating Time	Pickup	14 ms	—
	Drop Out	13 ms	—
Timing Range		—	0.2...60 s
Repeat Accuracy		—	±15% of setting
Reset Time		—	75 ms
Timing Mode		—	On-Delay — convertible to OFF Delay, up to 2 poles convertible to N.O. or N.C.
Construction			
Contact Arrangement		Up to 8 Poles, Convertible to N.O. or N.C.	—
Contact Material		Silver	Silver
Mounting		Panel or strip mount Horizontal mounting recommended	On relay only
Environmental			
Ambient Temperature (Outside Enclosure)	Operating	-20...+40 °C (-4...+104 °F)	
	Storage	-40...+60 °C (-40...+140 °F)	
Operating Temperature Rise (Inside Enclosure)		+25 °C Max	—
Wire Terminations			
Wire size per UL/CSA		#18 AWG...(2) #12 AWG	
Tightening Torque		8...12 lb•in. (0.9...1.4 N•m)	

Approximate Dimensions

Dimensions are shown in millimeters (inches). Dimensions are not intended to be used for manufacturing purposes.

Type of Relay	No. of Poles	Drawing Number	Open Type Without Enclosure				Approx. Ship. Wt. kg (lbs.)	Type 1 General Purpose Enclosure					Approx. Ship. Wt. kg (lbs.)	
			A Wide	B High	C Deep	D		A Wide	B High	C Deep	D	E		
N	Bulletin 700	2...4	1	57.15 (2-1/4)	88.90 (3-1/2)	82.55 (3-1/4)	79.38 (3-1/8)	0.68 (1-1/2)	107.95 (4-1/4)	185.74 (7-5/16)	103.19 (4-1/16)	146.05 (5-3/4)	85.73 (3-3/8)	1.59 (3-1/2)
	Bulletin 700	6...8	2	57.15 (2-1/4)	88.90 (3-1/2)	106.36 (4-3/16)	79.38 (3-1/8)	0.79 (1-3/4)	112.71 (4-7/16)	228.60 (9)	120.65 (4-3/4)	206.38 (8-1/8)	92.08 (3-5/8)	2.27 (5)
N with Pneumatic Timer	Bulletin 700	2...4	3	57.15 (2-1/4)	88.90 (3-1/2)	138.11 (5-7/16)	79.38 (3-1/8)	0.91 (2)	—	—	—	—	—	—
N with Solid-State Timer	Bulletin 700	2...4	3	57.15 (2-1/4)	88.90 (3-1/2)	160.34 (6-5/16)	79.38 (3-1/8)	1.02 (2-1/4)	—	—	—	—	—	—

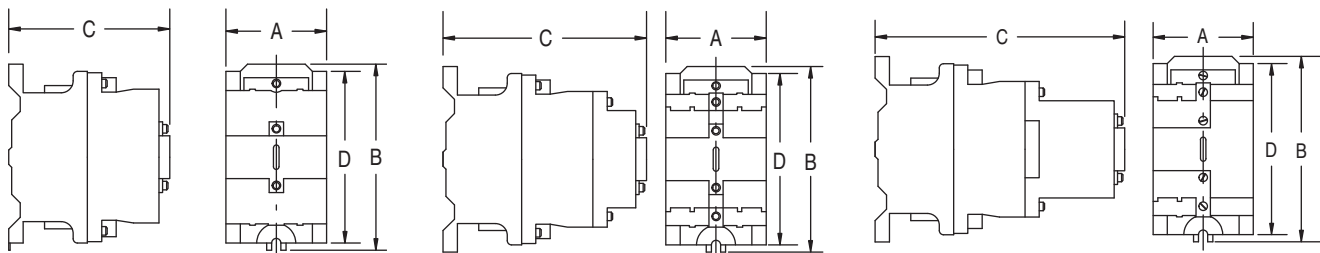

Drawing Number 1

Drawing Number 2

Drawing Number 3

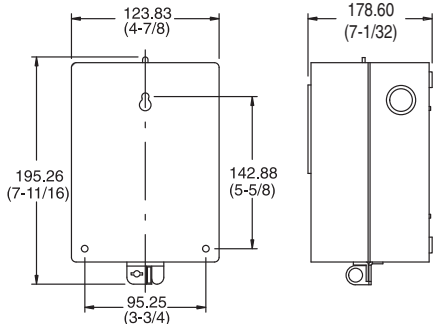

Type 1 Enclosure

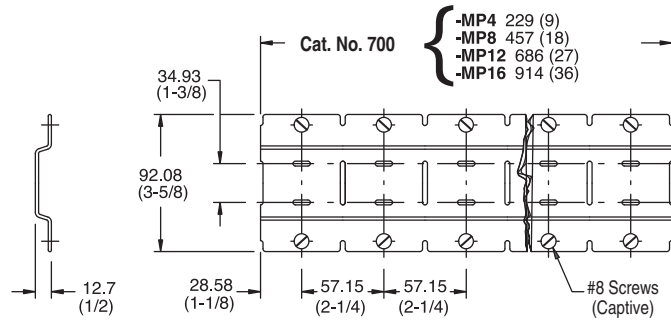

Relay Rail for Bulletin 700-P, -PH, -PK, -N, -NM, -R, -RM, -RT, -RTA Relays

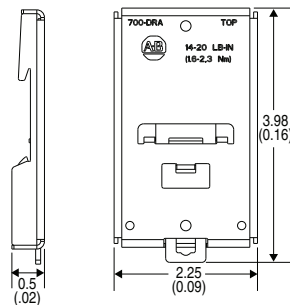
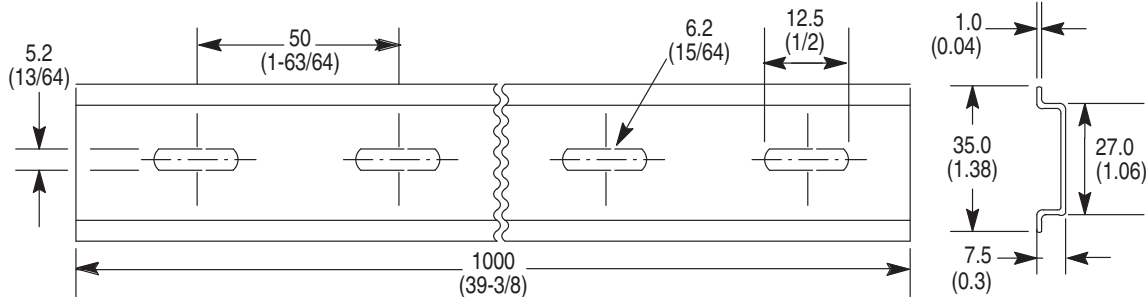

DIN Rail Adapter