

Bulletin 700-HA — Tube Base Relay

- 10 A contact rating
- DPDT, 3PDT
- Pin-style terminals
- Standard ON/OFF flag indicator
- Options: LED, push-to-test and manual override, socket-mounted surge suppressor module, or multi-function timer
- Contact choices: standard silver nickel, bifurcated silver nickel, or bifurcated with gold plating

Table of Contents

Product Selection..... this page

Accessories..... 9-11

Specifications..... 9-9

Approximate Dimensions..... 9-17

Product Selection

Bulletin 700-HA Tube Base Relay with PIN Terminals (Single Contact) — Mechanical ON/OFF Indicator included*

	Description	Contact Rating	Wiring Diagrams		Coil Voltage	Cat. No. * ‡ §
			U.S./Canada	International		
	DPDT 2-pole 2 Form C Single AgNi Contact	10 A B300			6V AC	700-HA32A06
					12V AC	700-HA32A12
					24V AC	700-HA32A24
					120V AC	700-HA32A1
					240V AC	700-HA32A2
					277V AC	700-HA32A27 ➤
					6V DC	700-HA32Z06
					12V DC	700-HA32Z12
					24V DC	700-HA32Z24
					36V DC	700-HA32Z36
					48V DC	700-HA32Z48
					60V DC	700-HA32Z60
					80V DC	700-HA32Z80
					110V DC	700-HA32Z1
					125V DC	700-HA32Z01
140V DC	700-HA32Z3					
220V DC	700-HA32Z2 ➤					
	3PDT 3-pole 3 Form C Single AgNi Contact	10 A B300			6V AC	700-HA33A06
					12V AC	700-HA33A12
					24V AC	700-HA33A24
					120V AC	700-HA33A1
					240V AC	700-HA33A2
					6V DC	700-HA33Z06
					12V DC	700-HA33Z12
					24V DC	700-HA33Z24
					48V DC	700-HA33Z48
					60V DC	700-HA33Z60
					80V DC	700-HA33Z80
					110V DC	700-HA33Z1
					125V DC	700-HA33Z01
					140V DC	700-HA33Z3
					220V DC	700-HA33Z2 ➤

* For Time Module and Surge Suppressor Module, see page 9-12.







‡ LED Option: Add suffix (-4) to the selected Bulletin 700-HA Relay Cat. No., except for the 240V AC Units, add (-4L).

‡ Push-to-test, Manual Override, and LED Option: Add suffix (-3-4) to the selected Bulletin 700-HA Relay Cat. No., except for the 240V AC units, add (-3-4L).

§ Push-to-test and Manual Override option: Add suffix (-3) to the selected Bulletin 700-HA relay.









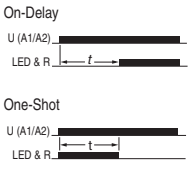

➤ LED not available for 220V DC and 277V AC coils.

Accessories

	Description	Pkg. Qty.	Cat. No.
 Cat. No. 700-HN100	Screw Terminal Tube Base Socket — Panel or DIN Rail Mounting; Guarded Terminal Construction. 8-Pin for use with DPDT Bulletin 700-HA Relays, -HX Timing Relays, -HT (On-Delay) and -HRM, -HRC and -HV (Repeat Cycle) Timing Relays.	10	700-HN100
 Cat. No. 700-HN125	Screw Terminal Tube Base Socket — Panel or DIN Rail Mounting; Open Style Construction. 8-Pin for use with DPDT Bulletin 700-HA Relays, -HT (On-Delay) and -HRM, -HRC, and -HV (Repeat Cycle) Timing Relays. No retainer clip required.	10	700-HN125
 Cat. No. 700-HN101	Screw Terminal Tube Base Sockets — Panel or DIN Rail Mounting; Guarded Terminal Construction. 11-pin for use with 3PDT 700-HA relays.	10	700-HN101
 Cat. No. 700-HN126	Screw Terminal Tube Base Sockets — Panel or DIN Rail Mounting; Open Style Terminal Construction. 11-pin for use with 3PDT 700-HA relays. No retainer clip required.	10	700-HN126
 Cat. No. 700-HN205	8-Pin Socket — Can Be Used With or Without Timing Attachment or Surge Suppressor Screw Terminal Tube Base Sockets — panel or DIN Rail mounting. Guarded terminal construction. Used with DPDT Bulletin 700-HA Relays.	10	700-HN204
	11-Pin Socket — Can Be Used With or Without Timing Module or Surge Suppressor. Screw Terminal Tube Base Sockets — panel or DIN Rail mounting. Guarded terminal construction. Used with 3PDT Bulletin 700-HA relays.	10	700-HN205
 Cat. No. 199-DR1	DIN (#3) symmetrical hat rail 35 x 7.5 x 1 m	10	199-DR1

General Purpose Relays

Accessories

	Description	Pkg. Qty.	Cat. No.			
	Diode Surge Suppressor* Voltage Range: 6...220V DC used with 700-HN204 and 700-HN205 socket	10	700-ADR			
	Diode with LED Surge Suppressor* Voltage Range: 6...24V DC used with 700-HN204 and 700-HN205 socket	10	700-ADL1R			
	Diode with LED Surge Suppressor* Voltage Range: 28...60V DC used with 700-HN204 and 700-HN205 socket	10	700-ADL2R			
	Diode with LED Surge Suppressor* Voltage Range: 110...220V DC used with 700-HN204 and 700-HN205 socket	10	700-ADL3R			
	Varistor with LED Surge Suppressor* Voltage Range: 6...24V AC used with 700-HN204 and 700-HN205 socket	10	700-AV1R			
	Varistor with LED Surge Suppressor* Voltage Range: 110...240V AC used with 700-HN204 and 700-HN205 socket	10	700-AV3R			
	RC Surge Suppressor* Voltage Range: 6...24V AC/DC used with 700-HN204 and 700-HN205 socket	10	700-AR1			
	RC Surge Suppressor* Voltage Range: 110...240V AC/DC used with 700-HN204 and 700-HN205 socket	10	700-AR2			
	Timing Module On-Delay or One-Shot selectable voltage range: 12...24V AC/DC used with sockets that accept plug-in accessory modules.		700-AT3			
	Timing Module On-Delay or One-Shot selectable voltage range: 110...125V AC used with sockets that accept plug-in accessory modules.		1	700-AT3A1		
	Timing Module On-Delay or One-Shot selectable voltage range: 230...240V AC used with sockets that accept plug-in accessory modules.			700-AT3A2		
	Multi-Function Multi-Range Time Module* Voltage range 12...240V AC 50/60 Hz and 12...240V DC, with a voltage variation of 85...110%. Repeat accuracy of ±1%. Reset time <50 ms. Refer to [T-301977] for Specifications.	Eight Timing Modes Seven Timing Ranges as follows:	1	700-HT3		
	1. 1 s				0.05 s...1 s	
	2. 10 s				0.5 s...10 s	
	3. 100 s				5 s...100 s	
	4. 10 min				0.5 min...10 min	
	5. 100 min				5 min...100 min	
	6. 10 hours				0.5 h...10 h	
	7. 100 hours				5 h...100 h	
8. LED Indicator						

* Suppressors and Time Modules easily plug into sockets (Cat. Nos. 700-HN204 and 700-HN205). For use with Bulletin 700-HA relays.

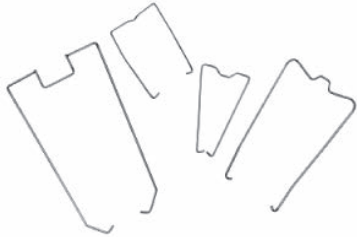
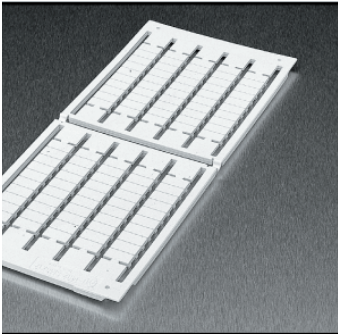
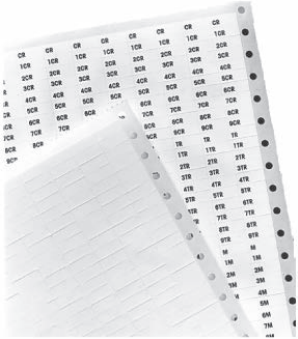
	Description	Pkg. Qty.	Cat. No.						
 <p style="text-align: center;">Sample Retainer Clips</p>	<p>Retainer Clip for Cat. Nos. 700-HN100, -HN101, -HN204, and -HN205 Sockets with Bulletin 700-HA Relays* Secures relay in socket.</p>	10	700-HN157						
 <p style="text-align: center;">Snap-in markers</p>	<p>Relay Identification Snap-in Markers† Snap-in markers fit on top of product covers. Squares slip into molded slot on top of product cover.</p>	5	<table border="1" style="width: 100%; border-collapse: collapse;"> <tr><td style="text-align: center;">1492-MS5X12</td></tr> <tr><td style="text-align: center;">1492-MS6X9</td></tr> <tr><td style="text-align: center;">1492-MS6X12</td></tr> <tr><td style="text-align: center;">1492-MS8X9</td></tr> <tr><td style="text-align: center;">1492-MS8X12</td></tr> <tr><td style="text-align: center;">1492-MP-Blank</td></tr> </table>	1492-MS5X12	1492-MS6X9	1492-MS6X12	1492-MS8X9	1492-MS8X12	1492-MP-Blank
1492-MS5X12									
1492-MS6X9									
1492-MS6X12									
1492-MS8X9									
1492-MS8X12									
1492-MP-Blank									
	<p>Pre-Printed Identification Tags — contains 10 sheets of pre-printed and blank tags. Each sheet contains 13 sets of the markings CR...9CR, TR...9TR, M...9M, F, R, 1S, and 117 blank tags. Tags are peel-off with sticky backing for easy placement on relays.</p> <p>Blank Identification Tags — contains 10 sheets of blank identification tags for customer specialized printing. Each sheet contains 546 blank tags. Tags are peel-off with sticky backing for easy placement on relays.</p>	10	700-N40						

* See Bulletin 700-HA Relay, Socket, and Retainer Clip Reference Chart below.

† For pre-printed marker cards, turn to the following 1492 sections (tab 12, under IEC Terminal Block Accessories): 1492-SM5X12_, 1492-SM6X9_, 1492-SM8X9_, 1492-SM8X12_, 1492-MP_.

Relay Type	Socket	Retainer Clip
700-HA32 700-HAB2 700-HAX2	700-HN100 700-HN125 700-HN204 700-HN200	700-HN157 Not Required§ 700-HN157 700-HN157
700-HA33 700-HAB3 700-HAX3	700-HN201 700-HN101 700-HN126 700-HN205	700-HN157 700-HN157 Not Required§ 700-HN157

§ Design of these sockets holds the relays securely and does not require retainer clips.

Bulletin 700-HA
General Purpose Relays
Specifications

Cat. No. 700-HA...			
Electrical Ratings			
Pilot Duty Rating*	NEMA B300		
Rated Thermal Current (I_{th})	HA = 10 A – 120V, 240V HAX = 6 A – 120V, 240V		
Rated Insulation Voltage (U _i)	250V IEC – 300V UL/CSA		
Contacts	Inductive	Make	Break
		▶][◀	◀][▶
	120V AC	30 A	3 A
	240V AC	15 A	1.5 A
	General Purpose	10 A, 240V AC	
	Resistive	10 A, 30V DC	
Min. Low Energy Permissible Load	HA = 10V, 5 mA HAX = 5V, 2 mA		
Permissible Coil Voltage Variation	Pickup: 80...110% of Nominal Voltage at 50 Hz 80...110% of Nominal Voltage at 60 Hz 80...110% of Nominal Voltage at DC		
Coil Consumption ±10%	AC Coils	50 Hz	60 Hz
	Inrush	3.3 VA	2.85 VA
	Sealed	2.2 VA	1.9 VA
	DC Coils	1.3 W	
Must Dropout Voltage	20% of nominal V AC 10% of nominal V DC		
Max. Contact Resistance	50 MΩ (700-HA and 700-HAB) 30 MΩ (700-HAX)		
Design Specification/Test Requirements			
Electrical			
Pole-to-Pole	1000V		
Contact to Coil	3600V		
Contact to Frame	4000V		
Electrical Life (Operating)	100 000 min.		
Mechanical			
Degree of Protection (Open Type) IEC 529	IP 40		
Mechanical Life Cycles (AC/DC)	> 20 x 10 ⁶ / 50 x 10 ⁶		
Switching Frequency Operations	3600/HR		
Coil Voltages	See Product Selection		
Operating Time	Max. Pickup	10 ms	
	Max. Dropout	10 ms	
Maximum Operating Rate	4 Ops/s		
Vibration	Endurance	5 G	
	Operational	2.5 G	
Shock	Endurance	50 G	
	Operational	9 G	
Environmental			
Temperature	Operating	AC/DC	-40...+70 °C
	Storage	AC/DC	-40...+100 °C
Altitude	2000 m (6560 ft)		
Construction			
Insulating Material	Molded High-Dielectric Material		
Enclosure	Transparent Dust Cover		
Contact Material	700-HA:	10 A– AgNi	
	700-HAX:	6 A–Bifurcated/Gold Plating AgNi	
Terminal Markings on Socket	In accordance with EN50 0005		
Sockets	8-Pin Socket — 700-HN100, -HN125, -HN204 11-Pin Socket — 700-HN101, -HN126, -HN205		
Certifications	cURus Recognized (File No. E3125, Guide NLDX2/NLDX8), cULus Listed when used with Bulletin 700-HN sockets noted above (File No. E3125, Guide NLDX/NLDX7), CE Marked, CSA Certified, UR Certified (File 229473)		
Standards	UL508, CSA C22.2 No. 14, EN 61810-1, EN 60255-23		

* Performance Data – See this catalog, Important- 3.

* NEMA Rating Chart is in publication 700-SG003*



700-HA Relay Performance Graphs

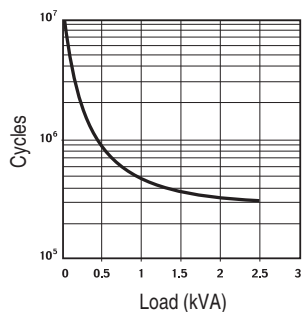

Contact life vs. AC1 load at 1,800 cycles/h

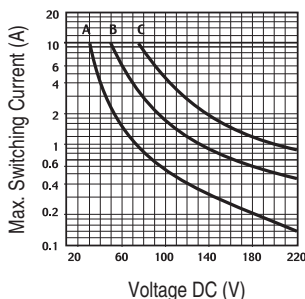

Breaking capacity for DC1 load at 1,800 cycles/h.

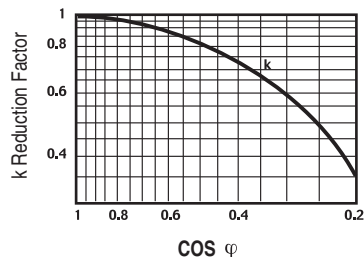

Load reduction factor vs. $\cos \phi$

A = load applied to one contact
B = load applied to two contacts in series
C = load applied to three contacts in series

Time Module Cat. No. 700-HT3		
Electrical Ratings		
Operating Voltage Range	12...240V AC (50/60 Hz) 12...240V DC	
Power Consumption	0.1 W (12V) 1.0 W (230V)	
Mechanical		
Degree of Protection of Input (B1) Terminal	IP 20 (Guarded Terminal)	
Input Terminal Wire Range	1.0 x 0.2 mm ² ...2.5 mm ² (24 AWG...14 AWG) 2.0 x 0.2 mm ² ...1.5 mm ² (24 AWG...16 AWG)	
Input Terminal Torque Range	0.45...0.8 Nm (4...7 lb-in.)	
LED Indicator	Red	
Repeat Accuracy*	±1%	
Recovery Time	<50 ms	
Selectable Timing Ranges	Three DIP switches, seven ranges (set from 5...100% of range): 1 s, 10 s, 100 s, 10 min, 100 min, 10 h, 100 h	
Selectable Timing Modes	Three DIP switches, eight modes: 1. Power On-Delay 2. Power On One-Shot 3. Power On Repeat Cycle, On Start 4. Signal On-Delay and Signal Off-Delay 5. Signal Off-Delay 6. Signal On-One-Shot 7. Signal Off-One-Shot 8. Signal On and Signal Off Watchdog Monitor	
Adjustable Trimmer Scale Accuracy	±5% of Time Range	
Environmental		
Temperature	Operating	-20 °C...+50 °C (-4 °F...+122 °F)
	Storage	-55 °C...+85 °C (-67...+185 °F)
Altitude	2000 m (6560 ft)	
Construction		
Enclosure	Gray Plastic Housing	
Mounting with Socket Only	8- or 11-Pin Socket with Module Plug	
Sockets	700-HN204 (8-Pin with Plug) 700-HN205 (11-Pin with Plug)	
Certifications	cURus Recognized (File No. E14843, Guide NRNT2/NRNT8), CE Marked	
Standards	UL508, CSA C22.2 No. 14, EN 61810-1, EN 60255-23	

* Performance Data - See this publication, Important 3.
 * At constant voltage and temperature.

Timing Charts, Cat. No. 700-HT3 Multi-Function Time Module (t = Time Range 0.05 s...100 h)

Terms:

U is Power Input

R is Relay Output

S Signal, **+A1** Socket, **B1** Timer

t is the resulting Time Delay (Red LED)

1. Power On-Delay

Apply power (U) to timer. Relay contacts (R) change state after time delay (t) is complete. Contacts return to their shelf state when power is removed. Terminal B1 is not used in this mode.



2. Power On One-Shot

Apply power (U) to timer. Relay contacts (R) change state immediately and the time delay (t) begins. When the time delay (t) is complete, contacts return to their shelf state. Contacts return to their shelf state when power is removed. Terminal B1 is not used in this mode.



3. Power On Repeat Cycle, On Start

Apply power (U) to timer. Relay contacts (R) change state immediately and the time delay (t) begins. When the time delay (t) is complete, the contacts return to their shelf state for time delay (t) (time on = time off). This cycle will repeat until the power is removed. Terminal B1 is not used in this mode.

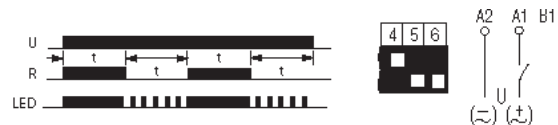

4. Signal On-Delay and Signal Off-Delay

Apply power (U) to timer. When the signal (S) is closed the time delay (t) begins, after the time delay is complete the relay contacts (R) change state. Opening the signal starts the time delay, after the time delay is complete the contacts return to their shelf state. If the signal is closed or opened before the time delay is complete, the time delay is reset. Contacts return to their shelf state when power is removed.



Cat. No. 700-HT3 Timing Modes, Time Description, Timing Charts, and DIP Switch Selections

5. Signal Off-Delay

Apply power (U) to timer. When the signal (S) is closed, the relay contacts (R) change state immediately. When the signal is opened, the time delay (t) begins. If the signal is closed before the time delay is complete, the time delay is reset and the relay remains energized. When the time delay is complete, the contacts return to their shelf state. Contacts return to their shelf state when power is removed.

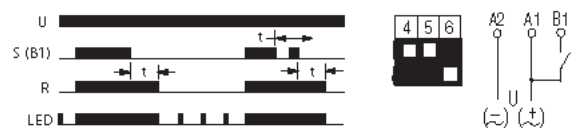

6. Signal On One-Shot

Apply power (U) to timer. When the signal (S) is closed, the relay contacts (R) change state immediately and the time delay (t) begins. After the time delay begins, opening or closing the signal will not reset the time delay. When the time delay is complete, the contacts return to their shelf state. Contacts return to their shelf state when power is removed.



7. Signal Off One-Shot

Apply power (U) to timer. When the signal (S) is closed and then opened, the relay contacts (R) change state immediately and the time delay (t) begins. After the time delay begins, opening or closing the signal will not reset the time delay. When the time delay is complete, the contacts return to their shelf state. Contacts return to their shelf state when power is removed.

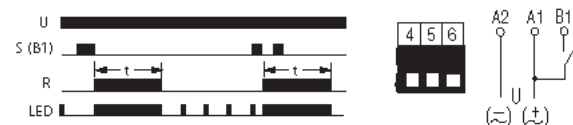

8. Signal On and Signal Off Watchdog Monitor

Apply power (U) to timer. When the signal (S) is closed, the relay contacts (R) energize immediately and the time delay (t) begins. If the signal is opened before the time delay is complete, the relay remains energized and the time delay is reset. When the time delay is complete the contacts return to their shelf state. If the signal is opened after the time delay is complete, the relay contacts energize immediately and the same time delay begins. Continuous cycling of the signal at a rate that is faster than the time delay will cause the relay contacts to remain energized. Contacts return to their shelf state when power is removed.

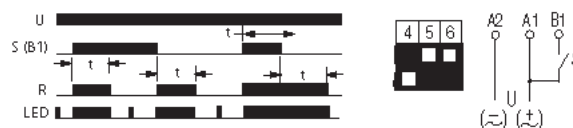

Approximate Dimensions

Approximate Dimensions are shown in millimeters (inches). Approximate Dimensions are not intended to be used for manufacturing purposes.

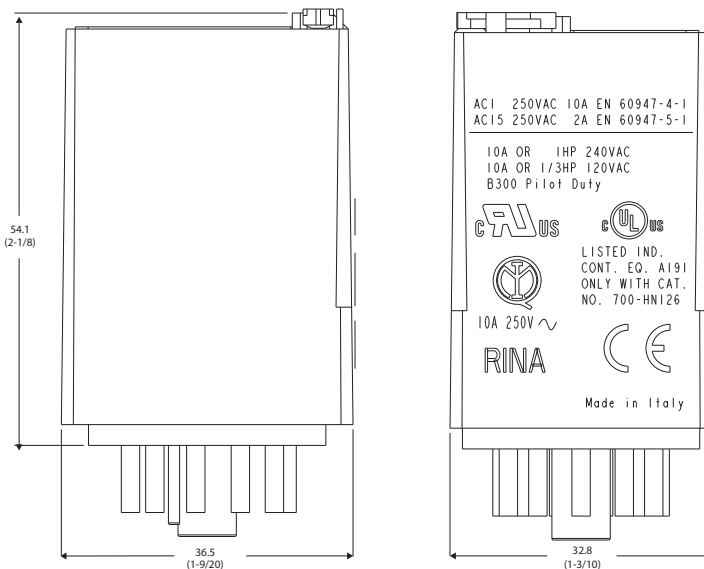

Bulletin 700-HA Relay

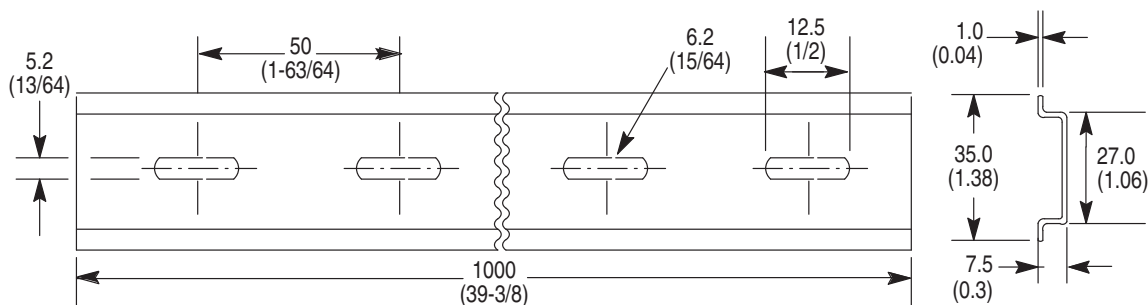

Cat. No. 199-DR1 DIN Mounting Rail Series B
Cat. No. 199-DR4 DIN Mounting Rail Series B Has No Mounting Holes

Cat. No.	A	B	C	D	Approx. Shipping Wt.
199-DR1	35 (1-3/8)	27 (1-1/16)	7.5 (19/64)	1.02 (1/64)	1.85 kg (4.07 lb) (10/pkg)
199-DR4	35 (1-3/8)	27 (1-1/16)	15 (19/32)	2.3 (3/32)	3.68 kg (8 lb) (5/pkg)

Bulletin 700-HA
General Purpose Relays
 Approximate Dimensions

Approximate Dimensions are shown in millimeters (inches). Approximate Dimensions are not intended to be used for manufacturing purposes.

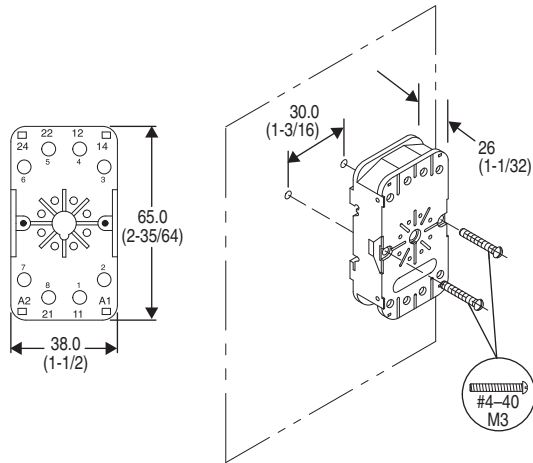

Cat. No. 700-HN100

Panel Mounting

Wire Size: 2 x 2.5 mm²
 Single Wire – Up to #12 AWG
 Double Wire – 2 x 2.5 mm² (#2-14 AWG... #2-20 AWG)
 (Either Solid or Stranded)
 Strip Length: 9 mm (3/8 in.) – Torque: 0.8 N•m (7 lb•in)

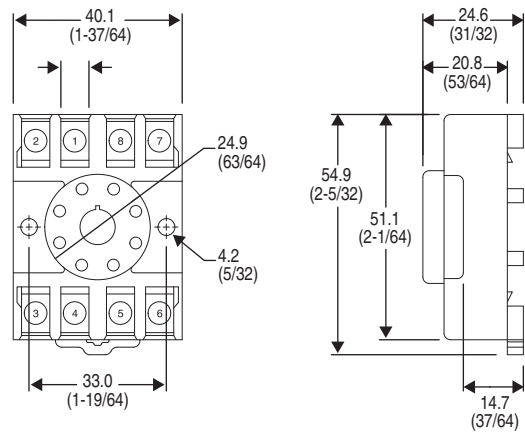

Cat. No. 700-HN125

Wire Size: 2 x 2.5 mm²
 Single Wire – Up to #12 AWG
 Double Wire – 2 x 2.5 mm² (#2-14 AWG... #2-20 AWG)
 (Either Solid or Stranded)
 Strip Length: 9 mm (3/8 in.) – Torque: 0.8 N•m (7 lb•in)

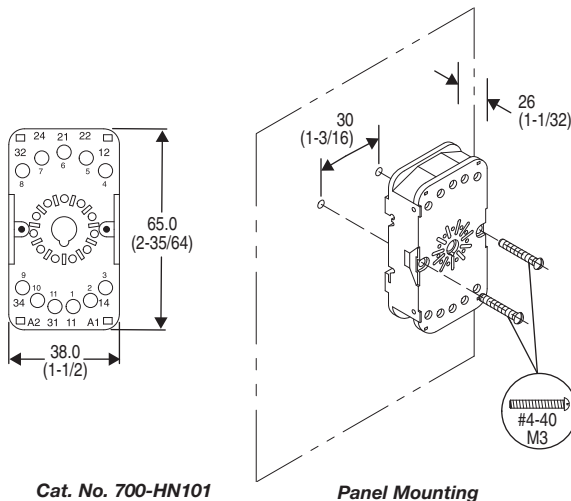

Cat. No. 700-HN101

Panel Mounting

Wire Size: 2 x 2.5 mm²
 Single Wire – Up to #12 AWG
 Double Wire – 2 x 2.5 mm² (#2-14 AWG... #2-20 AWG)
 (Either Solid or Stranded)
 Strip Length: 9 mm (3/8 in.) – Torque: 0.8 N•m (7 lb•in)

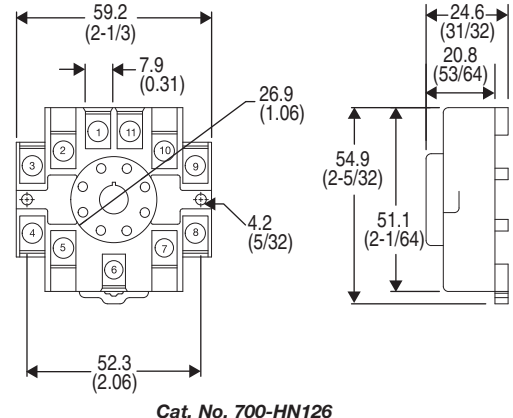

Cat. No. 700-HN126

Wire Size: 2 x 2.5 mm²
 Single Wire – Up to #12 AWG
 Double Wire – 2 x 2.5 mm² (#2-14 AWG... #2-20 AWG)
 (Either Solid or Stranded)
 Strip Length: 9 mm (3/8 in.) – Torque: 0.8 N•m (7 lb•in)

Approximate Dimensions are shown in millimeters (inches). Approximate Dimensions are not intended to be used for manufacturing purposes.

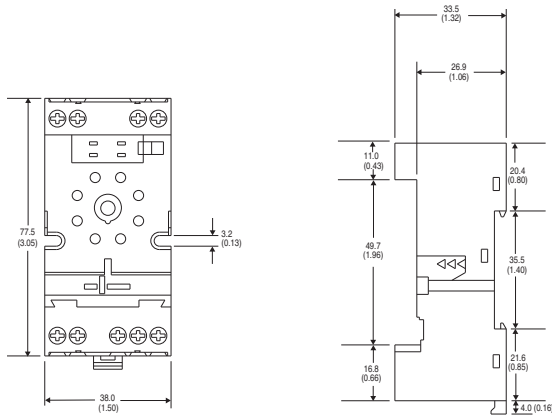

Cat. No. 700-HN204

Wire Size: 2 x 2.5 mm²
 Single Wire – Up to #12 AWG
 Double Wire – 2 x 2.5 mm² (#2–14 AWG... #2–20 AWG)
 (Either Solid or Stranded)
 Strip Length: 9 mm (3/8 in.) – Torque: 0.8 N•m (7 lb•in)

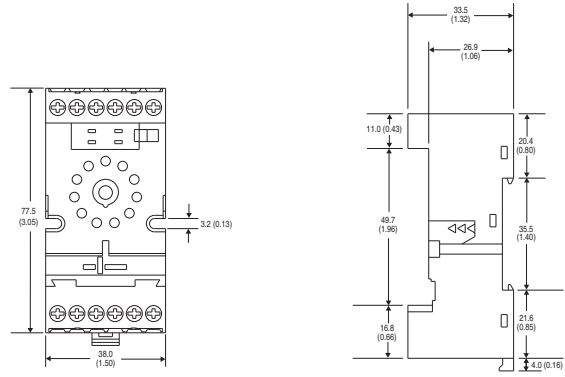

Cat. No. 700-HN205

Wire Size: 2 x 2.5 mm²
 Single Wire – Up to #12 AWG
 Double Wire – 2 x 2.5 mm² (#2–14 AWG ...#2–20 AWG)
 (Either Solid or Stranded)
 Strip Length: 9 mm (3/8 in.) – Torque: 0.8 N•m (7 lb•in)

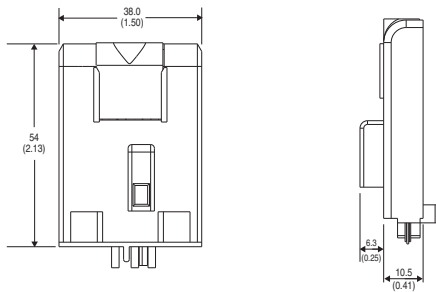

Cat. No. 700-HT3

Wire Size: 2 x 1.5 mm² (#2 – 16 AWG...#1–20 AWG)
 (Either Solid or Stranded)
 Strip Length: 9 mm (3/8 in.) – Torque: 0.8 N•m (7 lb•in)