

# DIN Rail Mounted Timing Relays

## Overview/Product Selection



### Bulletin 700-FE — Economy Timing Relay

- Adjustable function and timing range timing relays
- DIN Rail mounted without cost of socket
- 17.5 mm wide, multi-function or single function
- Available as 1 N.O. or SPDT contact output, 5 A
- Timing ranges from 0.05 s...10.0 hr
- Coil surge protection

### Table of Contents

Product Selection ..... this page  
 Accessories..... this page  
 Specifications..... 9-64  
 Approximate  
 Dimensions..... 9-65

### Standards Compliance and Certifications

See Specification table in this section, page 9-64.

## Product Selection

### Multi-Function

This device offers you the flexibility of selecting one of 4 single timing functions.

Operating Mode	Contact Output	Timing Range	Input Voltage	Cat. No.
ON-delay, OFF-delay, One Shot, Flasher (repeat cycle starting with pulse)	1 N.O.	0.05 s...10 hr (6 settings)‡	24V AC/DC * 110...240V AC 50/60 Hz	<b>700-FEM1TU22</b>
ON-delay, OFF-delay, One Shot, Flasher (repeat cycle starting with pulse)	SPDT (1 C/O)	0.05 s...10 hr (6 settings)‡	24V...48V AC/DC 24...240V AC 50/60 Hz	<b>700-FEM3TU23</b>

### Single-Function

This device offers you one specific timing function.

Operating Mode	Contact Output	Timing Range‡	Input Voltage	Cat. No.
ON-delay	1 N.O.	0.05 s...10 hr (6 settings)	24V AC/DC * 110...240V AC 50/60 Hz	<b>700-FEA1TU22</b>
	SPDT (1 C/O)	0.05 s...10 hr (6 settings)	24V...48V AC/DC 24...240V AC 50/60 Hz	<b>700-FEA3TU23</b>
OFF-delay	1 N.O.	0.05 s...10 hr (6 settings)	24V AC/DC * 110...240V AC 50/60 Hz	<b>700-FEB1TU22</b>
	SPDT (1 C/O)	0.05 s...10 hr (6 settings)	24V...48V AC/DC 24...240V AC 50/60 Hz	<b>700-FEB3TU23</b>
One Shot	1 N.O.	0.05 s...10 hr (6 settings)	24V AC/DC * 110...240V AC 50/60 Hz	<b>700-FED1TU22</b>
	SPDT (1 C/O)	0.05 s...10 hr (6 settings)	24V...48V AC/DC 24...240V AC 50/60 Hz	<b>700-FED3TU23</b>
Fleeting OFF-delay	SPDT (1 C/O)	0.05 s...10 hr (6 settings)	24V...48V AC/DC 24...240V AC 50/60 Hz	<b>700-FEE3TU23</b>
Flasher (repeat cycle starting with pulse)	1 N.O.	0.05 s...10 hr (6 settings)	24V AC/DC * 110...240V AC 50/60 Hz	<b>700-FEF1TU22</b>
	SPDT (1 C/O)	0.05 s...10 hr (6 settings)	24V...48V AC/DC 24...240V AC 50/60 Hz	<b>700-FEF3TU23</b>
Pulse Converter	SPDT (1 C/O)	0.05 s...10 hr (6 settings)	24V...48V AC/DC 24...240V AC 50/60 Hz	<b>700-FEL3TU23</b>

\* Voltage is either 24V AC 50/60 Hz or 24V DC.

‡ Time ranges: 0.05 s...1 s, 0.5...10 s, 0.05...1 min, 0.5...10 min, 0.05...1 hr, 0.5...10 hr.

### Special Functions

Operating Mode	Contact Output	Timing Range*	Input Voltage	Cat. No.
Star-Delta	2 N.O. with 1 Common	0.15 s...10 min (4 settings)	24V...48V AC/DC 24...240V AC 50/60 Hz	<b>700-FEY2QU23</b>

\* Time ranges: 0.15...3 s, 0.5...10 s, 3 s...1 min, 30 s...10 min.

### Accessories

	Description	Pkg. Quantity	Cat. No.
	<b>Panel Mounting Adapter</b> For surface mounting according to drilling plan EN 50 002	5	<b>199-FSA</b>
	<b>Label Sheet</b> 105 self-adhesive paper labels each, 6 x 17 mm	10	<b>100-FMS</b>



**700-FE Function and Connection Diagrams**

**(A) On-Delay**

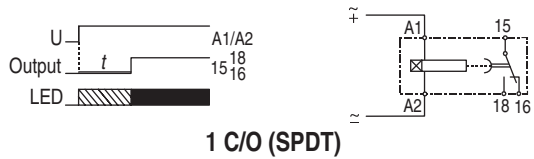
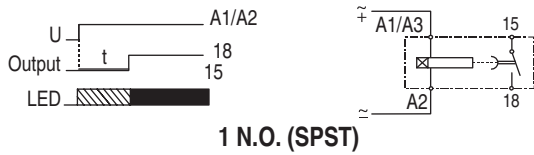

**(D) One Shot**

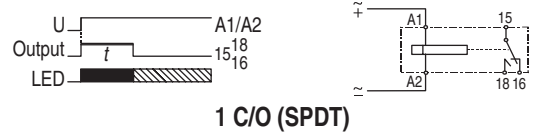
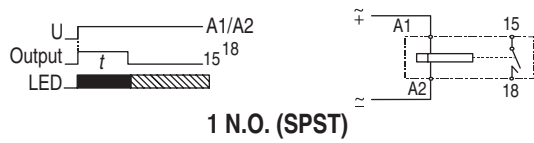

**(E) Fleeting Off-Delay**

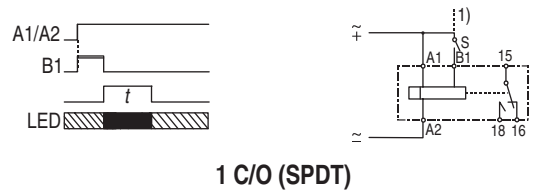

**(Y) Star-Delta Timing Relay**



**Bi-Color LED: 1 C/O (SPDT) or 1 N.O. Contact Timers**

LED U = green: Supply voltage available.  
 LED Relay = red: Output is energized.

**(B) Off-Delay**

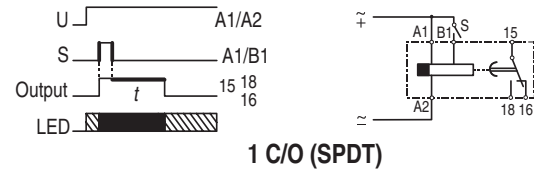
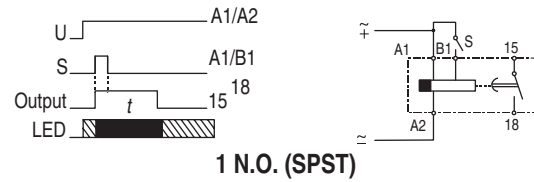

**(F) Flasher (Repeat Cycle Starting with Pulse)**

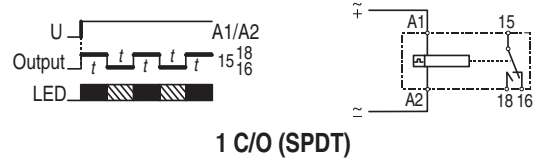
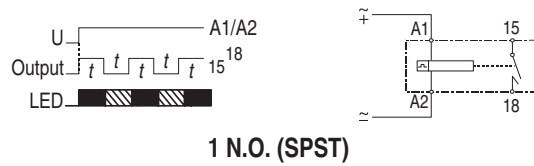

**(L) Pulse Converter**

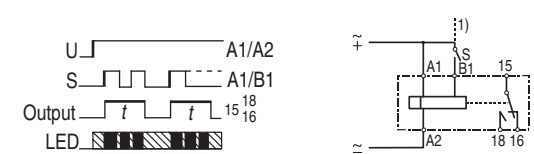



**Single Color LED: 2 N.O. with Common**

ON = green  
 OFF = red

Bulletin 700-FE  
**DIN Rail Mounted Timing Relays**  
 Specifications

**Specifications\***

Time Characteristics (according to VDE 0435, part 2021)

			<b>1 N.O.</b>		<b>SPDT</b>
Setting Accuracy		±5% of full scale			
Repeatability		±1% of setting (typical)			
Tolerance		By voltage: ±0.01%/ΔU By temperature: ±0.25%/°C		By voltage: ±0.001%/ΔU By temperature: ±0.025%/°C	
<b>Supply</b>					
Supply Voltage		24V AC/DC* and 110...240V AC, 50/60 Hz		24...48V DC and 24...240V AC, 50/60 Hz	
Voltage Tolerance	AC	-15%/+10%			
	DC	-15%/+20%			
Power Consumption		0.5 W at 24V DC, 5 VA at 240V AC			
Time Energized		100%			
Reset Time		100 ms			
Cable Length (Supply Voltage Control)		Max. 250 m (750 feet)			
<b>Pulse Control (B1)</b>					
Impulse Duration		≥ 250 ms		≥ 50 ms (AC), ≥ 30 ms (DC)	
Input Voltage		supply voltage range			
Input Current		1 mA			
Cable Length		Max. 250 m without parallel load between B1 and A2 Max. 50 m with load (< 3 kΩ) between B1 and A2			
<b>Outputs</b>					
Contact Type		1 N.O. contact		1 Form C – SPDT contact	
Dielectric Withstand Voltage	Contact-to-coil	4000 V			
	Power	1250 VA			
Switching Capacity	According to IEC 947-5-1	AC-1	5 A /250V AC (resistive load)		
		AC-14	1 A/250V AC (inductive load)		
		DC-13	1 A/24V DC (inductive load)		
According to UL 508		NEMA D300 - 1 A/300V AC			
Short-Circuit Resistance		6 A gL (Fast Blow Fuse)			
Life	Mechanical	20 million operations			
	Electrical	0.4 million at 1 A/250V AC, resistive 0.4 million at 0.5 A/250V AC, cos φ = 0.4 0.4 million at 1 A/24V DC, resistive			
State Indicator		1 Bi-Color LED (Supply; Relay)			
Certifications		cULus Listed (File No. E14840, Guide NKCR/NKCR7), CE Marked			
Standards		EN/IEC 60947-1, EN/IEC 60947-5-1, UL 508, CSA 22.2 No. 14			

\* Performance Data - See this catalog, Important- 3

\* Voltage is either 24V DC or AC 50/60 Hz.



# DIN Rail Mounted Timing Relays

## Specifications/ Approximate Dimensions

### General Specifications

	1 N.O.	SPDT
Insulation Characteristics	2 kV AC/50 Hz test voltage according to VDE 0435 and 4 kV 1.2/50 μs surge voltage according to IEC 60947-1 between all inputs and outputs	
EMC/Interference Immunity	The following requirements are fulfilled: Surge capacity of the supply voltage according to IEC 61000-4-5: Level 3 Burst according to IEC 61000-4-4: Level 3 ESD discharge according to IEC 61000-4-2: Level 3	
EMC/Emission	electromagnetic fields according to EN 55 022: Class B	
Safe Isolation	according to VDE 0106 T 101	
Climatic Withstand	56 cycles (24 hr) at 25...40 °C and 95% relative humidity according to IEC 60068-2-30	
Vibration Resistance	4 g in three axes at 10...500 Hz, test FC according to IEC 60068-2-6	
Shock Resistance	50 g according to IEC 68-2-27	
Protection Class IEC 60947-1	Enclosure:IP 40 Terminal:IP 20	
Weight	60 g	60 g
Certifications	cULus, CE Certified	cULus, Germanischer Lloyd, CE Certified
Ambient Temperature	Open:-25...+60 °C Enclosed:-25...+45 °C Storage:-40...+85 °C	
Connections	Screw terminal M3 for Pozidriv No.1, Phillips and slotted screws No.2. suitable for power screw-driver. Rated tightening torque 8.8 lb.-in. (max. 1.0 Nm) For terminal cross-sections of 1 x 0.5 mm <sup>2</sup> ...2 x 1.5 mm <sup>2</sup> (solid) or 2 x 1.5 mm <sup>2</sup> (stranded with sleeve), #20...14 AWG. Finger protection according to EN 50274	
Mounting	For surface mounting in any position; snap-on mounting on 35 mm DIN Rail or by adapter and two screws (M4 type)	
Disposal	Synthetic materials without dioxin according to EC/EFTA-Notification No. 93/0141/D electrical contacts are AgCdO	

\* Voltage is either 24V DC or AC 50/60 Hz.

### Approximate Dimensions

Approximate dimensions are shown in millimeters (inches). Dimensions are not intended to be used for manufacturing purposes.

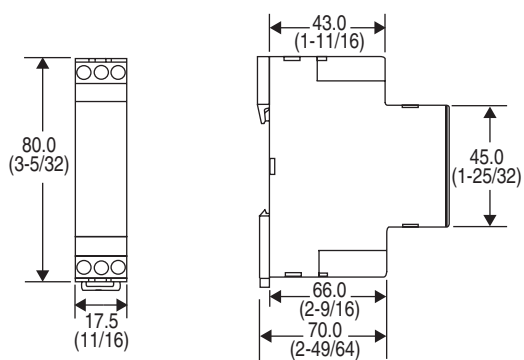

Cat. No. 700-FE...

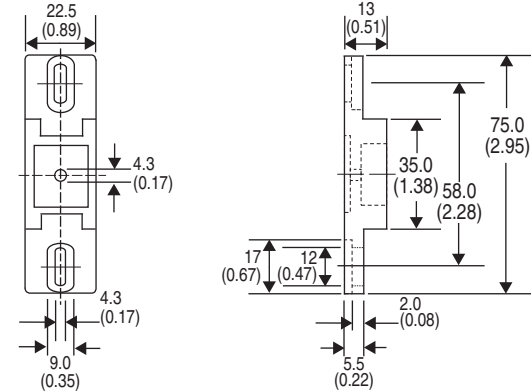

Cat. No. 199-FSA...