



Description

These 30 mm metal-body safety limit switches conform to EN 50041 standards and are available in snap acting or slow break/make with 2-, 3- or 4-contact configurations.

These switches feature a rotating head that can be adjusted in 90° increments before installation to allow for ease of mounting.

Allen-Bradley Guardmaster can be used in guard door applications as well as on moving machine beds, crane arms, lifts, elevators, etc.

Operation of these limit switches is achieved by the sliding action of a guard, or other moving object, deflecting the plunger or lever. For safety applications, it is important that upon actuation, the guard or moving object should not pass completely beyond the switch to allow the plunger or lever to return to its original position—the plunger or lever must remain engaged by the guard or object.

Features

- Large selection of actuator heads
- Positive operation, forced disconnection of contacts
- Snap-acting, slow make before break or slow break before make contact blocks
- Contacts 1 N.C. + 1 N.O., 2 N.C. + 2 N.O., 3 N.C. + 1 N.O., or 4 N.C.
- Conforms to EN 50041, EN 1088, EN 60947-5-1, EN 292 and EN 60204-1

Operating Examples

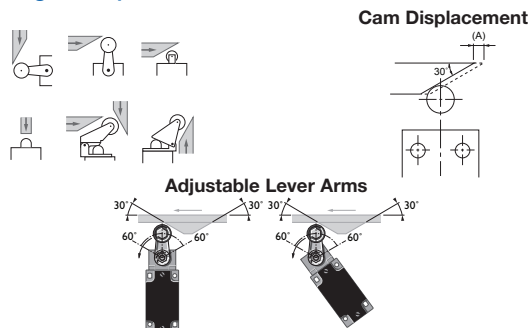

For optimum cam operation, the actuating arm should be adjusted with a 30° offset profile.

Note: Plunger-type switches operate from a flat profile.

Specifications

Safety Ratings	
Standards	EN 954-1, ISO 13849-1, IEC/EN 60204-1, NFPA 79, EN 1088, ISO 14119, IEC/EN 60947-5-1, ANSI B11.19, AS 4024.1
Safety Classification	Cat. 1 Device per EN954-1 Dual-channel limit switch suitable for Cat. 3 or 4 systems and used with a safety monitoring device
Functional Safety Data *	B10d: > 2 x 10 ⁶ operations at min. load PFHD: > 3 x 10 ⁻⁷ MTTFd: > 385 years Dual channel limit switch may be suitable for performance levels Ple or Pld (according to ISO 13849-1:2006) and for use in SIL2 or SIL3 systems (according to IEC 62061) depending on application characteristics
Certifications	CE Marked for all applicable directives, cULus, and TÜV

Outputs	
Safety Contacts *	1 N.C. snap acting, 2 N.C., 3 N.C. or 4 N.C. slow acting
Auxiliary Contacts	1 N.O., 2 N.O., or zero
Thermal Current _{I_{th}}	10 A
Rated Insulation Voltage	600V AC
Switching Current @ Voltage, Min.	25 mA @ 5V DC

Utilization Category					
A600/AC-15	(Ue)	600V	500V	240V	120V
	(Ie)	1.2 A	1.4 A	3.0 A	6.0 A
N600/DC-13	(Ue)	600V	500V	250V	125V
	(Ie)	0.4 A	0.55 A	1.1 A	2.2 A

Operating Characteristics	
Actuation Speed, Max.	250 mm/s
Actuation Speed, Min.	100 mm/min
Actuation Frequency, Max.	6000 operation per hour
Mechanical Life	1 x 10 ⁷

Environmental	
Enclosure Type Rating	IP66
Operating Temperature [C (F)]	-25...80° (-18...+176°)
Pollution Degree	3







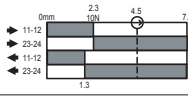
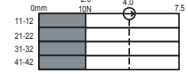
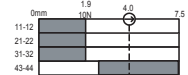
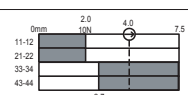

Physical Characteristics	
Housing Material	Die-cast alloy
Actuator Material	Various polymers and metals
Mounting	2 x M5, Any position
Vibration	IEC 68-2-6 (10...55 Hz, 0.35 amplitude)
Shock	IEC 68-2-7 (30 Gn 3 pulses per axis)
Conduit Entry	M20 or 1/2 inch NPT
Color	Red

- * Usable for ISO 13849-1:2006 and IEC 62061. Data other than B10d is based on:
 - Usage rate of 1op/10 mins., 24 hrs/day, 360 days/year, representing 51840 operations per year
 - Mission time/Proof test interval of 38 years
- * The safety contacts are described as normally closed (N.C.) i.e., with the guard closed, actuator in place (where relevant) and the machine able to be started.

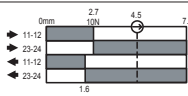
3-Limit Switches

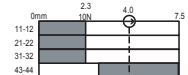
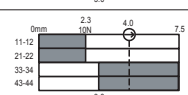
Safety Switches
IEC Style Switches
 30 mm Metal Body

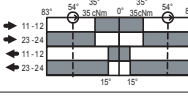
Product Selection

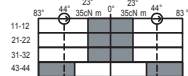
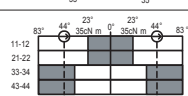
Description	Contact			Typical Force/Torque to Operate	Contact Opening Characteristics □ Open ■ Closed ⊕ Positive Opening Point	Cat. No.		
	Safety	Auxiliary	Type			1/2 inch NPT Conduit	M20 Conduit	Connector *
	1 N.C.	1 N.O.	Snap Acting	13 N		440P-MRPS11E	440P-MRPS11B	440P-MRPS11N5
	4 N.C.	—	—	11 N		440P-MRPB04E	440P-MRPB04B	440P-MRPB04M9
	3 N.C.	1 N.O.	BBM	11 N		440P-MRPB13E	440P-MRPB13B	440P-MRPB13M9
	2 N.C.	2 N.O.	BBM	11 N		440P-MRPB22E	440P-MRPB22B	440P-MRPB22M9
	1 N.C.	1 N.O.	Snap Acting	13 N		440P-MDPS11E	440P-MDPS11B	440P-MDPS11N5
	4 N.C.	—	—	11 N		440P-MDPB04E	440P-MDPB04B	440P-MDPB04M9
	3 N.C.	1 N.O.	BBM	11 N		440P-MDPB13E	440P-MDPB13B	440P-MDPB13M9
	2 N.C.	2 N.O.	BBM	11 N		440P-MDPB22E	440P-MDPB22B	440P-MDPB22M9
	1 N.C.	1 N.O.	Snap Acting	0.34 N•m		440P-MSLS11E	440P-MSLS11B	440P-MSLS11N5
	4 N.C.	—	—	0.20 N•m		440P-MSLB04E	440P-MSLB04B	440P-MSLB04M9
	3 N.C.	1 N.O.	BBM	0.34 N•m		440P-MSLB13E	440P-MSLB13B	440P-MSLB13M9
	2 N.C.	2 N.O.	BBM	0.34 N•m		440P-MSLB22E	440P-MSLB22B	440P-MSLB22M9
Recommended standard cordset, 2 m, 5-pin mini connector.								889N-F5AE-6F
Recommended standard cordset, 2 m, 12-pin 9-wire.								889M-FX9AE-2

* N5 = 5-pin mini connector.
 M9 = 12-pin M23 connector (use 9 wire).

3-Limit Switches

Product Selection (continued)

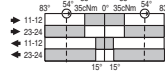
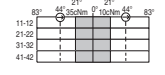
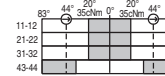
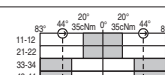
Description	Safety Contacts	Auxiliary Contacts	Contact Type	Typical Force/Torque to Operate	Contact Opening Characteristics □ Open ■ Closed ⊙ Positive Opening Point	Cat. No.		
						1/2 inch NPT Conduit	M20 Conduit	Connector *
	1 N.C.	1 N.O.	Snap Acting	0.34 N•m		440P-MMHS11E	440P-MMHS11B	440P-MMHS11N5
	4 N.C.	—	—	0.20 N•m		440P-MMHB04E	440P-MMHB04B	440P-MMHB04M9
	3 N.C.	1 N.O.	BBM	0.34 N•m		440P-MMHB13E	440P-MMHB13B	440P-MMHB13M9
	Metal Short Lever, Metal Roller	2 N.C.	2 N.O.	BBM	0.34 N•m		440P-MMHB22E	440P-MMHB22B
Recommended standard cordset, 2 m, 5-pin mini connector.								889N-F5AE-6F
Recommended standard cordset, 2 m, 12-pin 9-wire.								889M-FX9AE-2

* N5 = 5-pin mini connector.
M9 = 12-pin M23 connector (use 9 wire).

Typical Wiring Diagrams

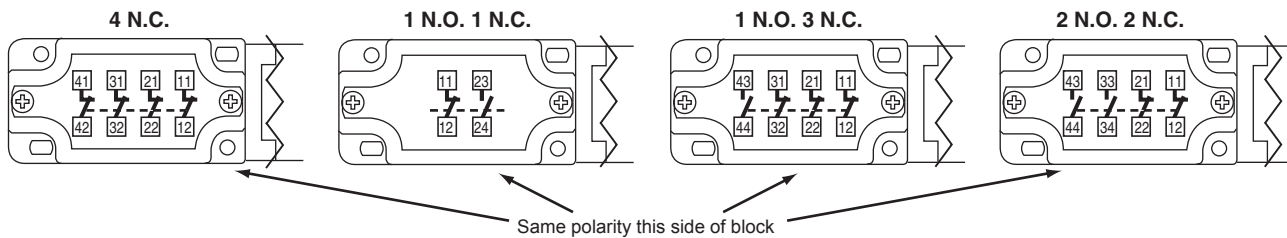

N5 Connector 2 Circuit 5-Pin Mini Connector

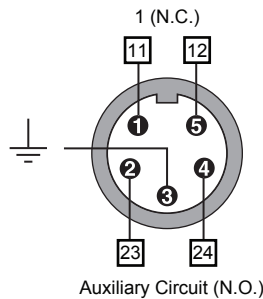

M9 12-Pin M23 Connector

Connector Pinout	4 N.C.		3 N.C. 1 N.O.		3 N.C.	
	Terminal	Contact	Terminal	Contact	Terminal	Contact
1	11		11		11	
3	12	N.C.	12	N.C.	12	N.C.
4	21	N.C.	21	N.C.	21	N.C.
6	22	N.C.	22	N.C.	22	N.C.
7	31	N.C.	31	N.C.	33	N.O.
8	32	N.C.	32	N.C.	34	N.O.
9	41	N.C.	43	N.O.	43	N.O.
10	42	N.C.	44	N.O.	44	N.O.
12				Ground		

Safety Switches
IEC Style Switches
 30 mm Metal Body

Approximate Dimensions [mm (in.)]

Dimensions are not intended to be used for installation purposes.

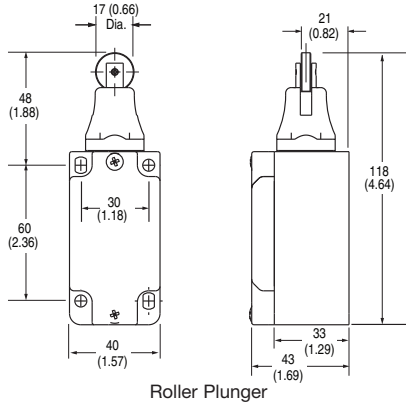

Roller Plunger

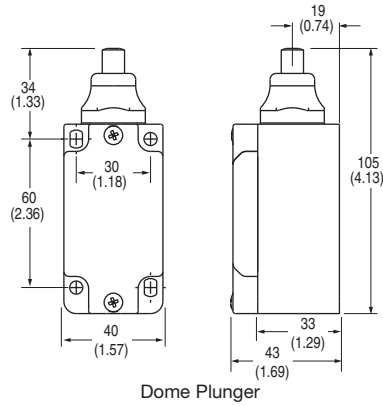

Dome Plunger

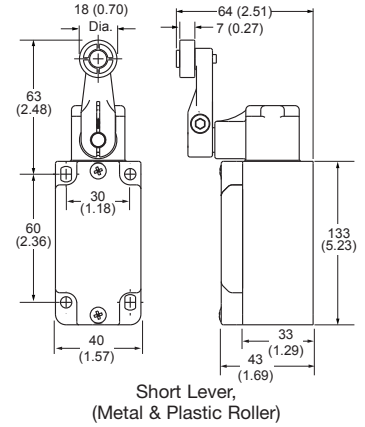

Short Lever,
 (Metal & Plastic Roller)

3-Limit
 Switches