

Installation Instructions

Series 7000 PHOTOSWITCH® Photoelectric Sensors

	Sensing Mode		Standard Diffuse	Wide Angle Diffuse	Fixed Focus Diffuse		ClearSight™		Retro-reflective	Polarized Retro-reflective	Visible Red Plastic Fiber Optic	Infrared Transmitted Beam			Visible Red Transmitted Beam				
					Visible Red	Visible Green	Linear Polarized Sensor	Circular Polarized Sensor				Source	Receiver (8° Field of View)	Receiver (2° Field of View)	Source	Receiver (8° Field of View)	Receiver (2° Field of View)		
1	NPN	3m Cable	42SMP-7000	42SMP-7010	42SMP-7020	42SMP-7320	42SMU-7250	42SMU-7260	42SMU-7000	42SMU-7200	42SMF-7100	42SML-7100	42SMR-7100	42SMR-7120	42SML-7110	42SMR-7110	42SMR-7130		
		DC Micro QD	42SMP-7000-QD	42SMP-7010-QD	42SMP-7020-QD	42SMP-7320-QD	42SMU-7250-QD	42SMU-7260-QD	42SMU-7000-QD	42SMU-7200-QD	42SMF-7100-QD	42SML-7100-QD	42SMR-7100-QD	42SMR-7120-QD	42SML-7110-QD	42SMR-7110-QD	42SMR-7130-QD		
	PNP	3m Cable	42SMP-7001	42SMP-7011	42SMP-7021	42SMP-7321	42SMU-7251	42SMU-7261	42SMU-7001	42SMU-7201	42SMF-7101	42SML-7100	42SMR-7101	42SMR-7121	42SML-7110	42SMR-7111	42SMR-7131		
		DC Micro QD	42SMP-7001-QD	42SMP-7011-QD	42SMP-7021-QD	42SMP-7321-QD	42SMU-7251-QD	42SMU-7261-QD	42SMU-7001-QD	42SMU-7201-QD	42SMF-7101-QD	42SML-7100-QD	42SMR-7101-QD	42SMR-7121-QD	42SML-7110-QD	42SMR-7111-QD	42SMR-7131-QD		
2	Sensing Distance		—								Depends on Fiber Optic Cable Selected	9.2m (30ft)			7.6m (25ft)				
	White Paper		305mm (12in)	280mm (11in)	15.2mm (0.6in)		—												
	Flat Black		—		76mm (3in)		—												
	White Thread		—		30mm (1.2in)		—												
	76mm (3in) Reflector		—				1.5m (4.9ft)		3.75m (12ft)	2.0m (6.5ft)	—								
	32mm (1.25in) Reflector		—				0.76m (2.5ft)		2.12m (7ft)	1.02m (3.3ft)	—								
	16mm (0.625in) Reflector		—				0.76m (2.5ft)		—										
3	Output		Complementary N.O./N.C.										—	Complementary N.O./N.C.		—	Complementary N.O./N.C.		
4	Supply Voltage		11-28V DC																
5	Supply Current		46mA								45mA	25mA		35mA		25mA			
6	Load Current		100mA max								—	100mA max		—		100mA max			
7	Leakage Current		10µA max								—	10µA max		—		10µA max			
8	Power Consumption		1.2 Watts																
9	Response Time		500µs			1ms			500µs		1ms		—	1ms ON/1.5ms OFF		—		1ms ON/1.5ms OFF	
10	Transmitting LED		Infrared 880nm		Visible Red 660nm	Visible Green 570nm	Visible Red 660nm				Infrared 880nm	—		Visible Red 660nm		—			
11	Indicators		Red: Output																
12	Field of View		7°	43°	—			3°			Depends on Fiber Optic Cable Selected	3°	8°	2°	3°	8°	2°		
13	Housing/Lens Material		Valox®/Acrylic																
14	Sensitivity Adjustment		4-Turn Clutch Protected Potentiometer																
15	Protections		Reverse Polarity Protection																
16	Operating Temperature		-40°C to +65°C (-40°F to +150°F)																
17	Relative Humidity		5% - 95%																
18	Operating Environment		NEMA 3, 4X, 6P, 12, 13; IP67 (IEC 529)																
19	Approvals		UL, CSA, and CE marked for all applicable directives																
20	Vibration		10-55Hz, 1mm amplitude, Meets or exceeds IEC 60947-5-2																
21	Shock		30G, Meets or exceeds IEC 60947-5-2																

English	Français	Italiano	Deutsch	Español	Português
Operating Distance Selection The maximum operating distance is based on installing the sensor in a relatively clean environment. Normal industrial environments actually range from moderately dusty to extremely dirty. Greater operating margin may be required which can be obtained by reducing the operating distance of the control.	Choix de la Distance de Fonctionnement La distance maximale de fonctionnement dépend de la propreté relative de l'environnement d'installation de la cellule. A vrai dire, les environnements industriels normaux vont de modérément poussiéreux à extrêmement sales. Une marge d'opération plus grande peut être nécessaire et s'obtient en réduisant la distance opérationnelle du contrôle.	Selezione Distanza Operativa La massima distanza di funzionamento si basa sull'installazione del sensore in un ambiente relativamente pulito. Gli ambienti industriali normali vanno in verità da moderatamente polverosi a estremamente sporchi. Potrebbe essere necessario un margine di funzionamento superiore che si può ottenere riducendo la distanza operativa del controllo.	Wahl der Reichweite Die maximale Reichweite basiert auf einer Installation des sensors in einer relativ sauberen Umgebung. Normale industrielle Umgebungen sind zumeist jedoch relativ staubig bis äußerst verschmutzt. In diesem Fall ist eine größere Betriebsspanne erforderlich, die durch einen geringeren Abstand erzielt werden kann.	Selección de Distancia de Operación La distancia máxima de operación se basa en la instalación del sensor en un ambiente relativamente limpio. Los ambientes industriales normales fluctúan entre moderadamente polvorosos a extremadamente sucios. Es posible que se requiera un margen de operación mayor, el cual puede obtenerse reduciendo la distancia operativa del control.	Seleção da Distância de Operação A distância máxima de operação é baseada na instalação do sensor em ambiente relativamente limpo. Os ambientes industriais normais efetivamente apresentam condições entre moderadamente poeirentos e extremamente sujos. Poderá ser exigida uma maior margem de operação, podendo ser realizada pela redução da distância de operação do controle.
Indicators Red: Output	Indicateurs Rouge: sortie	Indicatori Rosso: Uscita	Leuchanzeigen Rott: Schaltausgang	Indicadores Rojo: Salida	Indicadores Vermelho: Saídaverde
Complementary Normally Open and Normally Closed Outputs	Sorties complémentaires normalement ouvertes et normalement fermées	Uscite Complementari Normalmente Aperte e Normalmente Chiuse	Antivalente Schliesser- und Öffnerausgänge	Salidas Complementarias Normalmente Abiertas y Normalmente Cerradas	Saídas Complementares Normalmente Aberta e Normalmente Fechada
Depends on Glass Fiber Optic cable selected	Dépend de la fibre optique verre choisie	Dipende dalla Fibra Ottica in Vetro scelta	Hängt von der Wahl des Glas-Lichtleiters ab.	Depende del cable de Fibra Óptica seleccionado	Depende do cabo de fibra óptica de vidro escolhido
Potentiometer	Potentiomètre	Potenziometro	Potentiometer	Potenciómetro	Potenciômetro
Reverse Polarity	Inversion de polarité	Inversione di Polarità	Verpolungsschutz	Polaridad Invertida	polaridade invertida
Sensing Mode	Mode de détection	Tipo di Rilevamento	Betriebsart	Modo de Detección	Modo de detecção
UL listed, CSA certified, and CE marked for all applicable directives	Listés UL, Certifiés CSA, et marqués CE en conformité avec toutes les directives applicables	Elencato UL, certificato CSA, e marcato CE per tutte le direttive applicabili	UL- Eintragung, CSA-Zertifikat, und CE-Kennzeichnung nach allen anwendbaren Richtlinien	Certificado CSA, listado UL, y marca CE	Certificado por CSA, listado por UL, e marcado com CE segundo diretrizes aplicáveis
10-55Hz, 1mm amplitude, meets or exceeds IEC 60947-5-2	10-55Hz, amplitude 1mm, conforme ou supérieur à la norme CEI 60947-5-2	10-55Hz, 1mm di ampiezza, soddisfa o supera la IEC 60947-5-2	10-55Hz, 1mm Amplitude, erfüllt oder übertrifft IEC 60947-5-2	10-55Hz, 1mm de amplitud, satisface o supera IEC 60947-5-2	10-55Hz, 1mm de amplitude, atende ou excede a norma IEC 60947-5-2
30G with 1ms pulse duration	30G avec durée d'impulsion de 1ms	30G con durata impulso 1ms	30G bei 1ms Pulsdauer	30G con una duración de pulso de 1 ms	30G com duração de pulso de 1ms
Retroreflective	Réflex	A Riflessione	Reflexions-Lichtschranke	Retroreflectivo	Retro-reflexivo
Polarized Retroreflective	Réflexe polarisé	Retroriflessivo polarizzato	Reflexionslichtschranke, polarisiert	Retrorreflectivo polarizado	Feixe Retro-Refletido, Luz Polarizada
Standard Diffuse	Proximité standard	Taster standard	Lichttaster	Difusa Normal	Feixe Difuso-Refletido Padrão
Fixed Focus Diffuse	Proximité à focale fixe	Taster focalizzato	Lichttaster mit fester Fokussierung	Difusa de Foco Fijo	Feixe Difuso-Refletido, com Foco Fixo
Wide Angle Diffuse	Proximité grand angle	Taster a grand'angolo	Weitwinkel-Lichttaster	Difusa Gran Angular	Feixe Difuso-Refletido, com Grande Abertura
Transmitted Beam	Barrage	Barriera	Einweg-Lichtschranke	Haz Transmitido	Feixe Transmitido
Visible Red	Rouge visible	Fibre ottiche ad emissione Rosso Visibile	Sichtbares Rotlicht	Rojo Visible	luz vermelha visível
Plastic Fiber Optic	Fibre optique en plastique	Fibra ottica in plastica	Kunststofflichtleiter		Fibra Ótica Plástica
Accessories	Accessoires	Accessori	Zubehör	Accesorios	Accessórios
Cable Version	Version de câble	Versione Cavo	Kabelauführung	Versión de Cable	Versão pré-cabeada
Dimensions	Encombrements	Dimensioni	Abmessungen	Dimensiones	Dimensões
Mini QD Version	Version à connecteur mini	Versione con connettore Mini 7/8"	Mini-Ausführung	Versión Conector Mini	Versão mini-desconexão rápida
Operating Distance	Distance de fonctionnement	Distanza di funzionamento	Schaltabstand	Distancia de Operación	Alcance
Operating Margin	Marge de fonctionnement	Margine operativo	Funktionsreserve	Margen Operativo	Margem
Typical Response Curve	Courbe de réponse	Curva di risposta	Diagramm. Relative Empfangs-Lichtstärke / Reich-/Fastweite	Curva de Respuesta Típica	Curva de resposta típica
Wiring Diagrams	Schémas de câblage	Schema Collegamenti	Anschluss-Schema	Diagramas de Cableado	Diagramas de Conexão
1	3m Cable	Câble 3m	3m Cavo	3m Kabel	Cabo 3m
	DC Micro QD	Connecteur micro M12 c.c.	Connettori Micro M12 per CC	Mikro-Steckverbinder (DC)	Cabos micro-desconexão rápida, CC
2	Sensing Distance	Direction de détection	Direzione di Rilevamento	Abstrichtung	Dirección de detección
	White Paper	Papier blanc	Carta Bianca	Weissem Papier	Papel Branco
	Flat Black	Plat Noir	Piano Nero	Mattschwarzes	Plano Negro
	White Thread	Blanc Amorçage	Bianco Filetto	Weißes Gewinde	Blanca Cuerda de rosca
	Reflector	Réflacteur	Riflettore	Reflektor	Reflector
3	Output	Sortie	Uscita	Ausgang	Saída
4	Supply Voltage	Tension d'Alimentation	Tensione di Alimentazione	Versorgungsspannung	Voltaje de Alimentación
5	Supply Current	Intensité d'Alimentation	Corrente di Alimentazione	Versorgungsstrom	Corriente Suministrada
6	Load Current	Courant de Charge	Corrente di Carico	Laststrom	Corriente de Carga
7	Leakage Current	Courant de Fuite	Corrente di Dispersione	Ruhestrom	Corriente de Fuga
8	Power Consumption	Consumation	Consumo Potenza	Leistungsaufnahme	Consumo de Alimentación eléctrica
9	Response Time	Temps de Réponse	Tempo di Risposta	Ansprechzeit	Tiempo de Respuesta
10	Transmitting (LED)	LED de Transmission	LED di Trasmissione	Lichtquelle (LED)	LED de Transmisión
11	Indicators	Indicateurs	Indicatori	LEDLeucht-Kontrollanzeigen	Indicadores
12	Field of View	Champ optique	Campo di Visione	Öffnungswinkel	Campo de Visión
13	Housing/Lens Material	Matériaux du Boîtier/du Couvercle/des Lentilles	Materiale dell'Involucro/per la Copertura/delle Lenti	Gehäusematerial/Werkstoff der Abdeckung/Linsenmaterial	Material del Alojamiento/de la Cubierta/del Lente
14	Sensitivity Adjustment	Réglage de Sensibilité	Regolazione di Sensibilità	Empfindlichkeitseinstellung	Ajuste de Sensibilidad
15	Protections	Protections	Protezioni	Schutzart	Protecciones
16	Operating Temperature	Température de Fonctionnement	Temperatura di Funzionamento	Betriebstemperatur	Temperatura de Operación
17	Relative Humidity	Humidité Relative	Umidità Relativa	Relative Luftfeuchtigkeit	Humedad Relativa
18	Operating Environment	Environnement Opérationnel	Ambiente Operativo	Betriebsumgebung	Ambiente de Operación
19	Approvals	Homologations	Approvazioni	Approbation	Aprobaciones
20	Vibration	Vibration	Vibrazione	Vibration	Vibração
21	Shock	Choc	Urto	Schock	Choque

Typical Response Curves—mm (inches)

Retroreflective

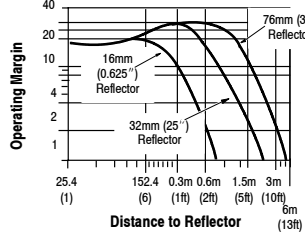

Polarized Retroreflective

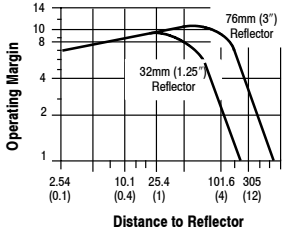

Standard Diffuse

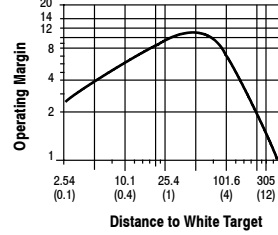

Wide Angle Diffuse

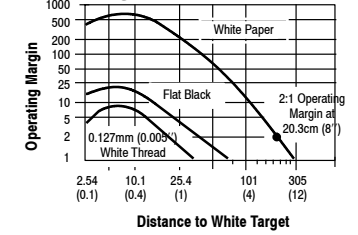

Fixed Focus Visible Red

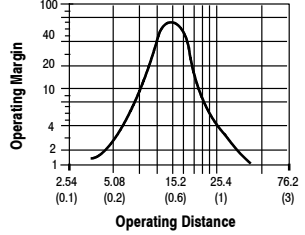

Fixed Focus Visible Green

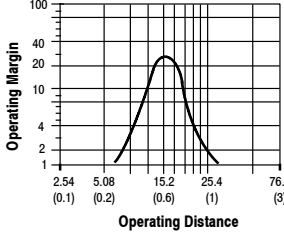

Transmitted Beam

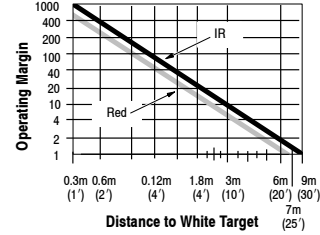

ClearSight

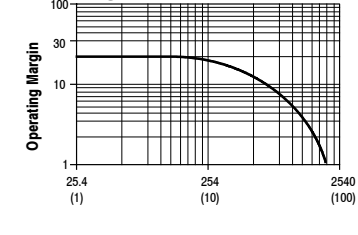

Visible Red Plastic Fiber Optic Transmitted Beam for 0.5mm (0.02in) Dia. and 1mm (0.04in) Dia. Plastic Fibers Coiled

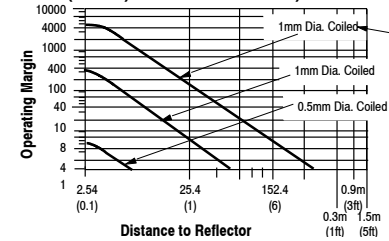

Visible Red Plastic Fiber Optic Transmitted Beam for 0.5mm (0.02in) Dia. and 1mm (0.04in) Dia. Plastic Fibers

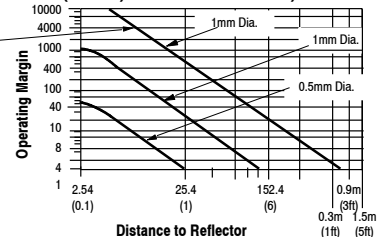

Visible Red Plastic Fiber Optic Reflective Beam for 1mm (0.04in) Dia. Plastic Fibers

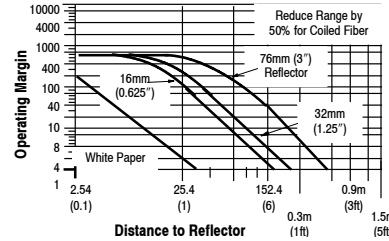

Visible Red Plastic Fiber Optic Reflective Beam for 0.5mm (0.02in) Dia. Plastic Fibers

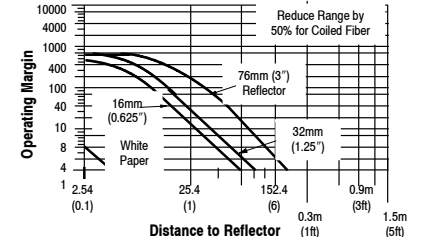

Wiring Diagrams

All Models Except Transmitted Beam Source

NPN Output 7_0

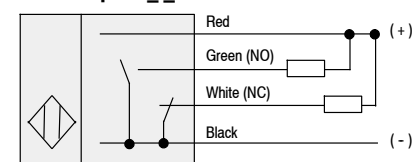

PNP Output 7_1

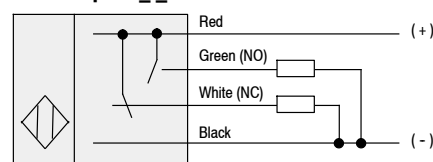

NPN Output 7_0-QD

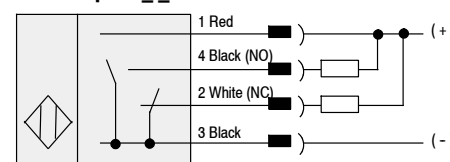

PNP Output 7_1-QD

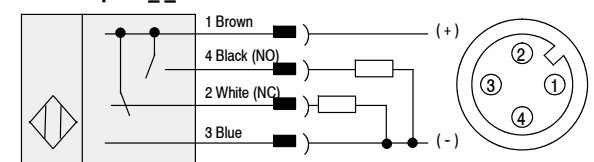

Transmitted Beam 71_0

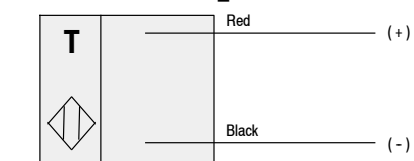

71_0-QD

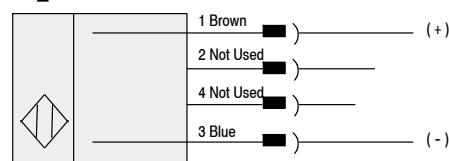

Sensor Dimensions—mm (inches)

All Models Except Visible Red Plastic Fiber Optic—mm (inches)

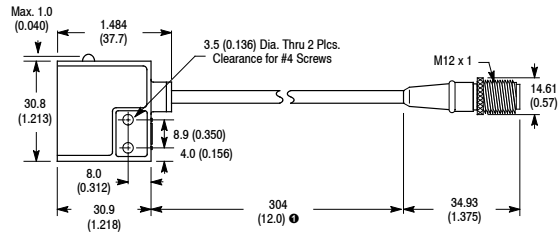

- Quick-disconnect cable length shown. Cable versions length is 10ft (3m).

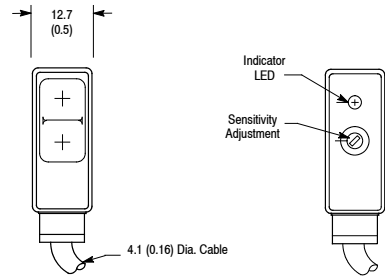

Front View (Lens)

Rear View

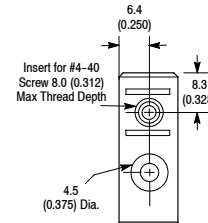

Bottom View

Visible Red Plastic Fiber Optic Models

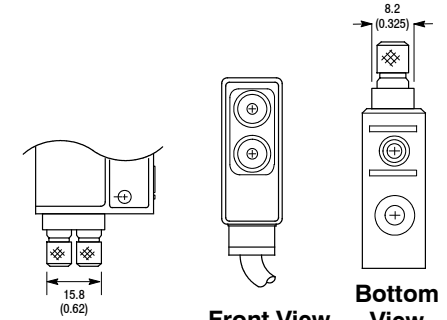

Front View

Bottom View

Accessories

Side Mounting Assembly #60-2151 ①

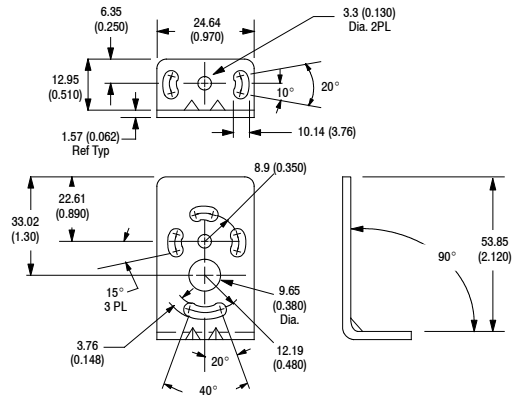

Universal Mounting Assembly #60-2152 ①

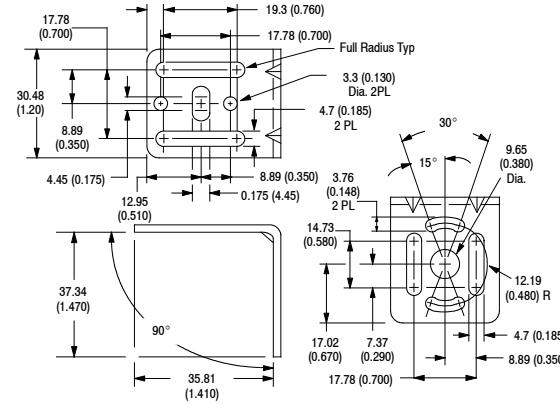

Description	Catalog Number
Field Mount Terminal Chamber, 4-pin DC micro	871A-TS4-DM
Cordset, 2m (6.5ft), 4-pin DC micro	889D-F4AC-2
Reflector—1.25 inch diameter	92-47
Reflector—3 inch diameter	92-39
Fiber Optic Cable, Plastic, Bifurcated	99-94
Fiber Optic Cable, Plastic, Individual	99-90

Swivel/Tilt Bracket #60-2619

