



RightSight DC model with short 18 mm base

Features

- Compact right angle housing
- Flexible 18 mm mounting options
- 1200 psi washdown rating
- Non-adjustable, adjustable and teach versions
- 360° visible LED indicators
- Reverse polarity protection
- Short-circuit protected outputs
- Fast 1 ms response time (DC)
- False pulse protection
- Variety of output types
- Laser models available (see page 1-108)

Specifications

Environmental	
Certifications	UL Listed, CSA Certified and CE Marked for all applicable directives
Operating Environment	NEMA 4X, 6P, IP67 (IEC 529); 1200 psi (8270 kPa) washdown, IP69K
Operating Temperature [C (F)]	-25...+70° (-13...+158°) ≤ 132V AC/DC -25...+55° (-13...+131°) ≥ 132V AC/DC
Vibration	10...55 Hz, 1 mm amplitude, meets or exceeds IEC 60068-2-6
Shock	30 g with 1 ms pulse duration, meets or exceeds IEC 60068-2-27
Relative Humidity	5...95% (noncondensing)
Ambient Light Immunity	Incandescent light 5000 lux
Optical	
Sensing Modes	Retroreflective, polarized retroreflective, diffuse, background suppression, sharp cutoff, fixed focus, fiber optic, transmitted beam
Sensing Range	See Product Selection table on page 1-34
Field of View	See Product Selection table on 1-34
Light Source	Visible red LED (660 nm) or infrared LED (880 nm)
LED Indicators	See User Interface below
Adjustments	Sensitivity potentiometer, teach button, or fixed by cat. no.
Electrical	
Voltage	10.8...30V DC, 21.6...264V AC
Current Consumption	35 mA max (DC), 25 mA max (AC)
Sensor Protection	False pulse, reverse polarity, overload, short circuit
Outputs	
Response Time	1 ms (4 ms for transmitted beam) DC models 8.3 ms (16.6 ms for transmitted beam) AC models
Output Type	PNP or NPN by cat. no., PNP and NPN, N-MOSFET
Output Mode	Complementary light or dark operate, light or dark operate by cat. no.
Output Current	100 mA
Output Leakage Current	0.1 mA max (DC); 0.4 mA max (AC)
Mechanical	
Housing Material	Mindel
Lens Material	Acrylic
Cover Material	Udel
Connection Types	2 m cable, 4-pin DC micro (M12) QD, 4-pin pico (M8) QD
Supplied Accessories	18 mm fastening nuts
Optional Accessories	See mounting brackets, reflectors, and cordsets on page 1-39

User Interface

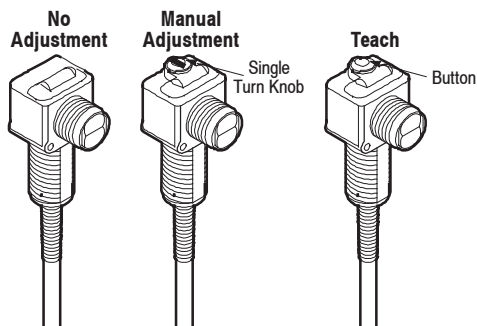

Color	State	Status—Nonteach Version	Status—Teach Version
Yellow	OFF	Output de-energized	Output de-energized
	ON	Output energized	Output energized
	Flashing	SCP active	NA
Orange	OFF	Margin < 2.5	Normal operation
	ON	Margin > 2.5	Teach mode active
	Flashing	Output SCP active (AC models only)	Teach mode active or output SCP active
Green	OFF	Sensor not powered, SCP active, output active	Sensor not powered
	ON	Sensor powered	Sensor powered
	Flashing	NA	Unstable margin condition or output SCP active

Note: For DC models output and margin LEDs alternate flashing when SCP active.

Wiring Diagrams ①②

21.6...264V AC/DC Sensors

AC Wiring for 42EF- C - Models

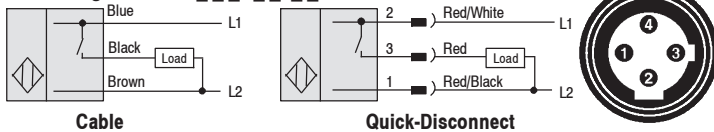

DC Wiring for 42EF- C - Models

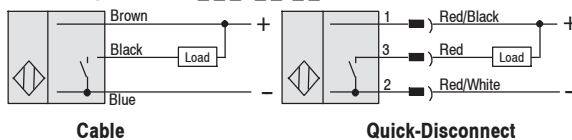

AC Wiring for 42EF- F - Models

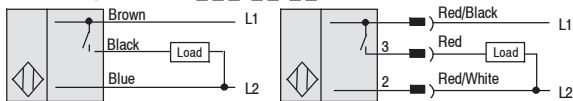

DC Wiring for 42EF- F - Models

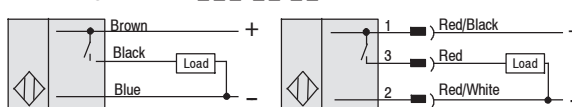

Transmitted Beam Source

21.6...264V AC/DC



10.8...30V DC Sensors

Models with Dual NPN and PNP Outputs

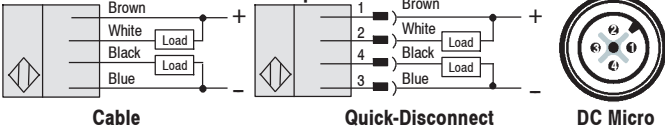

Models with Complementary NPN Outputs

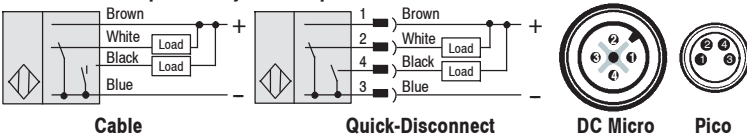

Models with Complementary PNP Outputs

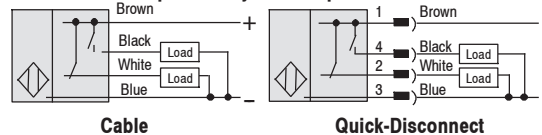

- ① For Rockwell Automation programmable controller compatible interface, refer to publication 42-2.0.
- ② All wire colors on quick-disconnect models refer to Rockwell Automation cordsets.

Approximate Dimensions [mm (in.)]

AC/DC and DeviceNet Models

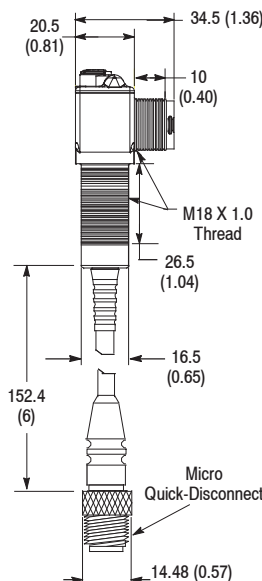

DC Models

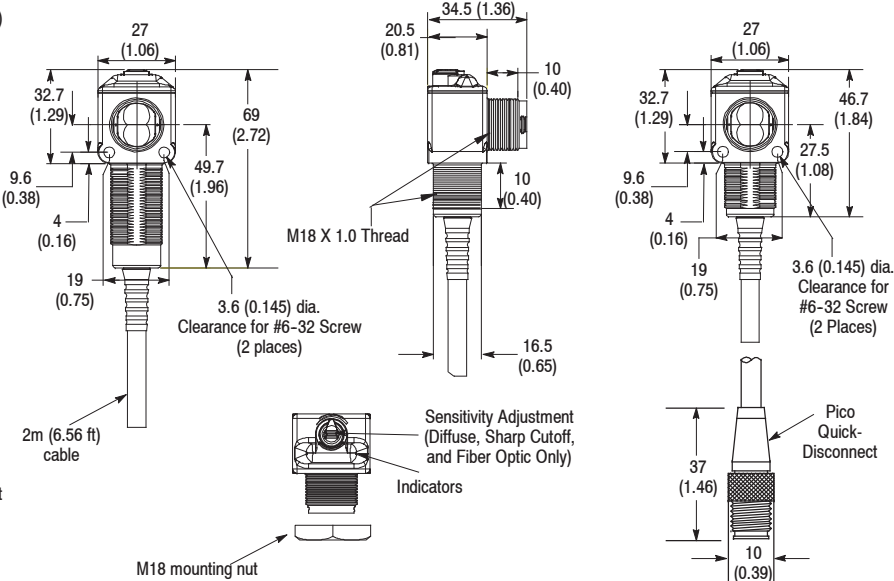

Note: All sensors supplied with one M18 mounting nut (Cat. No. 75012-097-01) except fiber optic models which come with two M18 mounting nuts (Cat. No. 75012-025-01).

Typical Response Curve

Retroreflective

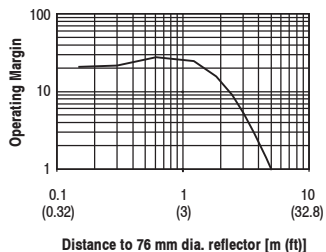

Beam Pattern

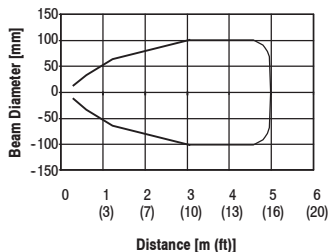

Typical Response Curve

Polarized Retroreflective

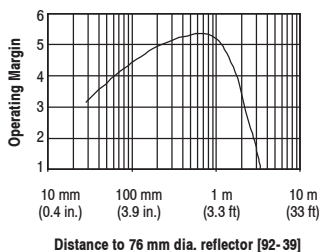

Beam Pattern

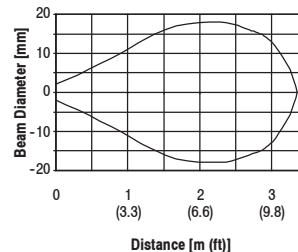

Standard Diffuse—Nonteach

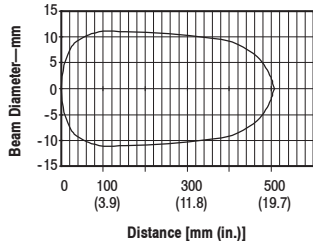
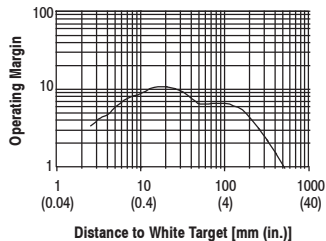

Standard Diffuse—Teach

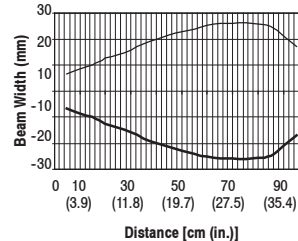
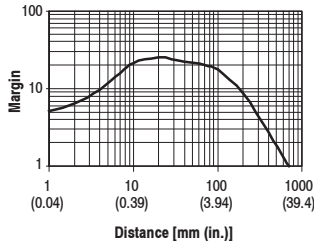

Background Suppression 50 mm

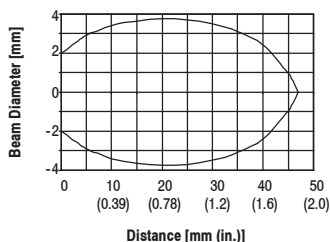
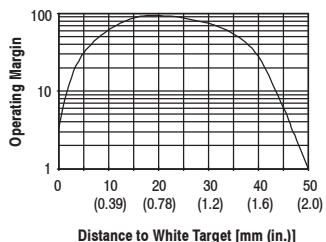

Background Suppression 100 mm

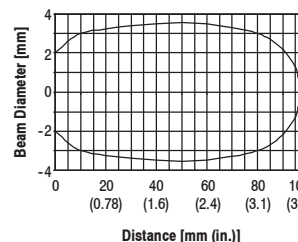
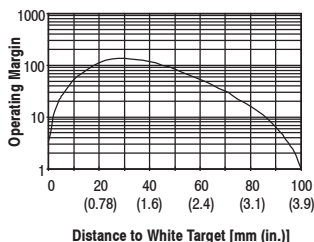

Transmitted Beam

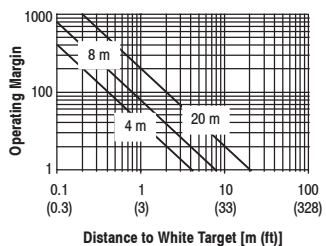

4 m Receiver Models

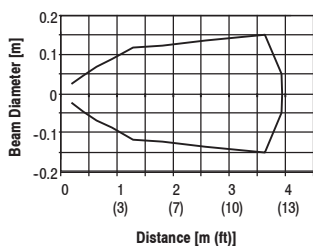

Transmitted Beam 20 m Receiver Models

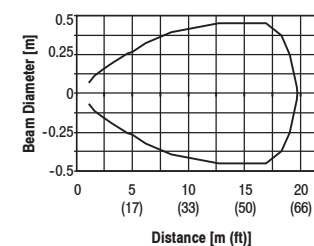

Fixed Focus

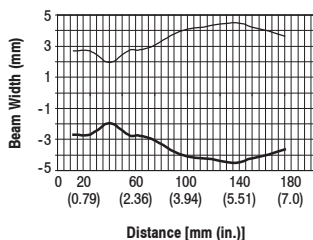
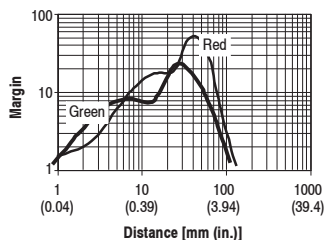

Sharp Cutoff Diffuse

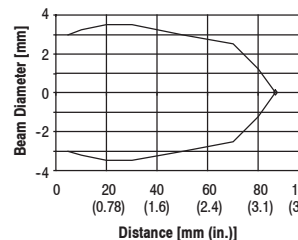

Product Selection

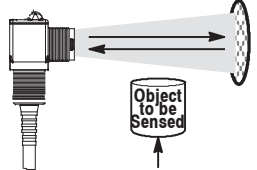
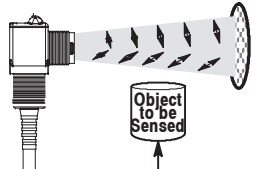
Sensing Mode	Current @ Voltage	Sensing Distance	Adjustment Type	Output Energized	Output Type/ Capacity Response Time	Connection Type	Cat. No.	
 <p>Retroreflective Field of View: 2.5° Emitter LED: Visible red 660 nm</p>	35 mA @ 10.8...30V DC	25 mm...4.5 m (1 in...14.7 ft)	No Adjustment	Dark Operate	NPN and PNP 100 mA 1 ms	2 m 300V cable	42EF-U2KBB-A2	
				Light Operate		4-pin DC micro	42EF-U2KBB-F4	
				Dark Operate	N-MOSFET* 100 mA 8.3 ms	2 m 300V cable	42EF-U2JBB-A2	
				Light Operate		4-pin DC micro	42EF-U2JBB-F4	
	 <p>Polarized Retroreflective Field of View: 1.5° Emitter LED: Visible red 660 nm</p>	35 mA @ 10.8...30V DC	25 mm...3 m (1 in...9.8 ft)	No Adjustment	Dark Operate	NPN and PNP 100 mA 1 ms	2 m 300V cable	42EF-P2KBB-A2
					Light Operate		4-pin DC micro	42EF-P2KBB-F4
					Complementary Light and Dark Operate	NPN 100 mA 1 ms	2 m 300V cable	42EF-P2MNB-A2
							4-pin DC micro	42EF-P2MNB-F4
Dark Operate		PNP 100 mA 1 ms	4-pin pico QD	42EF-P2MNB-Y4				
			2 m 300V cable	42EF-P2MPB-A2				
			4-pin DC micro	42EF-P2MPB-F4				
			4-pin pico QD	42EF-P2MPB-Y4				
Light Operate	N-MOSFET① 100 mA 8.3 ms	2 m 300V cable	42EF-P2SCB-A2					
		4-pin AC micro	42EF-P2SCB-G4					
		2 m 300V cable	42EF-P2RCB-A2					
		4-pin AC micro	42EF-P2RCB-G4					

① P-MOSFET models are available. Refer to www.ab.com/sensors.

ATTENTION



P-MOSFET models have a lower in-rush current threshold for short-circuit protection than N-MOSFET. Therefore, they may be susceptible to false trigger of short-circuit protection due to induced noise.

Refer to page 1-39 for cordsets and accessories.

Product Selection (continued)

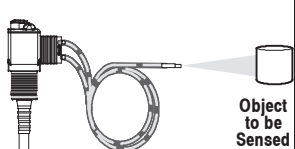
Sensing Mode	Current @ Voltage	Sensing Distance	Adjustment Type	Output Energized	Output Type/ Capacity Response Time	Connection Type	Cat. No.	
 <p>Large Aperture Fiber Optic (See Note 3.)</p> <p>Field of View: Depends on Glass Fiber Optic cable selected</p> <p>Emitter LED: Infrared 880nm</p>	35 mA @ 10.8...30V DC	Depends on Glass Fiber Optic cable selected	Single-Turn Knob	Dark Operate	NPN and PNP 100 mA 1 ms	2 m 300V cable	42EF-G1KBA-A2	
				Light Operate		4-pin DC micro	42EF-G1KBA-F4	
				Complementary Light and Dark Operate	NPN 100 mA 1 ms	2 m 300V cable	42EF-G1MNA-A2	
						4-pin DC micro	42EF-G1MNA-F4	
					PNP 100 mA 1 ms	4-pin pico	42EF-G1MNA-Y4	
						2 m 300V cable	42EF-G1MPA-A2	
	15 mA @ 21.6...264V AC/DC				Light Operate	N-MOSFET 100 mA 8.3 ms	4-pin AC micro	42EF-G1RCA-G4
					Dark Operate		2 m 300V cable	42EF-G1SCA-A2
					4-pin AC micro	42EF-G1RCA-A2		
					4-pin AC micro	42EF-G1SCA-G4		

ⓘ P-MOSFET models are available. Refer to www.ab.com/sensors.

ATTENTION



P-MOSFET models have a lower in-rush current threshold for short-circuit protection than N-MOSFET. Therefore, they may be susceptible to false trigger of short-circuit protection due to induced noise.

Note 1: For color registration mark applications, refer to light source selection guide at www.ab.com/sensors.

Note 2: For maximum performance, transmitted beam sources should be combined with matched operating voltage receivers, i.e., AC/DC source with AC/DC receiver or DC source with DC receiver. Reduced operating distance and margin will result from mixed operating voltage pairs.

Note 3: For use with glass fiber optic cables. See page 1-231 for more information.

Cordsets and Accessories

Description	Cat. No.	Description	Cat. No.	Description	Cat. No.
DC Micro QD Cordset, Straight, 4-pin, 2 m	889D-F4AC-2	76 mm (3 in.) Diameter Reflector	92-39	Apertures, 1 mm Slot	60-2660
AC Micro QD Cordset, Straight, 4-pin, 2 m	889R-F4AEA-2	32 mm (1.25 in.) Diameter Reflector	92-47	Apertures, 2 mm Slot	60-2661
Pico QD Cordset, Straight, 4-pin, 2 m	889P-F4AB-2	Mounting Bracket Swivel/Tilt	60-2649	Apertures, 4 mm Slot	60-2662
				Aperture Set	60-2659
Bifurcated Fiber Optic Cable—38 mm (1.5 in.) typical range	43GR-TBB25SL	Individual Fiber Optic Cable—457 mm (18 in.) typical range	43GT-FAS25SL		
Bifurcated Fiber Optic Cable—21 mm (0.8 in.) typical range	43GR-TFS10ML	Individual Fiber Optic Cable—152 mm (6 in.) typical range	43GT-TFS10ML		

Glass Fiber Optic Cables

