



Bulletin 194R Next Generation Global Fused and Non-Fused Disconnects

- 20 A...63 A Sizes
- Fused switch versions:
 - BS88 - DIN
 - CSA HRCII-C - CSA HRCI-MISC
 - UL Class J - UL Class CC
 - NFC
- Non-fused switches
- Operating handle ingress ratings:
 - IP42 (Type 1)
 - IP66 (Type 3R, 3, 12, 4, 4X)
- Handle with or without test mode
- Padlockable handle for up to three padlocks
- Up to 6 auxiliary contacts can be added per switch
- Suitable as service entrance disconnecting means (UL 98)
- Suitable as at-motor disconnecting means (UL 508)

Certifications

UL Listed (File No. E 14841, Guide NLRV; File No. E 47426, Guide WHTY)
 CSA Certified (File No. LR1234)
 CE

Table of Contents

Product Selection —
 Open Switches this page
 NFPA 79 Operating
 Shaft/Handle Kits..... 2-461
 Specifications..... 2-463
 Proper Selection of
 Disconnect Switches 2-473
 Fuse Description 2-474

Standards Compliance

IEC 60947/EN60947-3
 BS EN60947-3
 VDE 0660
 CSA 22.2 No. 4
 NEMA KS-1
 UL 98
 UL 508

The Bulletin 194R line of fused and non-fused global disconnect switches provides the flexibility to meet worldwide applications. These rod-operated disconnect switches incorporate removable fuse carriers that have high short circuit protection ratings. The disconnect switches are UL Listed and CSA Certified and are designed to meet IEC 60947-3, VDE, DIN, BS and applicable NEMA requirements.

Product Selection — Open Switches

Catalog Number Explanation



Cat. No. 194R-J30-1753

194R - J 30 - 1753 S
 a b c d

a

Fuse Type	
Code	Description
C	UL Class CC, CSA Type HRCI-MISC (30 A)
J	UL Class J, CSA Type HRCI-J (30 A or 60 A)
H	CSA Type HRCII-C (30 A or 60 A)
B	BS88 (20 A, 32 A, or 63 A)
D	DIN (32 A or 63 A)
F	NFC (25 A, 32 A, or 63 A)
N	Non-fused (30 A or 60 A)

b

Load Size		
Code	Description	Dimensional Ref.
20	20 A (BS88)	A1
25	25 A (NFC)	A1
30	30 A (CC, J, HRCI-J)	A1
	30 A (non-fused) *	A2
	30 A (HRCII-C)	B1
32	32 A (BS88, NFC)	A1
	32 A (DIN)	B1
60	60 A (J, HRCI-J, HRCII-C)	B1
60	60 A (non-fused) *	B2
63	63 A (BS88, DIN, NFC)	B1

c

No. of Poles	
Code	Description
1753	3-pole switch

d

Fuse Indication	
Code	Configuration
Blank	No fuse status indication
S	Fuse status indication

* See page 2-469 for dimensional reference data.

* Non-fused disconnect switches must use separately installed fuses for upstream short-circuit protection

Fourth pole, additional auxiliary contacts and handle options available in accessory section.

Limit of 6 total auxiliary contact blocks total for test and standard positions.



UL/CSA Fused Disconnect Switches



Cat. No. 194R-J30-1753

2

Rated Current [A]	Maximum Hp Ratings *							Fuse	Dim. Ref.	Cat. No.
	1-Phase (60 Hz)		3-Phase (60 Hz)			DC				
	120V	240V	240V	480V	600V	125V	250V			
UL Class CC and CSA HRCI-MISC Fuses										
30	2	3	7.5	15	20	3	5	30 A CC, HRCI-Misc	A1	194R-C30-1753
UL Class J and CSA HRCI-J Fuses										
30	2	3	7.5	15	20	3	5	30 A Class J, HRCI-J	A1	194R-J30-1753
60	3	10	15	30	50	5	10	60 A Class J, HRCI-J	B1	194R-J60-1753
CSA HRCII-C Fuses										
30	2	3	7.5	15	20	3	5	30A HRCII-C	B1	194R-H30-1753
60	3	10	15	30	50	5	10	60A HRCII-C	B1	194R-H60-1753

* Time delay fuses may be required to utilize the disconnect switch at its maximum horsepower rating.

Non-Fused Disconnect Switches



Cat. No. 194R-N30-1753



Non-Fused										
Fuse Description	Rated Current*	Maximum Hp Ratings							Dim. Ref.	Cat. No.
		1-Phase (60 Hz)		3-Phase (60 Hz)			DC			
		120V	240V	240V	480V	600V	125V	250V		
Non-fused disconnect switches must use separately installed fuses for upstream short circuit protection.	30	2	3	7.5	15	20	3	5	A2	194R-N30-1753
	60	3	10	15	30	40	5	10	B2	194R-N60-1753

* 30 A UL-rated device has I_{the} of 40 A per IEC. 60 A UL-rated device has I_{the} of 80 A per IEC.

IEC Fused and Non-Fused Disconnects, 30 & 60 A

Product Selection

Operating Handles (Accepts 3 Padlocks)

	For Use With	Description	Color	Degree of Protection	Cat. No.
	A1, A2, B1, B2	Test mode handle with defeater	Black	(Type 3R, 3, 12, 4, 4X) IP66	194R-HST4
			Red/Yellow	(Type 3R, 3, 12, 4, 4X) IP66	194R-HST4E
	A1, A2, B1, B2	Standard handle with defeater	Black	(Type 1) IP42	194R-HS1
			Red/Yellow	(Type 1) IP42	194R-HS1E
		Standard handle without defeater	Black	(Type 3R, 3, 12, 4, 4X) IP66	194R-HS4
			Red/Yellow	(Type 3R, 3, 12, 4, 4X) IP66	194R-HS4E
			Black	(Type 1) IP42	194R-HS1-N2
			Red/Yellow	(Type 1) IP42	194R-HS1E-N2
Black	(Type 3R, 3, 12, 4, 4X) IP66	194R-HS4-N2			
Red/Yellow	(Type 3R, 3, 12, 4, 4X) IP66	194R-HS4E-N2			

2

OSHA Lockout/Tag Out Compliance (LOTO)

OSHA CFR36 Section 1910 mandates that disconnects be able to be locked out while in the OFF position during servicing. All Bulletin 194R handles comply with this important safety requirement.



(Please see NFPA Article 430 for disconnect requirements of motor applications)

Operating Shafts

	Disconnect Switch Dim. Ref.	Operating Shaft Type	Operating Shaft Length Approx. Dim. [mm (in.)]	Enclosure Working Depth			Cat. No.
				Disconnect Switch Dim. Ref.	Minimum Approx. Dim. [mm (in.)]	Maximum Approx. Dim. [mm (in.)]	
	A1, A2, B1, B2	Standard Length	263 (10.3)	A1, B1	148 (5.8)	260 (10.2)	194R-R1
				A2, B2	111 (4.4)	260 (10.2)	
		Extended Length	457 (18.0)	A1, B1	148 (5.8)	454 (17.8)	194R-R2
				A2, B2	111 (4.4)	454 (17.8)	







NFPA 79 Operating Shaft/Handle Kits

An internal handle that permits operation of the disconnect switch when the panel door is open, in compliance with NFPA 79.

	Description	Shaft Length [mm (in.)]	Disconnect Switch Dim Ref.	Pkg. Qty.	Cat. No.
	NFPA 79 Handle Kit Includes NFPA 79 handle, operating shaft, and Cat. No. 194R-PLA1 padlocking attachment	305 (12)	A1, A2, B1, B2	1	194R-NHR1
		533 (21)	A1, A2, B1, B2	1	194R-NHR2

Other Accessories

	Description	Disconnect Switch Dim Ref.	Pkg. Qty.	Cat. No.
	Operating Shaft Guide — Allows easier coupling of shaft to operating handle if misalignment occurs between switch and enclosure after assembly installation	A1, A2, B1, B2	1	194R-HSG1
	Shaft Guard — Provides extra protection against contact with shaft	A1, A2, B1, B2	1	194R-R1G
	Operating Shaft Coupler — Used with Cat. Nos. 194R-R1 and 194R-R2 shafts to extend shaft length an additional 4.75 in.	A1, A2, B1, B2	1	194R-SC1
	Operating Handle Instruction Label — Describes the function of the operating handle for opening the enclosure door with the disconnect switch in the ON and OFF position	ALL	10	194R-L1



Replacement Mounting Hardware

	Pkg. Qty.	Description	For Use With	Cat. No.
	2	(1) M4 x .7 set screw, (1) shaft clip and (2) M4 x .7 mounting screws	A1, A2	194R-30-HDWR
	4	(1) M4 x .7 set screw, (1) shaft clip and (4) M4 x .7 mounting screws	B1, B2	194R-60-HDWR

Replacement Fuse Hardware

Description	For Use With	Pkg. Qty.	Cat. No.
M4 x .7 Fuse screws	194R BS88 Fuse Types	2	194R-BS88-M4
M5 x .6 Fuse screws	194R BS88 Fuse Types	2	194R-BS88-M5

Terminal Shields

	Description	Disconnect Switch Dim Ref.	Quantity Required Per Disconnect Switch	Pkg. Qty.	Cat. No.
	30 A Terminal Shield (three terminals)	A1, A2	2	2	194R-30-C3
	60 A Terminal Shield (three terminal)	B1, B2	2	2	194R-60-C3
	30 A Terminal Shield (one terminal)	A1, A2	2	2	194R-30-C1
	60 A Terminal Shield (one terminal)	B1, B2	2	2	194R-60-C1

* For use on either line or load side of disconnect switch.





Disconnect Switch Padlock Accessory

	Disconnect Switch Dim Ref.	Pkg. Qty.	Cat. No.†
	A1, A2, B1, B2	1	194R-PLA1

† For padlock with ø 3...6 mm

Replacement Fuse Carriers

2

	Description	Pkg. Quantity	Cat. No.*
 <p>194R-J30-FC</p>  <p>194R-J30-FCS</p>	30 A CC Fuse Carrier	1	194R-C30-FC
	30 A J Fuse Carrier	1	194R-J30-FC
	60 A J Fuse Carrier	1	194R-J60-FC
	20 A BS88 Fuse Carrier	1	194R-B20-FC
	32 A BS88 Fuse Carrier	1	194R-B32-FC
	63 A BS88 Fuse Carrier	1	194R-B63-FC
	30 A CSA HRCII-C Fuse Carrier	1	194R-H30-FC
	60 A CSA HRCII-C Fuse Carrier	1	194R-H60-FC
	32 A DIN Fuse Carrier	1	194R-D32-FC
	63 A DIN Fuse Carrier	1	194R-D63-FC
	25 A NFC Fuse Carrier	1	194R-F25-FC
	32 A NFC Fuse Carrier	1	194R-F32-FC
	63 A NFC Fuse Carrier	1	194R-F63-FC
	30 A Non-Fuse Carrier	1	194R-N30-FC
	60 A Non-Fuse Carrier	1	194R-N60-FC

* For fuse status indication add **S** to catalog number, example: 194R-J30-FC becomes 194R-J30-FCS.

Auxiliary Contact Blocks*

	Description	Contact Material	Pkg. Quantity	Cat. No.
 <p>Cat. No. 800F-X10</p>	Contact Block Note: Sold only in multiples of 10. Order (quantity of) 10 to receive one package of 10 pieces. Latch not included.	N.O.	10	800F-X10
		N.C.		800F-X01
		N.O.E.M.		800F-X10E
		N.C.L.B.		800F-X01L
		N.O. with stab terminals		800F-X10T
		N.C. with stab terminals		800F-X01T
		N.O. spring-clamp		800F-Q10
		N.C. spring-clamp		800F-Q01

* Also used for test mode function.

Multi-tap Lugs

	Description	Wire Size	Dimension Reference	Pkg. Quantity	Cat. No.
	Multi-Tap Terminal Lugs Load side only	(3) 14...4 AWG (3) 0.75...25 mm ²	A1 (194R-J30), A2 (194R-N30)	3	194R-30-MTL3
		(3) 14...4 AWG (3) 0.75...25 mm ²	B1 (194R-JG0), B2 (194R-NG0)	3	194R-60-MTL3

Fused Disconnect Switches For UL Class Fuses and CSA HRCI-J



Electrical Ratings							
Cat. No.		194R-C30-1753		194R-J30-1753		194R-J60-1753	
CSA Fuse Type/UL Fuse Type		Class CC/HRCI-MISC *		Class J/HRCI-J		Class J/HRCI-J	
Maximum Fuse Cartridge Size	[A]	30		30		60	
Maximum Voltage	AC [V] DC [V]	600 250		600 250		600 250	
Ampere Rating	[A]	30		30		60	
Maximum Short Circuit Prospective Fault Current	[kA]	200		200		200	
Fuse Operating Characteristics		Time Delay	Non-Time Delay	Time Delay	Non-Time Delay	Time Delay	Non-Time Delay
Maximum Hp, 3-Phase AC							
200V, 60 Hz	[Hp]	5	3	7.5	3	15	7.5
240V, 60 Hz	[Hp]	5	3	7.5	3	15	7.5
480V, 60 Hz	[Hp]	10	5	15	5	30	15
600V, 60 Hz	[Hp]	10	7.5	20	7.5	50	15
Maximum Hp, 1-Phase AC							
120V, 60 Hz	[Hp]	0.75	0.5	2	0.5	3	1.5
240V, 60 Hz	[Hp]	2	1.5	3	1.5	10	3
Maximum Hp, DC							
125V DC	[Hp]	2	3	3	2	5	5
250V DC	[Hp]	3	5	5	5	10	10

Mechanical Data					
Cat. No.		194R-C30-1753, 194R-J30-1753		194R-J60-1753	
Degree of Protection (per IEC 60947-3)					
Switch Only		IP20		IP20	
Switch with Terminal Shield & Fuse Carriers		IP20		IP20	
Mechanical Endurance ‡	Operations	10 000		10 000	
Operating Torque (Maximum)	N•m lb•in	3.5 35		3.5 35	
Terminal Capacity	mm ²	2.5...10		2.5...25	
Power Terminals	AWG	#14...#8		#14...#4	
Auxiliary Contact Terminals	mm ²	2.5...4		2.5...4	
	AWG	#14...#12		#14...#12	
Maximum Number of Auxiliary Circuits		6		6	
Approximate Weight	kg lbs	0.92 2.03		1.32 2.9	
Minimum Enclosure Size	Height	248 (9-3/4)		248 (9-3/4)	
Approximate dimensions in millimeters (inches)	Width	171 (6-3/4)		197 (7-3/4)	
	Depth	148 (5-13/16)		148 (5-13/16)	
Switch Dimension Reference (See dimension drawings.)		A1		B1	

* CSA HRCI-MISC fuses must also be UL Listed as Class CC fuses.

‡ Based on Rockwell Automation tests in accordance with the requirements as defined in CSA C22.2 No. 4, IEC 60947-3 and UL 98.

2

UL LISTED, CSA CERTIFIED	DIMENSION REFERENCE	CIRCUIT
Cat. No.		
194R-C30-1753	A1	
194R-J30-1753	A1	
194R-J60-1753	B1	
194R-H30-1753	B1	
194R-H60-1753	B1	
194R-N30-1753	A2	
194R-N60-1753	B2	

IEC SWITCHES	DIMENSION REFERENCE	CIRCUIT
Cat. No.		
194R-B20-1753	A1	
194R-B32-1753	A1	
194R-B63-1753	B1	
194R-D32-1753	B1	
194R-D63-1753	B1	
194R-F25-1753	A1	
194R-F32-1753	A1	
194R-F63-1753	B1	
194R-★-1754	(See 3-pole Dimension Reference) for Fused Switches	

IEC Fused and Non-Fused Disconnects, 30 & 60 A

Approximate Dimensions

Dimensions in millimeters (inches). Dimensions are not intended to be used for manufacturing purposes.

Disconnect Switch Dimension References A1, A2, B1, and B2 (30 A and 60 A)

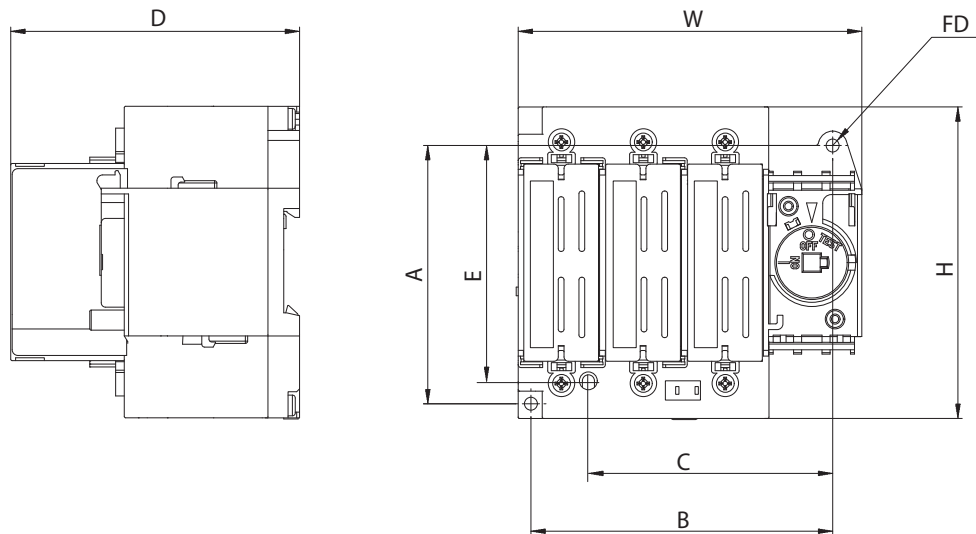

2

Disconnect Switch Dimension Reference	Approximate Dimensions mm (in)							
	H	W	D	A	B	C*	E*	FD
A1	108 (4-1/4)	120 (4-3/4)	101 (4)	90 (3-9/16)	105 (4-1/8)	85 (3-11/32)	82 (3-15/64)	2-M4, 2-#8
A2	108 (4-1/4)	120 (4-3/4)	80 (3-1/8)	90 (3-9/16)	105 (4-1/8)	85 (3-11/32)	82 (3-15/64)	2-M4, 2-#8
B1	113 (4-29/64)	142 (5-19/32)	114 (4-31/64)	100 (3-15/16)	120 (4-23/32)	N/A	N/A	4-M4, 4-#8
B2	113 (4-29/64)	142 (5-19/32)	93 (3-43/64)	100 (3-15/16)	120 (4-23/32)	N/A	N/A	4-M4, 4-#8

* Mounting holes for backward compatibility with Bulletin 194R legacy switches.

Operating Handles — Cat. No. 194R-HS.../HST

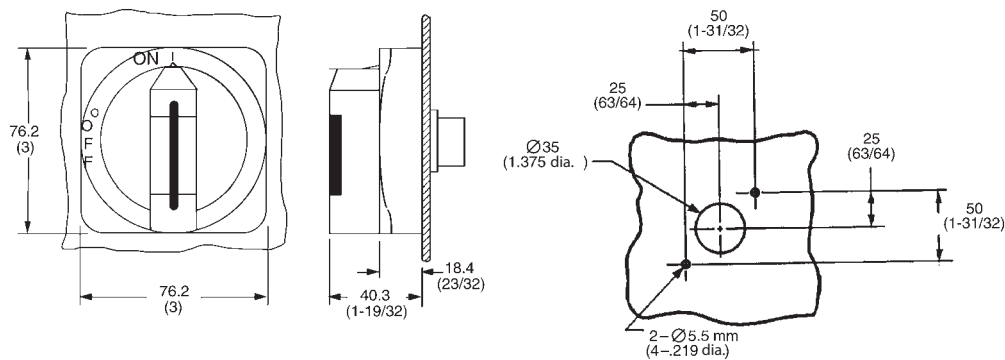

Proper Selection of Disconnect Switches

Applications Within Canada and the United States

General

The requirements for disconnect switches used in motor branch circuits rated 600V and less are defined in Article 430, Part J of the U.S. National Electrical Code (NEC), NFPA70. Canadian Electrical Code (CEC) requirements are very similar in the area of motor branch circuit disconnect requirements. For simplicity, we will treat the NEC and CEC requirements as being the same — and reference specific sections of the U.S. National Electrical Code.

The requirements for properly sizing a disconnect switch are dependent on the type of application. The NEC refers to two types of applications: single motor and combination loads. A combination load consists of an application where two or more motors are used together or where one or more motors are used in combination with other loads, such as resistance heaters.

Single Motor Applications

Section 430-110 Paragraph (a) states that the disconnect switch must have an ampere rating of at least 115% of the full-load current rating of the motor.

Example 1: For a motor with a full-load current of 22 A, the disconnect switch must be rated at least 25.3 A (22 x 1.15). If the disconnecting means under evaluation is rated in horsepower, the selection of the disconnect switch is even more straightforward; a disconnect switch must have a horsepower rating equal to, or greater than the horsepower rating of the motor at the applicable voltage.

Example 2: For a motor with a 10 Hp rating at 460V AC, the disconnect switch must be rated at least 10 Hp at 460V AC. If the disconnect switch is rated in horsepower, and UL Listed, UL Component Recognized, or CSA Certified, it will meet the requirements for the 115% full load current rating stipulated by the NEC.

Combination Load Applications

Section 430-110 Paragraph (c) addresses the rating of the disconnecting means for combination loads. This paragraph essentially requires that the loads that “may be simultaneous on a single disconnecting means” be combined to provide equivalent full-load and locked-rotor currents for what is then to be considered as a single motor for the purpose of selecting the appropriate disconnecting means. This means that it is necessary to identify the particular combination of connected loads which can be operating simultaneously and will result in the maximum full-load and locked-rotor current sums.

The individual full-load current values are to be selected from Tables 430-148, 430-149, or 430-150 and the locked-rotor values are to be from Table 430-151.

The equivalent single motor full-load current is the sum of the simultaneously operating motor full-load currents and the rating in amperes of other loads operating at the same time. The equivalent locked-rotor current is the sum of the simultaneously started motors' locked-rotor currents and the full-load currents of the remaining operating motor and non-motor loads.

The disconnecting means shall have a current rating equal to or greater than 115% of the equivalent single motor full-load current and have a horsepower rating equal to or greater than the horsepower rating determined from the equivalent locked-rotor summation.

Consider the following 460V application:

Load	Hp	Full-Load Current [A]
Motor 1	5	7.6 (simultaneous)
Motor 2	10	14.0 (not included)*
Motor 3	15	21.0 (simultaneous)
Motor 4	20	27.0 (simultaneous)
Other		7.0 (simultaneous)
Total Equivalent		62.6 (simultaneous)

* Motor 2 is not included in the total since it cannot operate simultaneously with the other motors, therefore, the disconnect switch must be rated at least 72 A (1.15 x 62.6).

Consider now the locked-rotor current analysis for the same application:

Load	Hp	Full-Load Current [A]
Motor 1	5	(7.6FLA) 45.6 (simultaneous)
Motor 2	10	84.0 (not included)*
Motor 3	15	126.0 (simultaneous)*
Motor 4	20	162.0 (simultaneous)*
Other		7.0 (simultaneous)
Total Equivalent		302.6 (simultaneous)

* Note again that Motor 2 cannot operate simultaneously with the other loads.

* The largest equivalent locked-rotor current occurs when motors 3 and 4 start together while the other loads marked “simultaneous” are already operating. Since Motor 1 is not starting with Motors 3 and 4, its full-load current will be added to the total instead of its locked-rotor current.

Table 430-151, which provides the correlation between locked-rotor currents and Hp ratings, shows that a 40 Hp rating is the equivalent for 302.6 locked-rotor amperes.

Therefore, the disconnect selected for this application must have a current rating of at least 72 A and a Hp rating of at least 40 Hp. In this case a Bulletin 194R rated for 100 A and 60 Hp at 460V would be an appropriate choice. What can be seen from this analysis is that, depending upon the number of motors that can start simultaneously, the actual size of the required disconnect is sometimes determined by the equivalent full load current (72 A) and other times by the equivalent horsepower determined from the locked rotor analysis (40 Hp).

Applications Outside the United States and Canada

General

Disconnect switches designed to IEC Standards and used in applications outside of North America are selected based on the ampere, horsepower, or kilowatt rating of the disconnect switch, under various utilization categories. Utilization categories for disconnect switches are as follows:

Nature of Current	Utilization Category		Typical Applications
	Frequent Operation	Infrequent Operation	
AC	AC-20A*	AC-20B*	Connecting and disconnecting under no load conditions
	AC-21A	AC-21B	Switching of resistive loads including moderate overloads
	AC-22A	AC-22B	Switching of mixed resistive and inductive loads, including moderate overloads
	AC-23A	AC-23B	Switching of motor loads or other highly inductive loads

* The use of these utilization categories is not permitted in the U.S.

For any application, the disconnect switch rating (A, Hp, or kW) must be greater than or equal to the application full-load current or power (Hp or kW), in the appropriate utilization category.

Example 1: For a 380V 50 Hz distribution application (AC-22A), with a 63 A full load current, the disconnect switch must be rated at least 63 A at 380V 50 Hz for use in AC-22A applications.

Example 2: For a 415V 50 Hz motor application (AC-23A), with a 75 kW rating, the disconnect switch must be rated at least 75 kW at 415V 50 Hz for use in AC-23A applications.

Fuse Description

With Bulletin 194R Fused Disconnect Switches

Bulletin 194R Fused Disconnect Switches have been designed to accept a variety of fuses for worldwide application flexibility. Following is a brief summary of typical fuse specifications, where the fuses are typically used, and which Bulletin 194R disconnect switches will accommodate each fuse type. Fuse manufacturers should be contacted for more specific information about each fuse type. **Fuses are not available from Rockwell Automation. BS88 Fuses (63 A shown)**

Dimensions in millimeters (inches). Dimensions are not intended to be used for manufacturing purposes.

- IEC fuse type: Fuse-link for bolted connection
- Voltage rating: 660/690V AC
- Interrupting rating: 80 kA
- Standard cartridge sizes: A1, A2, A3, A4, B1, B2, B3, B4
- Typical ampere ratings: 2...400 A
- Construction: Blade type for bolted connection
- Can be installed on Bulletin 194R disconnect switch
- **Cat. Nos: 194RNA100P3, NA200P3, NA300P3, NA380P3, NA400P3, NB200P3, NB300P3**
- Where used: United Kingdom, Australia, New Zealand, Asia

2

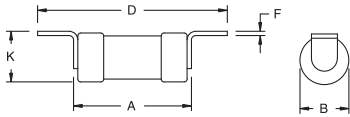

Standard cartridge size A1

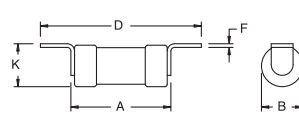

Standard cartridge sizes A2, A3, A4

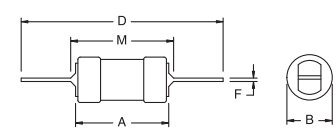

Standard cartridge sizes B1, B2, B3, B4

Dim. Ref.	Ampere Range [A]	A	B	D	E	F	G	H	K
A1	2...20	36.50 (1-7/16)	13.90 (35/64)	55.60 (2-3/16)	11.10 (7/16)	0.80 (1/32)	4.50 (1-3/4)	4.40 (11/64)	14.30 (9/16)

Dim. Ref.	Ampere Range [A]	A	B	D	E	F	G	H	J	K
A2	2...20	56.40 (2-7/32)	23.80 (15/16)	85.80 (3-3/8)	8.70 (11/32)	1.20 (3/64)	73.00 (2-7/8)	5.20 (13/64)	7.10 (9/32)	23.80 (15/16)
A3	35...63	56.40 (2-7/32)	23.80 (15/16)	85.80 (3-3/8)	8.70 (11/32)	1.20 (3/64)	73.00 (2-7/8)	5.20 (13/64)	7.10 (9/32)	23.80 (15/16)
A4	80...100	70.00 (2-3/4)	34.90 (1-3/8)	111.00 (4-3/8)	19.10 (3/4)	2.40 (3/32)	93.70 (3-11/16)	8.70 (11/32)	10.30 (13/32)	34.90 (1-3/8)

Dim. Ref.	Ampere Range [A]	A	B	D	E	F	G	H	J	M
B1	2...20	70.00 (2-3/4)	34.90 (1-3/8)	136.50 (5-3/8)	19.10 (3/4)	3.20 (1/8)	111.00 (4-3/8)	8.70 (11/32)	11.90 (15/32)	79.40 (3-1/8)
B2	125...200	77.00 (3-1/32)	41.30 (1-5/8)	136.50 (5-3/8)	19.10 (3/4)	3.20 (1/8)	111.00 (4-3/8)	8.70 (11/32)	11.90 (15/32)	79.40 (3-1/8)
B3	250...315	83.00 (3-9/32)	54.00 (2-1/8)	136.50 (5-3/8)	25.40 (1)	3.20 (1/8)	111.00 (4-3/8)	8.70 (11/32)	11.90 (15/32)	82.00 (3-1/4)
B4	355...400	70.00 (2-3/4)	61.10 (2-13/32)	136.50 (5-3/8)	25.40 (1)	6.30 (1/4)	111.00 (4-3/8)	8.70 (11/32)	11.90 (15/32)	85.80 (3-3/8)