

1492-SP Supplementary Protectors

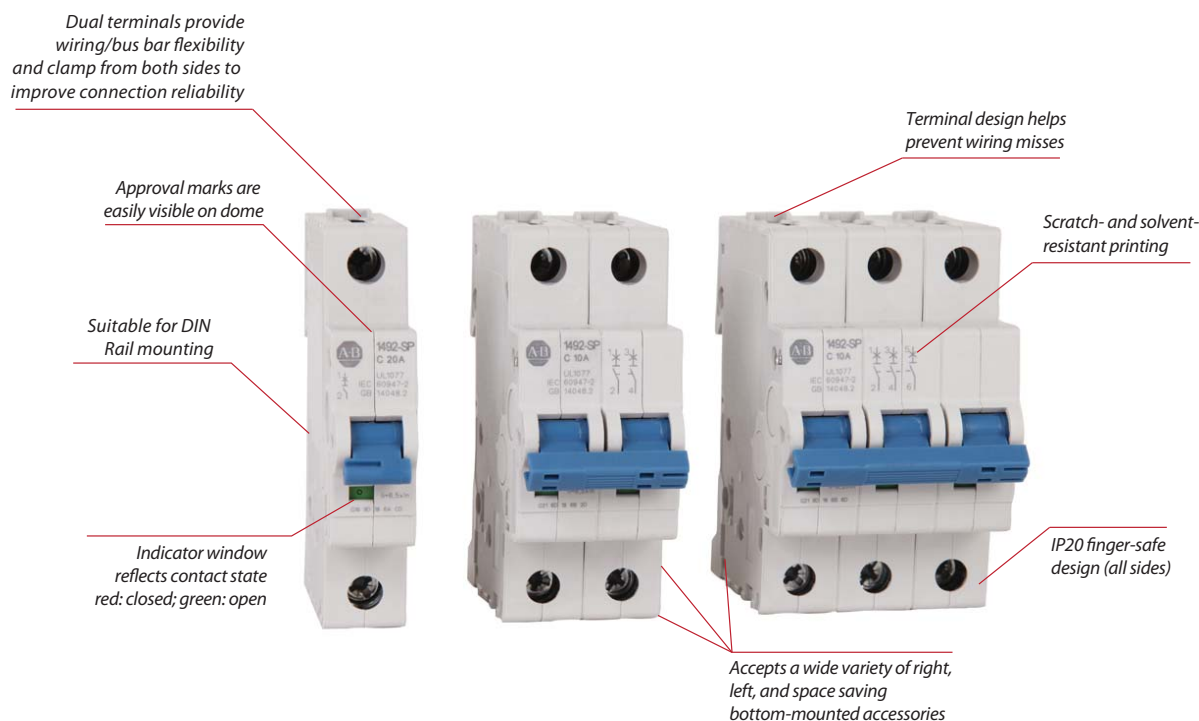

Bulletin 1492-SP thermal magnetic Supplementary Protectors provide overcurrent protection for equipment where branch circuit protection is already provided, or is not required. These devices are also Miniature Circuit Breakers as defined by IEC Standards.

These supplementary protectors are offered as a broad portfolio of pole variants, current ratings, and trip curves to match the appropriate level of protection for your application. They may be used with UL 508 Listed bus bars for convenience in panel assembly, a wide range of left-, right- and space saving bottom-mount accessories, and lock out attachments for safety during maintenance.

Features

- Current limiting
- Fast breaking time
- Existing installations can be easily upgraded to include an auxiliary using the bottom mounted auxiliary contact options, which require no DIN Rail space
- 40 °C calibration temperature (UL/CSA) eliminates need to derate for 508A industrial control panel installations
- Installation of up to six accessories on the same circuit breaker
- Superior shock and vibration resistance to prevent nuisance tripping
- Dual terminals allow a more secure connection of two wires, or both a wire and bus bar
- Terminal design helps prevent wiring misses by directing wires into the terminal openings, even while tightening
- Reversible line and load connections
- Single and multi-pole toggle mount lock out attachments available for Lockout/Tagout (LOTO)
- RoHS compliant and fully-recyclable device
- Suitable for extreme ambient conditions

1492-SP Supplementary Protectors

Rated Voltage	UL/CSA: Max. 480Y/277V AC IEC: U_e 230/400V AC
Interrupting Capacity	UL/CSA: 5...10 kA IEC: 15 kA
Current Ratings	0.5...63 A
Poles	1, 2, 3, 1+N, 3+N
Trip Curves	B, C, D
Standards Compliance	UL 1077 CSA C22.2 No. 235 EN 60947-2 GB 14048.2
Certifications	UL Recognized, File No. E65138 ★ CSA Certified, File No. 259391 CE Marked CCC Certified VDE Certified RoHS Compliant

* 1+N and 3+N devices are not UL recognized or CSA certified.

Catalog Number Explanation

Note: Examples given in this section are for reference purposes. This basic explanation should not be used for product selection; some combinations may not produce a valid catalog number.

1492 - **SPM** **1** **C** **010** - **N**
a *b* *c* *d* *e*

a

Voltage Type	
Code	Description
SPM	AC Supplementary Protector

b

Poles	
Code	Description
1	1-Pole
2	2-Pole
3	3-Pole

c

Trip Curve	
Code	Trip Curve
B	Trip Curve B
C	Trip Curve C
D	Trip Curve D

d

Rated Current (I_n)	
Code	Current [A]
005	0.5
010	1
020	2
030	3
040	4
050	5
060	6
070	7
080	8
100	10
130	13
150	15
160	16
200	20
250	25
300	30
320	32
400	40
500	50
630	63

e

+ Neutral (available for 1+N and 3+N configurations)	
Code	Description
	Can be left blank
N	+ Neutral

Product Selection

2-Pole Supplementary Protectors

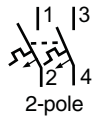
Photo/Wiring Diagram	Continuous Current Rating (I_n) [A]	Trip Curve B Resistive or Slightly Inductive $3...5 I_n$ Cat. No.	Trip Curve C Inductive $5...10 I_n$ Cat. No.	Trip Curve D Highly Inductive $10...20 I_n$ Cat. No.
	0.5	1492-SPM2B005	1492-SPM2C005	1492-SPM2D005
	1	1492-SPM2B010	1492-SPM2C010	1492-SPM2D010
	2	1492-SPM2B020	1492-SPM2C020	1492-SPM2D020
	3	1492-SPM2B030	1492-SPM2C030	1492-SPM2D030
	4	1492-SPM2B040	1492-SPM2C040	1492-SPM2D040
	5	1492-SPM2B050	1492-SPM2C050	1492-SPM2D050
	6	1492-SPM2B060	1492-SPM2C060	1492-SPM2D060
	7	1492-SPM2B070	1492-SPM2C070	1492-SPM2D070
	8	1492-SPM2B080	1492-SPM2C080	1492-SPM2D080
	10	1492-SPM2B100	1492-SPM2C100	1492-SPM2D100
	13	1492-SPM2B130	1492-SPM2C130	1492-SPM2D130
	15	1492-SPM2B150	1492-SPM2C150	1492-SPM2D150
	16	1492-SPM2B160	1492-SPM2C160	1492-SPM2D160
	20	1492-SPM2B200	1492-SPM2C200	1492-SPM2D200
	25	1492-SPM2B250	1492-SPM2C250	1492-SPM2D250
	30	1492-SPM2B300	1492-SPM2C300	1492-SPM2D300
	 <p>2-pole</p>	32	1492-SPM2B320	1492-SPM2C320
40		1492-SPM2B400	1492-SPM2C400	1492-SPM2D400
50		1492-SPM2B500	1492-SPM2C500	1492-SPM2D500
63		1492-SPM2B630	1492-SPM2C630	1492-SPM2D630

Specifications

Electrical Ratings			
Poles	1, 2, 3, 1+N, 3+N		
Tripping characteristics	B, C, D		
Rated current (I_n)	0.5...63 A		
Rated frequency (f)	50/60 Hz		
Rated insulation voltage U_i per IEC/EN 60664-1	250 V AC (phase to ground), 440V AC (phase to phase)		
Overvoltage category	III		
Pollution degree	3		
Data per UL/CSA			
Rated voltage	1-pole	AC	277V AC
		DC	48V DC
	2-pole	AC	480Y/277V AC
		DC	96V DC
	3-pole	AC	480Y/277V AC
	Rated interrupting capacity per UL 1077	≤ 32 A: 10 kA (AC); > 32 A: 5 kA (AC); 0.5...63 A: 10 kA (DC)	
Application	Supplementary Protector for general use; application codes: TC1, OL0, SC: U2 (AC), SC: U2 (DC), FW3 \clubsuit		
Reference temperature for tripping characteristics	40 °C		
Electrical endurance	6,000 ops (AC), 6,000 ops. (DC) 1 cycle (1s - ON, 9s - OFF)		
Data per IEC/EN 60947-2			
Rated operational voltage (U_e)	1-pole, 1+N	230V AC	
	2-pole, 3-pole, 3+N	400V AC	
Highest supply or utilization voltage (U_{max})	AC	1-pole, 1+N	253V AC
		2-pole, 3-pole, 3+N	440V AC
	DC \star	1-pole	48V DC
		2-pole	96V DC
Min. operating voltage	12V AC, 12V DC		
Rated ultimate short-circuit breaking capacity (I_{CU})	15 kA		
Rated service short-circuit breaking capacity (I_{CS})	≤ 40 A: 11.25 kA > 40 A: 7.5 kA		
Rated impulse withstand voltage U_{imp} . (1.2/50 μ s)	4 kV (test voltage 6.2kV at sea level, 5kV at 2,000m)		
Dielectric test voltage	2 kV (50/60Hz, 1 min.)		
Reference temperature for tripping characteristics	30 °C		
Electrical endurance	$I_n < 30$ A: 20,000 ops (AC) 1 cycle (2s - ON, 13s - OFF, $I_n \leq 32$ A), $I_n \geq 30$ A: 10,000 ops. (AC) 1 cycle (2s - ON, 28s - OFF, $I_n > 32$ A) 1,000 ops. (DC)		

\star IEC DC ratings self-declared.

\clubsuit 2-pole/3-pole single pole load: TC2.

Mechanical Data	
Housing	Insulation group II, RAL 7035
Indicator window	red ON/green OFF
Protection degree per EN 60529	IP20, IP40 in enclosure with cover
Mechanical endurance	20,000 operations
Shock resistance per IEC/EN 60068-2-27	25 g - 2 shocks - 13 ms
Vibration resistance per IEC/EN 60068-2-6	5g - 20 cycles at 5...150...5 Hz with load 0.8In

Environmental	
Environmental conditions (damp heat) per IEC/EN 60068-2-30	28 cycles with 55°C/90-96% and 25°C/95-100%
Ambient temperature Δ	-25...+55 °C
Storage temperature	-40...+70 °C

Installation		
Terminal	Dual terminal	
Cross-section of conductors \blacklozenge – solid, stranded (front/back terminal slot)	mm ²	35/35 mm ²
	AWG	18...4/18...10 AWG
Cross-section of conductors – flexible (front/back terminal slot)	mm ²	25/10 mm ²
Cross-section of bus bars (back terminal slot)	mm ²	10 mm ²
Tightening torque	N•m	2.8 N•m
	in•lb.	AWG 18...16: 8.85 in•lb. AWG 14...10: 17.7 in•lb. AWG 8...4: 39.8 in•lb.
Screwdriver	No. 2 Pozidrive	
Mounting	DIN rail (EN 60715, 35mm) with fast clip	
Mounting position	Any	
Supply	Optional	

Approximate Dimensions and Weight	
Pole dimension (H x D x W)	88 x 69 x 17.5 mm
Pole weight	115 g (4.1 oz.)

Combination with Auxiliary Elements	
Auxiliary contact	Yes
Signal contact	Yes
Shunt trip	Yes

\blacklozenge 35mm² self-declared, not included in IEC/EN approval.

Δ Refer to the ambient temperature derating tables.

Power Loss Due to Current

Rated Current [A]	Power Loss Per Pole [W]	Rated Current [A]	Power Loss Per Pole [W]
0.5	1.4	13	2.3
1	1.4	15	2.4
2	1.8	16	2.5
3	1.6	20	2.5
4	1.8	25	3.2
5	1.9	30	3.5
6	2.0	32	3.7
7	1.1	40	4.5
8	1.5	50	4.5
10	2.1	63	5.4

Zero-stack Derating

The installation of several miniature circuit breaker side by side with rated current on all poles requires a correction factor to the rated current (not required if spacers are used).

No. of Adjacent Devices	Factor
1	1
2,3	0.9
4,5	0.8
≥ 6	0.75

Approximate Dimensions

Note: Dimensions are shown in millimeters (inches). Dimensions are not intended for manufacturing purposes.

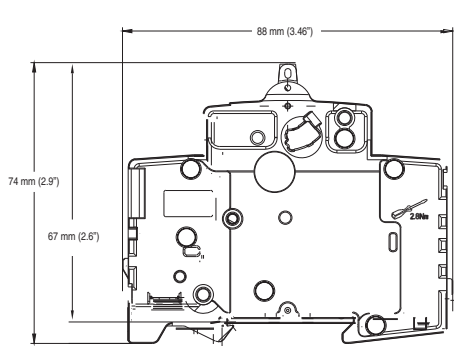

1-Pole

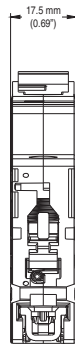

1-Pole

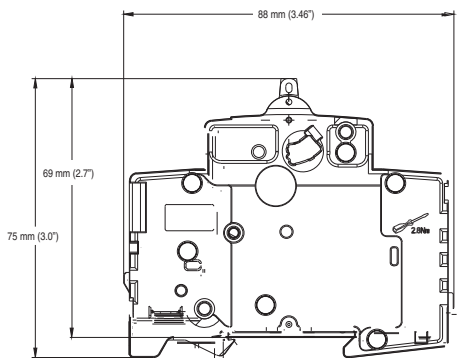

1 Pole + N, 2-, 3-, 3 Pole + N

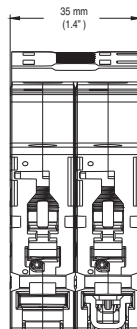

1 Pole + N, 2-Pole

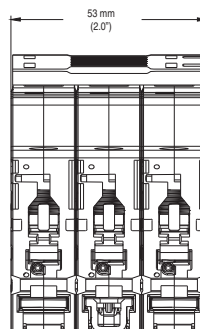

3-Pole

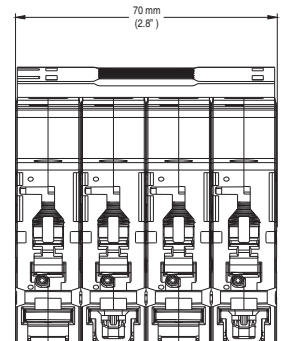

3-Pole + N

Ambient Temperature Derating

Note: Application below 0° C is for non-condensing atmosphere. Care should be taken for applications below 0 °C. These devices are not certified to operate correctly in the presence of ice.

Bulletin 1492-SP

Temperature Derating, UL

Reference temperature = 40 °C

Current Rating [A]	Ambient temperature (°C)									
	-25	-20	-10	0	10	20	30	40	50	55
0.5	0.6	0.6	0.6	0.6	0.6	0.5	0.5	0.5	0.5	0.5
1	1.2	1.2	1.2	1.1	1.1	1.1	1.0	1	1.0	0.9
2	2.5	2.4	2.4	2.3	2.2	2.1	2.1	2	1.9	1.9
3	3.7	3.7	3.6	3.4	3.3	3.2	3.1	3	2.9	2.8
4	5.0	4.9	4.7	4.6	4.4	4.3	4.1	4	3.9	3.8
5	6.2	6.1	5.9	5.7	5.6	5.4	5.2	5	4.8	4.7
6	7.4	7.3	7.1	6.9	6.7	6.4	6.2	6	5.8	5.7
7	8.7	8.6	8.3	8.0	7.8	7.5	7.3	7	6.7	6.6
8	9.9	9.8	9.5	9.2	8.9	8.6	8.3	8	7.7	7.6
10	12.4	12.2	11.9	11.5	11.1	10.7	10.4	10	9.6	9.4
13	16.1	15.9	15.4	14.9	14.4	14.0	13.5	13	12.5	12.3
15	18.6	18.3	17.8	17.2	16.7	16.1	15.6	15	14.4	14.2
16	19.8	19.6	19.0	18.4	17.8	17.2	16.6	16	15.4	15.1
20	24.8	24.4	23.7	23.0	22.2	21.5	20.7	20	19.3	18.9
25	31.0	30.6	29.6	28.7	27.8	26.9	25.9	25	24.1	23.6
30	37.2	36.7	35.6	34.4	33.3	32.2	31.1	30	28.9	28.3
32	39.7	39.1	37.9	36.7	35.6	34.4	33.2	32	30.8	30.2
40	49.6	48.9	47.4	45.9	44.4	43.0	41.5	40	38.5	37.8
50	62.0	61.1	59.3	57.4	55.6	53.7	51.9	50	48.2	47.2
63	78.2	77.0	74.7	72.3	70.0	67.7	65.3	63	60.7	59.5

Bulletin 1492-SP

Temperature Derating, IEC

Reference temperature = 30 °C

Current Rating [A]	Ambient temperature (°C)									
	-25	-20	-10	0	10	20	30	40	50	55
0.5	0.6	0.6	0.6	0.5	0.5	0.5	0.5	0.5	0.5	0.5
1	1.2	1.2	1.1	1.1	1.1	1.0	1	1.0	0.9	0.9
2	2.3	2.3	2.2	2.2	2.1	2.1	2	1.9	1.9	1.9
3	3.5	3.5	3.4	3.3	3.2	3.1	3	2.9	2.8	2.8
4	4.7	4.6	4.5	4.4	4.2	4.1	4	3.9	3.8	3.7
5	5.8	5.8	5.6	5.5	5.3	5.2	5	4.9	4.7	4.6
6	7.0	6.9	6.7	6.5	6.4	6.2	6	5.8	5.6	5.6
7	8.2	8.1	7.8	7.6	7.4	7.2	7	6.8	6.6	6.5
8	9.3	9.2	9.0	8.7	8.5	8.2	8	7.8	7.5	7.4
10	11.7	11.5	11.2	10.9	10.6	10.3	10	9.7	9.4	9.3
13	15.1	15.0	14.6	14.2	13.8	13.4	13	12.6	12.2	12.0
15	17.5	17.3	16.8	16.4	15.9	15.5	15	14.6	14.1	13.9
16	18.6	18.4	17.9	17.4	17.0	16.5	16	15.5	15.0	14.8
20	23.3	23.0	22.4	21.8	21.2	20.6	20	19.4	18.8	18.5
25	29.1	28.8	28.0	27.3	26.5	25.8	25	24.3	23.5	23.1
30	35.0	34.5	33.6	32.7	31.8	30.9	30	29.1	28.2	27.8
32	37.3	36.8	35.8	34.9	33.9	33.0	32	31.0	30.1	29.6
40	46.6	46.0	44.8	43.6	42.4	41.2	40	38.8	37.6	37.0
50	58.3	57.5	56.0	54.5	53.0	51.5	50	48.5	47.0	46.3
63	73.4	72.5	70.6	68.7	66.8	64.9	63	61.1	59.2	58.3

Tripping Characteristics

B Curve

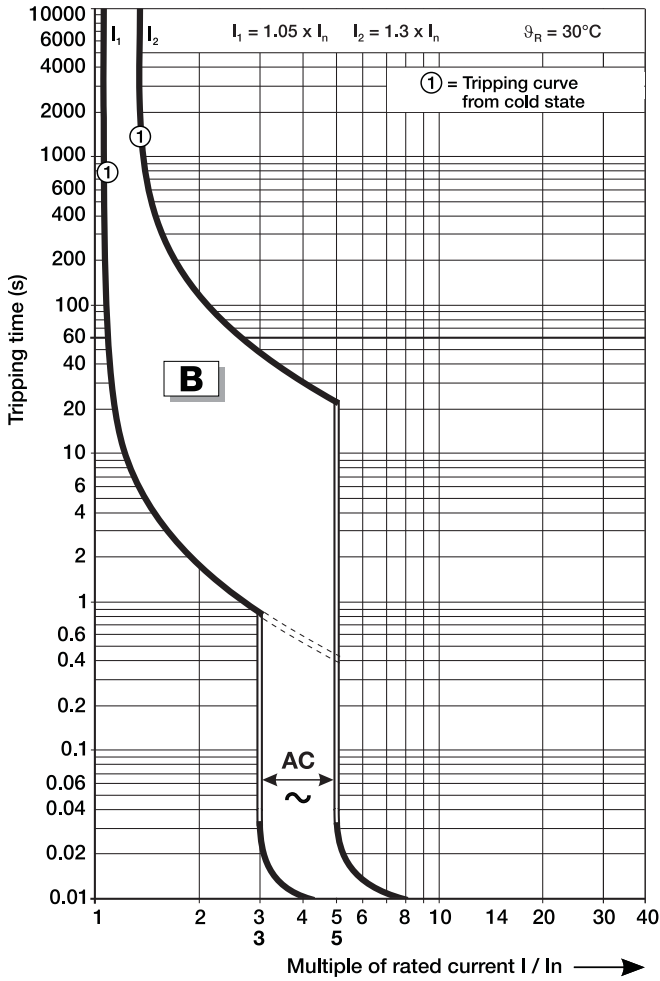

B and C Curve - 230/400V AC Let-through Energy

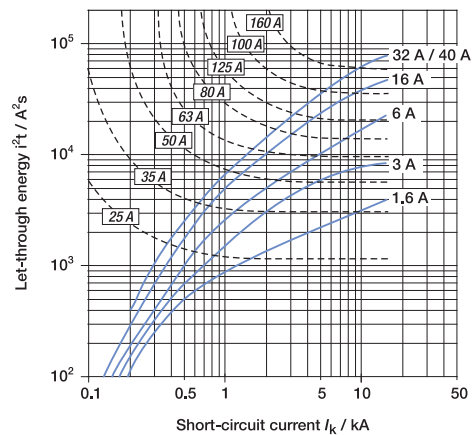
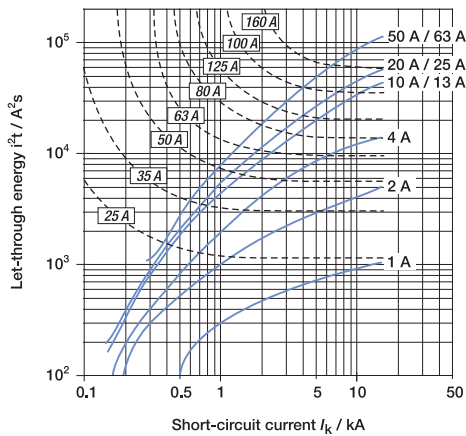

Tripping Characteristics

C Curve

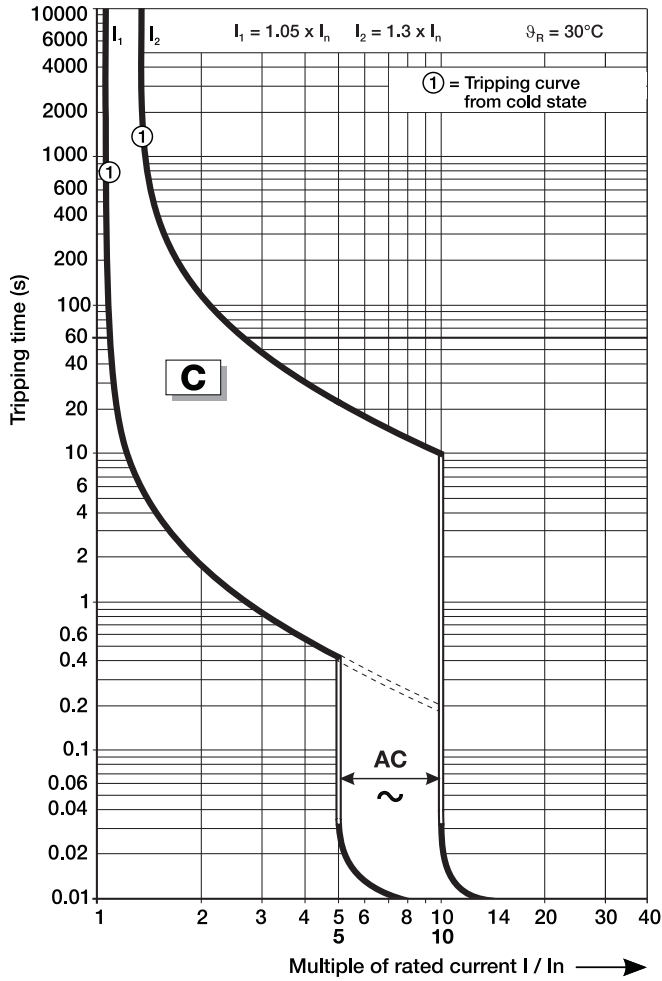

B and C Curve - 230/400V AC Let-through Energy

