

FEATURES & SPECIFICATIONS

INTENDED USE — Recessed housing rated IC or Non-IC. For new construction only.

Approved for all ceiling and wiring types.

Approved for direct burial in insulation.

CONSTRUCTION — Air-Tight standard. Tested to meet current energy codes.

Aluminum housing with galvanized steel pan.

Galvanized bar hangers span up to 24" o.c. and feature built in nailer and integral T-bar clips. Two locking screws hold fixture in position.

Galvanized steel junction box with four built-in Romex clamps; five 1/2" and two 3/4" nominal knockouts with slots for pryout. Rated for through branch wiring.

Maximum 4 (2 in, 2 out) No 12 AWG conductors. Rated for 90° C.

Ground wire provided.

Removable J-box doors for easy access.

Trim retention (clips): Retaining clips riveted to top of reflector hold trim inside housing.

Trim retention (TOR): Two-side mounted torsion springs on the trim and 2 receiving brackets in the can ensure a consistently tight fit with the ceiling.

ELECTRICAL — Durable medium base porcelain socket with nickel plated copper alloy screw shell and contact.

Socket clips to top of housing to prevent paint overspray in socket screw shell.

Socket attaches to reflector to ensure proper and consistent lamp position.

Thermal protection provided against improper lamp usage.

120 volts only.

INSTALLATION — Air-Tight housing suitable for air-tight installations.

2 x 8 wood joist or T-bar installation.

Expandable bar hangers allow for off center mounting in wood joist or T-bar ceilings.

Length of 25 1/4" maximum 13 1/4" minimum or cut to fit 9" on center joist construction.

Vertical adjustment of housing allows for flush mounting with ceiling face.

Suitable to ceilings up to 1-1/2" thick.

LISTINGS — U.L. Listed to U.S. and Canadian safety standards.

Damp location listing. (See trim selection for wet location listing).

WARRANTY — 1-year limited warranty. Complete warranty terms located at

www.acuitybrands.com/CustomerResources/Terms_and_conditions.aspx

Note: Specifications subject to change without notice.

Catalog Number
Notes
Type

6" Housing

L7X

INCANDESCENT
IC/Non-IC
New Construction

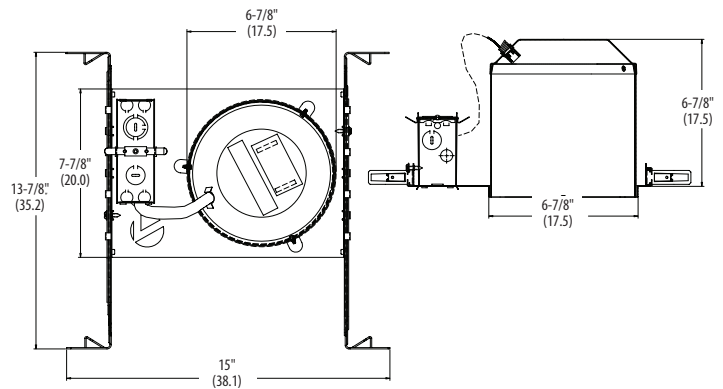

Specifications

All dimensions are inches (centimeters).

Height: 6-7/8 (17.48)

Length: 15 (38.1)

Width: 13-7/8 (35.24)

Ceiling cutout: 7 (17.8)











ORDERING INFORMATION For shortest lead times, configure product using **bolded options**. **Example: L7X R6**

Series	Options	Packaging
L7X	Shipped installed in fixture PHC Poke-home wire connectors GSKT Foam gasketing, aids in air-tight installation	R6 Resale pack of six U Unit (non-stock)

Accessories: Order as separate catalog number.	
ATK6 R6	6" Air-tight trim kit
HS6875	6-7/8" Hole saw

NOTE:
See trim summary on reverse side for maximum wattages.

L7X: 6" New Construction Housing

Description Catalog number	Maximum wattage	Description Catalog number	Maximum wattage	Description Catalog number	Maximum wattage	Description Catalog number	Maximum wattage
General/Task							
Open Narrow Flange 702A 702A PFMW TOR	Clear diffuse Clear diffuse, matte white, plastic flange Clear specular Black specular	Baffle Narrow Flange 7B2 TOR 7B2 TRMW TOR 7B2W TOR 7B2W PF TOR 7B2MW TOR 7B2BN TOR 7B2ORB TOR 7B2BZA TOR	Black Black, matte white flange White White plastic flange Matte white Brushed nickel Oil-rubbed bronze Antique bronze	Regressed Eyeball Wide Flange 7RE1	White	Shower/Closet Lens Narrow Flange 7LD1 7LD1 PF 7LD2 PF	Drop opal metal flange Drop opal plastic* Drop prismatic plastic*
702AZ 702BLZ				IC/Non-IC	65 BR30 50 PAR30		40 A19
IC/Non-IC		IC/Non-IC		Wallwash Narrow Flange 7W1	White	Shower/Closet Lens Narrow Flange 6LD1 6LD2 6LF1 6LF2	Drop opal plastic* Drop prismatic plastic* Flush opal plastic* Flush prismatic plastic*
Open Narrow Flange 702 TOR 702MW TOR 702BN TOR 702ORB TOR	White* Matte white Brushed nickel Oil-rubbed bronze	Baffle Wide Flange 7B3 TOR 7B3W TOR	Black White	Non-IC	65 BR30 75 PAR30		60 A19
IC/Non-IC		IC/Non-IC		Pinhole Narrow Flange 6S1	White	Non-IC	60 A19 65 BR30 50 R20/PAR20
Open Wide Flange 703 TOR	White	Baffle Narrow Flange 7B5 7B5W	Black White	Non-IC	65 BR30 75 PAR30	Lens/Wet Location	
IC/Non-IC		Non-IC		WETLite™ 6H20 TOR 6H20ORB TOR 6H20BZA TOR 6H20BN TOR	White Oil-rubbed bronze Antique bronze Brushed nickel	Glass Lens Narrow Flange 6LD3 6LDB3 6LF3 6LFB3 6L4 6LB4	Drop opal white splay Drop opal black baffle Flush white white splay Flush white black baffle Fresnel white splay Fresnel black baffle
Open Narrow Flange 705 705 PF 705AZ	White White plastic flange Clear specular	Accent/Adjustable Eyeball Wide Flange 7E1 TOR 7E1MW TOR 7E1BN TOR 7E1ORB TOR 7E1BZA TOR	White Matte white Brushed nickel Oil-rubbed bronze Antique bronze	Non-IC	120 BR40 150 PAR38		75 A19
Non-IC		IC/Non-IC		NOTES:			
				1 Maximum wattage listed. Lower wattage lamps may be used.			
				2 Lens trims and WETLites™ are wet location listed. All others are damp location.			
				3 Shallow trims may be used for lower lamp position. See C & 7 Series Trims.			
				4 6 and C series trims also compatible options.			

REALITY™ ENERGY STAR® (ESL) Open Narrow flange (Wet location)

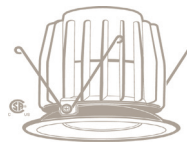

Example: REAL6 D6MW ESL 1000L 35K .60SC L7X¹

ORDERING INFORMATION

For shortest lead times, configure products using **bolded options**.

Series/Finish		ESL	Lumen output ¹	Color temperature	Distribution	Voltage	Options
Series	Finish	Type					
REAL6 D6	6" ENERGY STAR retrofit module	ESL ENERGY STAR® listed	600L 8W, 600 lumens 1000L 11W, 1000 lumens	27K 2700K 30K 3000K 35K 3500K 40K 4000K	.60SC .60 spacing criteria .90SC .90 spacing criteria	(blank) 120V	PFMW Matte white plastic flange ring PFBL Black plastic flange ring ISH Insect shield