

# ZS10-SF Screw Clamp Terminal Blocks For 6.3x32 fuses

- Protect your circuits with 6.3x32 (¼ x 1¼ in) fuse terminal blocks compliant with IEC 60947-7-3 standard (fuse not supplied with the terminal blocks),
- Simplify the distribution thanks to the two jumper channels.

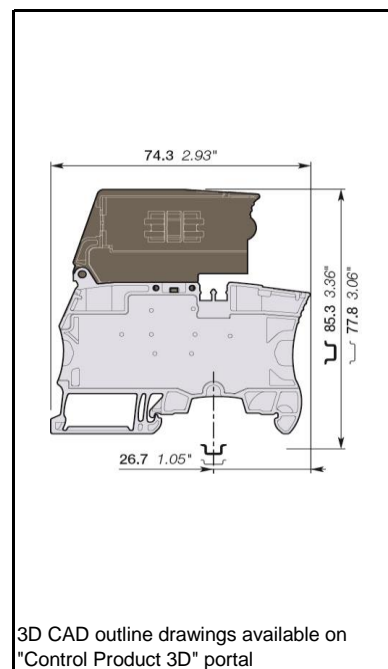

		<b>10 mm<sup>2</sup></b>
		6 AWG
<b>8 mm 0.315 in Spacing</b>		









### Ordering Details

Color	Type	Order Code	EAN Code	Pack <sup>(mg)</sup>	Weight (1 pce) g
Grey, Dark Grey	ZS10-SF	1SNK508418R0000	3472595084180	50	28.50

### Declarations and Certificates





						EAC			
CE	CB	RoHS	US	USR CNR	SA				
		BV		DNV					

## Declarations and Certificates

	CE		1SND225103U10*
	CB		1SND161089A02*
	RoHS		1SND230516F02*
	USR CNR		1SND161041A02*
	CSA		1SND161070A02*
	EAC		1SND161009A11*
	BV		1SND161073A02*
	DNV		1SND161087A02*

## General Information

The following information must be strictly adhered to in order to guarantee the terminal block electrical, mechanical and environmental performance.

Protection	IEC 60947-1	IP20		NEMA 1				
Rail		TH 35-7.5, TH 35-15						
Wire stripping length		13 mm	0.512 in					
		Screw clamp		Screw rail contact (Maximum value)		Disconnect device		
Operating tool		Flat screwdriver						
		4 mm	0.157 in					
Torque		1.3 N.m ± 0.3 N.m	11.5 N.m ± 2.65 N.m					

## Material Specifications

Insulating material	Polyamide
CTI	600 V
Flammability	UL94 V0
	NF F 16101 I2F2
	Needle flame test: C 60615-11-5
	Compliant

## Connecting capacity per clamp

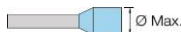
		Screw clamp			
1 Rigid - Solid / Stranded conductor	Norme				
	Value	0.5 ... 10 mm <sup>2</sup>	24 ... 6 AWG		
1 Flexible conductor	Norme				
	Value	0.5 ... 10 mm <sup>2</sup>			
1 Flexible conductor with non insulated ferrule	Norme	Manufacturer data	Manufacturer data		
	Value	0.5 ... 10 mm <sup>2</sup>	24 ... 8 AWG		
1 Flexible conductor with insulated ferrule	Norme	Manufacturer data	Manufacturer data		
	Value	0.5 ... 6 mm <sup>2</sup>	24 ... 10 AWG		
Gauge		A5-B5	5.2 mm		
		IEC 60947-1	0.205 in		
Ferrule maximum outer diameter or conductor insulation maximum outer diameter		Manufacturer data	7.5 mm		0.295 in

The "Connecting capacity with ferrule" data is guaranteed with ABB crimping tool PS-3 (crimping capacity up to 10 mm<sup>2</sup>).

As part of its on-going product improvement, ABB reserves the right to modify the characteristics or the products described in this document. The information given is not contractual. For further details please contact the ABB company marketing these products in your country.

## Multi Connecting capacity per clamp

2 Rigid - Solid / Stranded conductors	Norme			
	Value	0.5 ... 4 mm <sup>2</sup>	20 ... 12 AWG	
2 Flexible conductors	Norme			
	Value	0.5 ... 4 mm <sup>2</sup>		
2 Flexible conductors with twin ferrule	Norme	Manufacturer data	Manufacturer data	
	Value	0.5 ... 4 mm <sup>2</sup>	20 ... 12 AWG	

Don't mix **solid and flexible** conductors **in the same clamp**

Don't mix **solid or flexible** conductors of different sizes **in the same clamp**

The "Connecting capacity with ferrule" data is guaranteed with ABB crimping tool PS-3 (crimping capacity up to 10 mm<sup>2</sup>)

## Cross section

Rated cross section		10 mm <sup>2</sup>		6 AWG
Maximum Cross section	Manufacturer data	10 mm <sup>2</sup>	Manufacturer data	6 AWG

## Electrical characteristics

### Current

Rated current				10 A
	Field and factory wiring Cat.2		UL 1059	22 A
	Factory wiring Cat.1		UL 1059	22 A
			CSA-C-22.2 n°158	22 A
Maximum Exe current			IEC/EN 60079-7	
Rated short-time withstand current 1 s (I <sub>cw</sub> )				
Short-time withstand current	0.5 s	Manufacturer data		
	5 s	Manufacturer data		
	10 s	Manufacturer data		
	30 s	Manufacturer data		
	1 min	Manufacturer data		
Rated short-circuit withstand current			UL 1059	
Max. current (45° temperature increase) / Max. cross section (mm <sup>2</sup> )			Manufacturer data	25 A   10 mm <sup>2</sup>
Maximum short circuit current (1s)			Manufacturer data	

### Short Circuit Current Rating (SCCR) SA UL 1059 supplement

SCCR		UL 1059	
With the following configurations:			
Suitable conductor wire range			
Maximum voltage			
Fuse class / Max. amp. Rating		J	
		T	
		RK1	
		RK5	
		G	
		CC	

### Voltage

Rated voltage	IEC 60947-1	630 V
Rated voltage	UL 1059	600 V
Use Group	UL 1059	B,C
Rated voltage	CSA-C-22.2 n°158	600 V
Rated voltage Ex e	IEC/EN 60079-7	
Rated impulse withstand voltage	IEC 60947-1	6000 V
Dielectric test voltage	IEC 60947-1	2000 V
Pollution degree	IEC 60947-1	3
Overvoltage category	IEC 60947-1	III

## Temperature range

Ambient temperature min/max	Storage	-55 ... +110 °C	-67 ... +230 °F
	Installing	-5 ... +40 °C	+23 ... +104 °F
	Service	-55 ... +110 °C	-67 ... +230 °F

## Dissipated power

Maximum dissipated power at rated current	IEC 60947-1
Maximum dissipated power at maximum Exe current	IEC 60079-7

## Rated power dissipation at an ambient temperature of 23 °C - IEC 60947-7-3

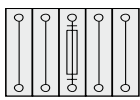
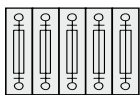
Separate arrangement / Overload and short-circuit protection	 1 fuse and 4 feed-through blocks	4
Separate arrangement / Exclusive short-circuit protection		4
Compound arrangement / Overload and short-circuit protection	 5 fuse blocks	2.5
Compound arrangement / Exclusive short-circuit protection		2.5

## Environmental Characteristics

### Additional climatic tests

Dry heat	Conditions	IEC 60068-2 2	Compliant
		Temperature	+100 °C
		Duration of test	96 h
Cyclic damp heat	Conditions	IEC 60068-2 30	Compliant
		Temperature	+55 °C
		Relative humidity	
		Number of cycles (1 cycle = 24h)	2
Cold	Conditions	IEC 60068-2 1	Compliant
		Temperature	-40 °C
		Duration of test	96 h
Damp heat steady state	Conditions	IEC 60068-2-78	
		Temperature	
		Relative humidity	
		Duration of test	

## Corrosion

Salt mist	Conditions	IEC 60068-2 11	Compliant
		Duration of test	96 h
		Concentration	5 %
SO <sub>2</sub>	Conditions	ISO 6988	Compliant
		Duration of test	48 h
		Concentration	0.2 dm <sup>3</sup>
Flowing mixed gas corrosion test	Conditions	IEC 60068-2 60	
		Number of the test method	
		Duration of test	

As part of its on-going product improvement, ABB reserves the right to modify the characteristics or the products described in this document. The information given is not contractual. For further details please contact the ABB company marketing these products in your country.



# Contact us

**ABB France**  
**Electrification Products Division**  
**PG Connection**  
3, rue Jean Perrin  
F-69687 Chassieu cedex / France  
Tel. +33 (0)4 7222 1722  
Fax +33 (0)4 7222 1935

*Note*

*We reserve the right to make technical changes or modify the contents of this document without prior notice. With regard to purchase orders, the agreed particulars shall prevail. ABB does not accept any responsibility whatsoever for potential errors or possible lack of information in this document.*

*We reserve all rights in this document and in the subject matter and illustrations contained therein. Any reproduction, disclosure to third parties or utilization of its contents – in whole or in parts – is forbidden without prior written consent of ABB.*

Copyright© 2011 ABB  
All rights reserved

1 SNK161052D0201 - PDF