

BJ Jumper bar

Use the BJ jumper bar to connect consecutive and nonconsecutive terminal blocks with the same spacing. Two types of jumper bars are available : an assembled unit and a nonassembled unit. Both jumper bars include a metal tube which makes contact with the terminal block's internal connector bar.

To mount the BJ jumper bar accessory onto terminal blocks still having top center partitions, the user must cut out all partitions between the blocks.

When the BJ jumper bar is used with each of two series of connected blocks, the top center opening at the junction of the two series must be closed by a circuit separator or a separator end section SCM, SCF or SCD to permit different voltage potentials on each series jumper bar accessory.



BJM Assembled jumper bar

Two versions of this accessory are available.

Fractionable model, composed of captive screws on a jumper bar system. This accessory can be used for connecting consecutive blocks only.

Simplified model, composed of a bar prepunched to the spacing of the blocks, and of captive screws and spacers. This accessory can be used for connecting blocks, which are consecutive or not : in this case remove the screw and spacer which are not required.

without IP20 protection (standard)



Current capacity, Amps

BJM5 for MA 2,5/5 blocks		
24 A	2 poles	0176 273.01
24 A	3 poles	0176 274.02
24 A	4 poles	0176 275.03
24 A	5 poles	0176 276.04
24 A	10 poles	0176 277.05
BJM6 for M 4/6 blocks		
32 A	2 poles	0168 516.25
32 A	3 poles	0168 517.26
32 A	4 poles	0168 518.07
32 A	5 poles	0168 519.00
32 A	10 poles	0168 973.07
BJM8 for M 6/8 blocks		
41 A	2 poles	0168 520.05
41 A	3 poles	0168 521.22
41 A	4 poles	0168 522.23
41 A	5 poles	0168 523.24
41 A	10 poles	0168 974.00

Max. recommended torque : 0.6 Nm

with IP20 protection (touchproof)



Current capacity, Amps

BJMI5 for MA 2,5/5 blocks		
24 A	2 poles	0176 278.16
24 A	3 poles	0176 279.17
24 A	4 poles	0176 280.05
24 A	5 poles	0176 281.22
24 A	10 poles	0176 282.23
BJMI6 for M 4/6 blocks		
32 A	2 poles	0176 663.00
32 A	3 poles	0176 664.01
32 A	4 poles	0176 665.02
32 A	5 poles	0176 666.03
32 A	10 poles	0176 667.04
BJMI8 for M 6/8 blocks		
41 A	2 poles	0176 669.16
41 A	3 poles	0176 670.13
41 A	4 poles	0176 671.00
41 A	5 poles	0176 672.01
41 A	10 poles	0176 673.02

Max. recommended torque : 0.6 Nm

without IP20 protection (standard)



Current capacity, Amps

BJM5D for MA 2,5/5.D blocks		
24 A	2 poles	0176 226.22
24 A	3 poles	0176 227.23
24 A	4 poles	0176 228.04
24 A	5 poles	0176 229.05
24 A	10 poles	0176 230.02
BJM6D for M 4/6.D blocks		
32 A	2 poles	0173 515.11
32 A	3 poles	0173 516.12
32 A	4 poles	0173 517.13
32 A	5 poles	0173 519.25
32 A	10 poles	0173 520.22
BJM62 for D 4/6.LNTP, DR 4/6 blocks		
32 A	2 poles	0173 217.26
32 A	3 poles	0173 218.07
32 A	4 poles	0173 219.00
32 A	5 poles	0173 221.22
32 A	6 poles	0174 112.16
32 A	7 poles	0174 113.17
32 A	8 poles	0174 114.10
32 A	9 poles	0174 115.11
32 A	10 poles	0173 226.27

BJM65 for M 4/6,5.3G blocks		
32 A	2 poles	0174 764.03
32 A	3 poles	0174 765.04
32 A	4 poles	0174 766.05
32 A	5 poles	0174 767.06
32 A	10 poles	0174 768.17
32 A	25 poles	0174 769.10

BJM10 for M 10/10 blocks		
57 A	2 poles	0173 611.21
57 A	3 poles	0173 612.22
57 A	4 poles	0173 613.23
57 A	5 poles	0173 614.24
57 A	10 poles	0173 615.25

BJM12 for M 16/12 blocks		
76 A	2 poles	0179 618.16
76 A	3 poles	0179 619.17
76 A	4 poles	0179 620.14
76 A	5 poles	0179 621.01
76 A	10 poles	0179 622.02

BJM16 for M 35/16 blocks		
110 A	2 poles	0179 613.01
110 A	3 poles	0179 614.02
110 A	4 poles	0179 615.03
110 A	5 poles	0179 616.04
110 A	10 poles	0179 617.05

BJM4 for DR 1,5/4 blocks		
17,5 A	2 poles	0205 735.06
17,5 A	3 poles	0205 736.07
17,5 A	5 poles	0205 737.00
17,5 A	10 poles	0205 738.11

Max. recommended torque : 0.6 Nm
except for BJM16 (1.2 Nm)

with IP20 protection (touchproof)



Current capacity, Amps

BJMI5D for MA 2,5/5.D blocks		
24 A	2 poles	0176 736.21
24 A	3 poles	0176 737.22
24 A	4 poles	0176 738.03
24 A	5 poles	0176 739.04
24 A	10 poles	0176 740.11
BJMI6D for M 4/6.D blocks		
32 A	2 poles	0179 668.20
32 A	3 poles	0179 669.21
32 A	4 poles	0179 670.26
32 A	5 poles	0179 671.13
32 A	10 poles	0179 672.14

BJMI10 for M 10/10 blocks		
57 A	2 poles	0176 675.04
57 A	3 poles	0176 676.05
57 A	4 poles	0176 677.06
57 A	5 poles	0176 678.17
57 A	10 poles	0176 679.10

BJMI12 for M 16/12 blocks		
76 A	2 poles	0179 626.06
76 A	3 poles	0179 628.10
76 A	4 poles	0179 629.11
76 A	5 poles	0179 630.16
76 A	10 poles	0179 631.03

BJMI16 for M 35/16 blocks		
110 A	2 poles	0179 613.01
110 A	3 poles	0179 614.02
110 A	4 poles	0179 615.03
110 A	5 poles	0179 616.04
110 A	10 poles	0179 617.05

BJM4 for DR 1,5/4 blocks		
17,5 A	2 poles	0205 735.06
17,5 A	3 poles	0205 736.07
17,5 A	5 poles	0205 737.00
17,5 A	10 poles	0205 738.11

Max. recommended torque : 0.6 Nm

BJD Assembled jumper bar

Only one version of this accessory is available

Simplified model, composed of a bar prepunched to the spacing of the blocks, and of captive screws and spacers. This accessory can be used for connecting blocks, which are consecutive or not : in this case remove the screw and spacer which are not required.

without IP20 protection



Current capacity, Amps

BJD6 for D 2,5/6.D blocks, triple deck		
24 A	2 poles	0178 024.25
24 A	3 poles	0178 025.26
24 A	4 poles	0178 026.27
24 A	5 poles	0178 027.20
24 A	10 poles	0178 032.25
24 A	20 poles	0178 033.26

Max. recommended torque : 0.6 Nm

BJ Jumper bar (cont.)

To connect terminal blocks, place the metal tube into the top center hole on each terminal block to be connected. The metal tube contacts the terminal block's internal connector bar. The perforated bar is cut to length and placed flat along the center opening of the series of terminal blocks. The screw is inserted into the perforated bar's hole which is located directly above the blocks being connected. The screw goes through the threaded metal tube and is screwed into the terminal block's internal connector bar. This completes the electrical connection to the perforated bar and connects the block.

BJS Jumper bar not assembled



Subassembly screw + post



Perforated jumper bar to be cut to length

Type of block	Type	P/N	Type	No. of poles	Current car. cap.	P/N
MA 2,5/5 DR 1,5/5	EV5	0168 629.16	BJS5	20	24 A	0177 652.06
MA 2,5/5.D	EV5D	0176 260.10	BJS5D	20	24 A	0177 651.05
M 4/6	EV6	0168 604.16	BJS6	2	32 A	0164 573.22
			BJS6	3	32 A	0164 574.23
			BJS6	4	32 A	0164 575.24
			BJS6	5	32 A	0164 736.25
			BJS6	10	32 A	0164 576.25
			BJS6	20	32 A	0174 784.20
M 4/6.D MD 2,5/6...	EV6D	0168 400.16	BJS61	2	32 A	0168 481.23
			BJS61	3	32 A	0168 482.24
			BJS61	4	32 A	0168 483.25
			BJS61	5	32 A	0168 484.26
			BJS61	10	32 A	0168 485.27
DR 4/6	EVDR6	0168 399.10	BJS62D	10	24 A	0167 601.02
M 6/8 M 6/8.ST	EV6	0168 604.16	BJS8	2	41 A	0164 581.13
	EV8S	0168 401.03	BJS8	3	41 A	0164 582.14
M 4/8.D2.SF...J	VJS11	0163 394.26	BJS8	4	41 A	0164 583.15
			BJS8	5	41 A	0164 737.26
			BJS8	15	41 A	0174 788.04
			BJS8	20	41 A	0174 789.05
M 6/9.EE			BJS9,5	2	41 A	0173 815.16
			BJS9,5	3	41 A	0173 816.17
			BJS9,5	4	41 A	0173 817.10
			BJS9,5	5	41 A	0173 818.21
			BJS9,5	10	41 A	0173 819.22
M 10/10	EV6	0168 604.16	BJS10	2	57 A	0164 585.17
			BJS10	3	57 A	0164 586.10
			BJS10	4	57 A	0164 587.11
			BJS10	5	57 A	0168 273.11
			BJS10	10	57 A	0164 588.22
			BJS10	20	57 A	0177 654.00
M 16/12	EV12	0168 664.11	BJS12	2	57 A	0164 589.23
			BJS12	3	57 A	0164 590.20
MB 10/12.SF	screw	0163 574.22	BJS12	4	57 A	0164 591.15
			BJS12	10	57 A	0164 592.16
			BJS12	20	57 A	0177 653.07
M 6/12.FF			BJS12,5	2	41 A	0174 393.20
			BJS12,5	3	41 A	0174 394.21
			BJS12,5	5	41 A	0174 395.22
			BJS12,5	10	41 A	0174 396.23
M 6/13.FF			BJS13	10	125 A	0167 224.27
ML 10/13.SF	screw	0163 394.26	BJS131	2	57 A	0179 846.03
			BJS131	10	57 A	0175 991.11
M 35/16	EV16	0179 627.07	BJS16	2	125 A	0168 241.11
			BJS16	10	125 A	0168 238.16
M 70/22	screw	0173 320.01	BJS22	2	192 A	0173 316.21
			BJS22	3	192 A	0173 317.22
			BJS22	5	192 A	0173 318.03
			BJS22	10	192 A	0173 319.04
MB 10/24.SF	screw	0163 607.04	BJS24	10	30 A	0167 856.21
M 95/26	VJS51	0173 320.01	BJS261	2	232 A	0177 508.07
			BJS261	3	232 A	0177 509.00
			BJS261	5	232 A	0177 510.24
			BJS261	10	232 A	0177 511.11

Max. recommended torque: 0.6 Nm

BJDP Universal jumper bar

This accessory permits the interconnection of two consecutive blocks with different spacings. It is composed of:

- 2 posts
- 2 screws
- 1 connector plate



Kit n°	Current carrying capacity, Amps	P/N
Kit n° I	BJDP1 50	0179 623.03
Kit n° II	BJDP2 95	0179 624.04
Kit n° III	BJDP3 70	0179 625.05
Kit n° IV	BJDP4 50	0174 781.25
Kit n° V	BJDP5 50	0174 782.26

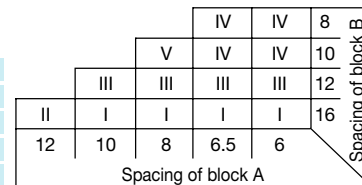

- Note:**
- spacing of block 6 corresponds to **M 4/6** and its derivatives.
 - spacing of block 6,5 corresponds to **M 4/6,5** and its derivatives.
 - spacing of block 8 corresponds to **M 6/8** and its derivatives.
 - spacing of block 10 corresponds to **M 10/10** and its derivatives.
 - spacing of block 12 corresponds to **M 16/12** and its derivatives.
 - spacing of block 16 corresponds to **M 35/16** and its derivatives.

Max. recommended torque : 0.6 mNm

BJDPL Jumper bar for spring blocks with different spacings

This accessory allows the connection of 2 spring terminal blocks with different spacings (spacing 5 and 6 mm, 6 and 8 mm, 5 and 8 mm). When using a jumper bar, it is necessary to use an end section between the interconnected blocks, whatever the mounting direction of the blocks may be.

- BJDPL 56** 0291 150.06 to connect a block of 5 mm and a block of 6 mm spacing
- BJDPL 58** 0291 160.00 to connect a block of 5 mm and a block of 8 mm spacing
- BJDPL 68** 0291 170.02 to connect a block of 6 mm and a block of 8 mm spacing

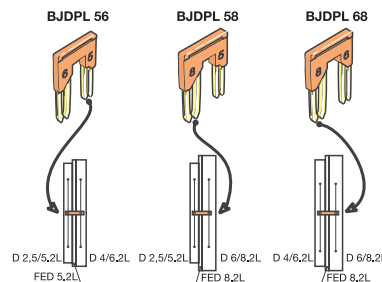

BJDL Jumper bar for spring blocks with same spacing

For blocks spacing 5 mm .200"

- BJDL5.2** 2 poles 0291 102.23
- BJDL5.3** 3 poles 0291 103.24
- BJDL5.4** 4 poles 0291 104.25
- BJDL5.5** 5 poles 0291 105.26
- BJDL5.6** 6 poles 0291 106.27
- BJDL5.7** 7 poles 0291 107.20
- BJDL5.8** 8 poles 0291 108.01
- BJDL5.9** 9 poles 0291 109.02
- BJDL5.10** 10 poles 0291 110.26

For blocks spacing 8 mm .315"

- BJDL8.2** 2 poles 0291 122.16
- BJDL8.3** 3 poles 0291 123.17
- BJDL8.4** 4 poles 0291 144.24
- BJDL8.5** 5 poles 0291 145.25

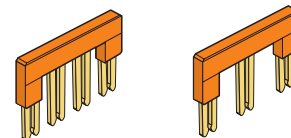

For blocks spacing 6 mm .238"

- BJDL6.2** 2 poles 0291 128.24
- BJDL6.3** 3 poles 0291 129.25
- BJDL6.4** 4 poles 0291 194.17
- BJDL6.5** 5 poles 0291 195.10

For blocks spacing 10 mm .400"

- BJDL10.2** 2 poles 0291 322.26
- BJDL10.3** 3 poles 0291 323.27
- BJDL10.4** 4 poles 0291 324.20
- BJDL10.5** 5 poles 0291 325.21

BJ Jumper bar (cont.)

BJP Pivoting jumper bar

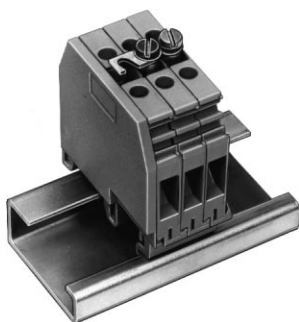

This accessory is for connecting or disconnecting two consecutive blocks, open or closed. The use of a third non-connected block is recommended to allow for a "rest" position of the rotating jumper link. We recommend the use of a circuit separator **SC** in order to preserve the insulation. The **BJP** is mounted in the center of the terminal blocks, the connector bars of which are tapped for receiving the interconnection accessories.



Current capacity

- For blocks with 6 mm .238" spacing
BJP6 35 A **0174 413.14**
 - For double deck blocks with 6 mm .238" spacing
BJP61 35 A **0167 225.20**
 - For blocks with 8 mm .315" spacing
BJP8 50 A **0174 448.07**
 - For blocks with 10 mm .394" spacing
BJP10 70 A **0174 451.22**
 - For double deck blocks with 8 mm .315" spacing
BJP82 50 A **0163 169.04**
 - For blocks DR 4/6 with 6 mm .238" spacing
BJPD6 35 A **0173 223.24**
- Max. recommended torque : 0.6 Nm

BJA Jumper bar for alternated jumping

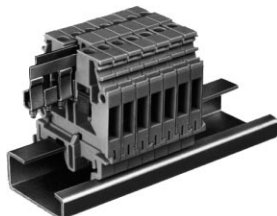

This accessory permits the interconnection of consecutive or nonconsecutive blocks. For this, detach the studs manually where connection is not required. The use of two bars permits alternated jumping. A captive screw is mounted on each stud. This jumper bar is delivered with a protective cover snapped onto the top of the block, assuring touch proof protection.



Jumper bar assembly (protective cover included) :

- For blocks with 5 mm .200" spacing
BJA5 24 A 10 poles **0205 021.26**
- For blocks with 6 mm .238" spacing
BJA6 35 A 10 poles **0116 541.12**
BJA6 35 A 30 poles **0116 589.13**

Protective cover, 10 poles :

- For **BJA5** grey **0119 847.20**
- For **BJA6** grey **0116 508.22**
white **0103 819.25**

Note : At each extremity of the jumpers, the assembly must be insulated. For this, use either a closed block or a circuit separator **SC**.

BJADO Screwless jumper bar for mini ADO and ADO blocks spacing 5 or 6 mm only

This accessory permits the interconnection of consecutive or nonconsecutive blocks. For this, detach the studs manually where connection is not required. Due to this flexible connection system, the contact is made by a simple insertion into the ADO jaw. 2 wire connection is permitted. Protection : NEMA 1 Marking with RCT 610 and RCT 810 markers (marking mode 21).

* Important : It is necessary to remove the jumper bar to access the wiring.

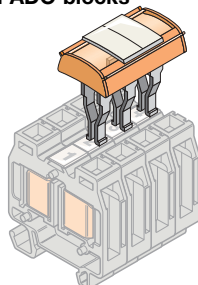

- For ADO blocks spacing 5 mm .200"
BJADO5.2 2 poles **0205 955.03**
BJADO5.3 3 poles **0205 956.04**
BJADO5.4 4 poles **0205 957.05**
BJADO5.5 5 poles **0205 958.16**
BJADO5.10 10 poles **0205 963.03**
BJADO5.20 20 poles **0205 973.05**
 - For ADO blocks spacing 6 mm .238"
BJADO6.2 2 poles **0205 974.06**
BJADO6.3 3 poles **0205 975.07**
BJADO6.4 4 poles **0205 976.00**
BJADO6.5 5 poles **0205 977.01**
BJADO6.10 10 poles **0205 982.27**
BJADO6.20 20 poles **0205 992.21**
- Current capacity : 13,5 A Current capacity : 17,5 A

BJE Jumper bar without screw

✓ for compression clamp and ADO blocks

This accessory permits the interconnection of consecutive or nonconsecutive blocks. For this, detach the studs manually where connection is not required. Due to its flexible connection system, the contact is made by a simple insertion into the central hole of the current bar. Easy indication of the non-connected blocks : simply cut out the notches placed on top of the plastic body of the jumper bar (orange color). Marking with adhesive markers **RB5A** (marking mode 21). Compatible with test plug **FC2**.

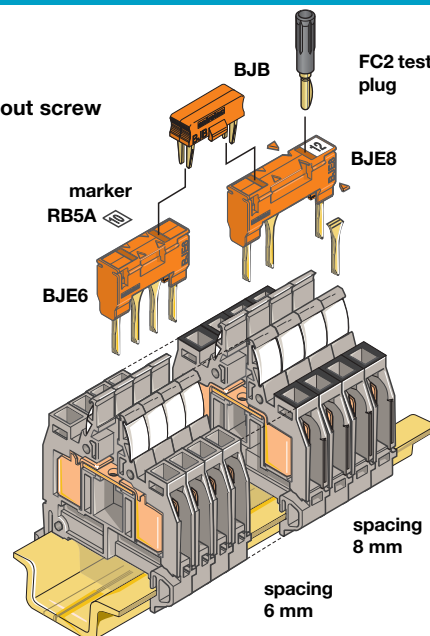

For the mounting of these accessories on blocks with partitions, cut out the partition between two interconnected blocks.

- | BJE6 | | | BJE8 | | |
|-------------------------------|----------|--------------------|-------------------------------|----------|--------------------|
| For blocks spacing 6 mm .238" | | | For blocks spacing 8 mm .315" | | |
| BJE6.2 | 2 poles | 0299 694.04 | BJE8.2 | 2 poles | 0299 712.05 |
| BJE6.3 | 3 poles | 0299 695.05 | BJE8.3 | 3 poles | 0299 713.06 |
| BJE6.4 | 4 poles | 0299 696.06 | BJE8.4 | 4 poles | 0299 714.07 |
| BJE6.5 | 5 poles | 0299 697.07 | BJE8.5 | 5 poles | 0299 715.00 |
| BJE6.6 | 6 poles | 0299 698.10 | BJE8.6 | 6 poles | 0299 716.01 |
| BJE6.7 | 7 poles | 0299 699.11 | BJE8.7 | 7 poles | 0299 717.02 |
| BJE6.8 | 8 poles | 0299 700.26 | BJE8.8 | 8 poles | 0299 718.13 |
| BJE6.9 | 9 poles | 0299 701.13 | BJE8.9 | 9 poles | 0299 719.14 |
| BJE6.10 | 10 poles | 0299 702.14 | BJE8.10 | 10 poles | 0299 720.11 |
- Current capacity : 32 A Current capacity : 41 A

Short duration current capacity : 300 A/1s
Touch proof : IP20
Fire resistance : UL94 V0

Compatible with following terminal blocks :

- M 4/6 ■ M 6/8.D2 ■ D 2,5/8.ADO ■ D 4/6.ADO.T2
- M 4/6.1 ■ 6/8.D2.1 ■ D 2,5/8.ADO.1 ■ D 4/8.ADO
- M 4/6.T ■ D,5/6.ADO ■ D 4/6.ADO ■ D 6/8.ADO
- M 6/8 ■ D 1,5/6.ADO.1 ■ D 4/6.ADO.1 ■ D 6/8.ADO.1
- M 6/8.1 ■ D 1,5/6.D2.ADO ■ D 4/6.D2.ADO ■ D 6/8.ADO3
- D 1,5/6.D2.ADO.1 ■ D 4/6.D2.ADO.1

✓ for MA 2,5/5, MA 2,5/5.1*, D 1/5.ADO and D 2,5/5.ADO blocks

- #### BJE5
- BJE5.2** 2 poles **0199 227.23**
 - BJE5.3** 3 poles **0199 228.04**
 - BJE5.4** 4 poles **0199 298.03**
 - BJE5.5** 5 poles **0199 299.04**
 - BJE5.6** 6 poles **0299 861.03**
 - BJE5.7** 7 poles **0299 862.04**
 - BJE5.8** 8 poles **0299 863.05**
 - BJE5.9** 9 poles **0299 864.06**
 - BJE5.10** 10 poles **0199 443.24**

Current capacity : 20 A
Marking with adhesive markers
* Cut out the partition for mounting of this accessory

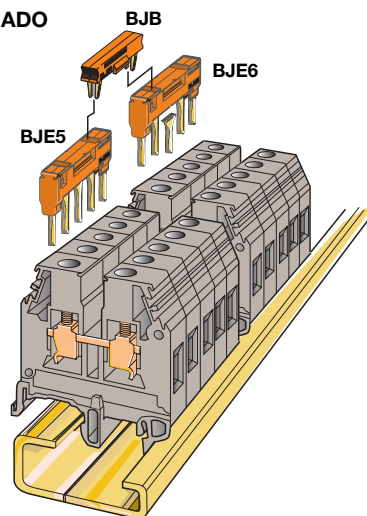

This accessory permits connecting several BJE 5, BJE6, or BJE8 beyond 10 poles and to connect 1 BJE6 with 1 BJE8 (different spacings).

- BJB** **0199 466.23**

AD

**IDC jumper
(insulation displacement jumper)**

AD 2,5

Quick-jump lets you interconnect screw clamp terminals of different sizes, levels, and all manufacturers quickly and safely. Its insulation displacement technology makes it easy to use, fast, economical and does not require a special tool. Use as a jumper between relays, switches, and other electronic components. Entrelec Quick-jump will fit any screw clamp type terminal block, from 6 mm .238" spacing and larger.

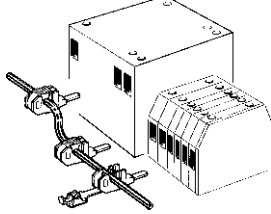

AD 2,5

0114 205.20



Characteristics

Wire size

	IEC		UL	CSA
	NFC	DIN		
Solid wire	2,5 mm ²			14 AWG
Stranded wire	2,5 mm ²			14 AWG

Voltage

Rated	600 V	600 V
Pulse		
Pollution degree		

Current

Rated	26 A	15 A
-------	------	------

Wire size

Rated / Gauge	2,5 mm ²	14 AWG
---------------	---------------------	--------

	Working temperature		Protection
	-55°C to +110°C		IP 20
	-55°C to +110°C		NEMA 1

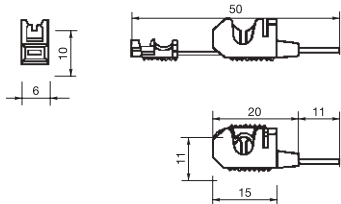

How to use : connecting Quick-jump to your terminal

- 1 - Insert Entrelec Quick-jump into your terminal screw clamp.
- 2 - Tighten the terminal screw.
- 3 - Guide jumper wire through the V-shaped opening in the Quick-jump.
- 4 - Secure the wire by closing the Quick-jump lever with any flat nose pliers.

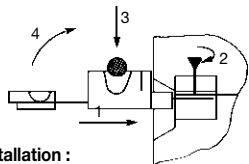

Adding a shunt in an installation :

- 1 - Insert Entrelec Quick-jump into your terminal screw clamp.
- 2 - Guide the terminal screw clamp into contact with the wire.
- 3 - Secure the wire by closing the Quick-jump lever with any flat nose pliers.
- 4 - Tighten the terminal screw.

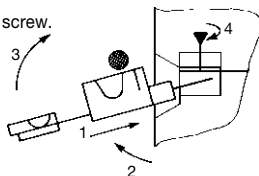

PC

Comb-type jumper bar

PC

EIP

This accessory can be used only on terminal blocks with at least one compression clamp connection. It permits the electrical connection of 2 to 10 blocks.

Interconnection of nonconsecutive blocks is possible by removing the teeth opposite the blocks which must not be connected. The comb-type jumper bars can be cut using pliers (or a saw) : in this case, the use of an insulating tip **EIP** is recommended where possible ; otherwise, use an **SCF** separator or **FE** end section between two series of interconnected blocks in order to preserve insulation. The comb is placed in the compression clamp before tightening the screws, above the eventual conductor.

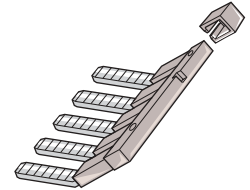
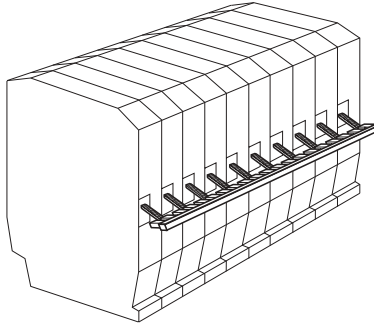
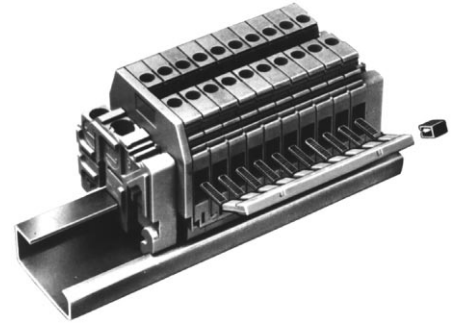

To be mounted on blocks	Insulating tip for comb		Comb-type jumper bar			
	Type	P/N	No. of poles	Type	Current	P/N
MA 2,5/5...	EIP	0113 550.24	2	PC5	30 A	0113 542.10
MA 2,5/5.D...			10	PC5	30 A	0113 544.12
DR 1,5/5...			10	PC51		0167 908.06
M 4/6 - MS 4/6 - M 4/6.H	EIP	0113 550.24	2	PC6	35 A	0113 546.14
M 1,5/6.HH - M 4/6.M2			3	PC6	35 A	0116 536.05
M 4/6.G			4	PC6	35 A	0116 537.06
			10	PC6	35 A	0113 548.26
M 4/6.D - M4/6.S...			10	PC61	35 A	0163 311.22
DR 4/6, DR 2,5/6, DRP 4/6						
M 6/8 - M 6/8.S...			2	PC8	50 A	0116 538.17
			3	PC8	50 A	0116 539.10
			4	PC8	50 A	0116 540.25
			10	PC8	50 A	0163 313.24
M 4/8.S...			10	PC81	35 A	0173 523.11
M 10/10			10	PC10	70 A	0163 315.26
M 10/13.S...			10	PC13	70 A	0173 510.20
MB 10/22.S...			3	PC22	70 A	0205 295.06
			10	PC22	70 A	0174 151.25
M 10/16.SF	EIP	0113 550.24	2	PC16	70 A	0116 729.26
			3	PC16	70 A	0116 733.12
			4	PC16	70 A	0116 734.13
			10	PC16	70 A	0116 735.14
Series 7 000 or 8 000			10	PC9	15 A	0210 160.12

BP8.A4

Bridging plug

This accessory permits electrical connection of 2 identical juxtaposed blocks. These blocks have 8 mm / .315" spacing, are equipped with a test socket dia 4 / .16".

BP8.A4

0173 888.20

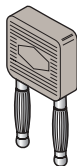

BNSTP...

Short-circuiting plug

Shunt equipped with 2 plugs dia. 4 mm / .16" for ES16 and M6/8.STP blocks.
Rated voltage : 600 V
Rated current : 20 A
2 versions available :

✓ with test socket dia. 4 mm / .16" :

Light ivory

BNSTP1 **0196 792.17**

Grey

BNSTP1 **0196 793.10**

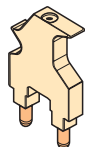

✓ without test socket:

Red

BNSTP2 **0196 789.24**

Grey

BNSTP2 **0196 790.21**



CB

Shield connector



Delivered separately, this bar of treated brass is mounted in the lower part of the terminal block. It ensures the continuity of the shield connection. The connection to the shield connector can be made either by soldering or by 2,8x0,5 mm or 2,8x0,8 mm quick connect tabs.

Notch available for bridging all shieldings. This accessory overlaps on each side of the block by about 13,5 mm.

Use of this bar reduces insulation between terminal and ground, working voltage must be derated (consult us if necessary).

CBD5.2L	0291 077.24
CBM5D	0173 530.24
CBD2S	0178 408.14
CBD2	0179 635.07
CBD1	0179 634.06
CBM8	0178 746.15
CBM5	0178 745.14

EP

Protection label

Indicates live circuits, prohibiting access to the connection screws. This accessory also protects the connections from dust and from touch.

EP...

Covers 3 or 4 blocks.

The color of the label is yellow with a red arrow. It can be fixed using 2 nylon screws (VSP ...) to be ordered separately.

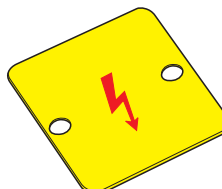
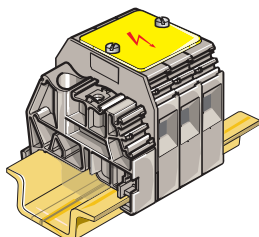

Type of blocks	Number of blocks	Type	Part number	Type	Part number
M 4/6	4	EP6	0163 427.17	VSP6	0163 433.15
M 6/8	3	EP6	0163 427.17	VSP6	0163 433.15
	4	EP8	0163 428.20	VSP6	0163 433.15
M 10/10	3	EP8	0163 428.20	VSP6	0163 433.15
	4	EP10	0163 429.21	VSP6	0163 433.15
M 16/12	3	EP10	0163 429.21	VSP12	0163 432.14
	4	EP12	0163 430.26	VSP12	0163 432.14
M 35/16	3	EP12	0163 430.26	VSP16	0173 147.20
	4	EP16	0163 431.13	VSP16	0173 147.20
M 70/22	3	EP223	0173 327.24	VSP22	0173 323.20
	4	EP224	0173 328.05	VSP22	0173 323.20

EPU ...

Covers 1 block.

The color of the label is yellow with a black arrow, to be snapped directly on the terminal block.

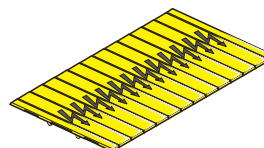
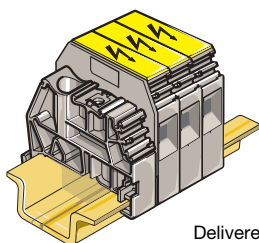

Delivered in cards of 12 labels.

Type of blocks	Type	Part number
MA 2,5/5	EPU5	0107 033.10
M 4/6, M 6/8, M 10/10, M 16/12*	EPU6	0107 038.25

(*) : use 2 labels EPU 6 for blocks spacing 12 mm.

VSP

Screw for protection label

VSP...

Two nylon screws used to hold down one protection label. Each is installed into the tapped hole on each of the two outside blocks.

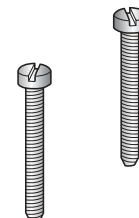

EL

Connector plate

This accessory is used for connecting electrically : two assembled interconnections with same spacing or two assembled interconnections with different spacings. Use only between the 5 mm .200" spacing, 6 mm .238" spacing and 8 mm .315" spacing blocks



EL6 **0173 627.21**
EL61 **0177 812.17**

For **D 2,5/6.D...** blocks

Current carrying capacity : 35 A

