

**Pressure sensor**  
with current output and PNP/NPN transistor switching output  
output 2 reprogrammable as switching output  
**PS250R-303-LI2UPN8X-H1141**

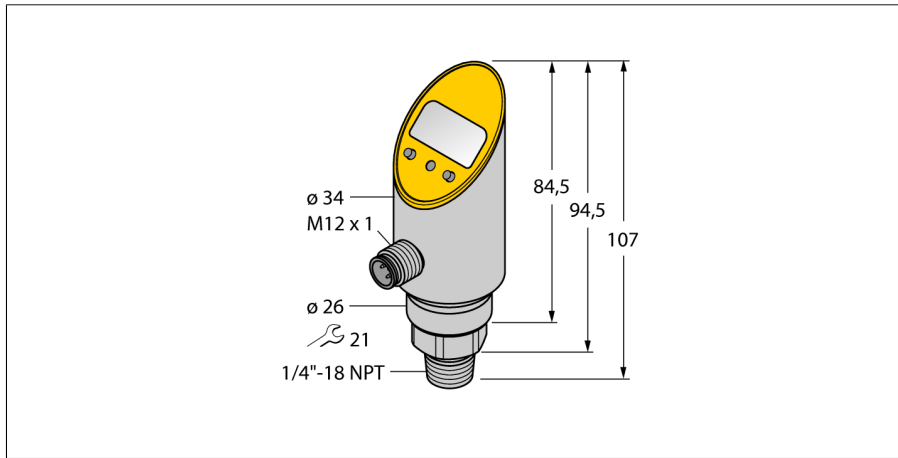

- Rigid process connection, non-rotatable body
- Reading of adjusted values without tool
- Recessed pushbutton and keylock for secure programming
- Permanent indication of pressure (bar, psi, kPa, MPa, misc)
- Peak pressure memory
- Pressure range 0 ... 250 bar rel.

**Wiring Diagram**

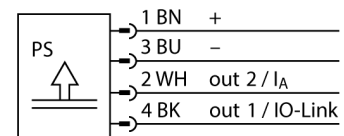

**Functional principle**

The pressure sensors of the PS series operate with piezo-resistive ceramic measuring cells. The ceramic diaphragm is unbalanced in proportion to the pressure applied. Depending on the sensor type, the voltage produced is made available either as switching or analog output signal. Non-rotatable and rotatable sensors, numerous thread types, front-flush or dead-zone free diaphragms and an accuracy of 0.5% of full scale guarantee highest flexibility and safe process interfacing.

<b>Type designation</b>	PS250R-303-LI2UPN8X-H1141
Ident no.	6833411
<b>Relative pressure</b>	0...250 bar rel.
Operating range	0...3626psi
Operating range	0...25MPa
Admissible overpressure	≤ 600 bar
Burst pressure	≥ 600 bar
Response time	< 3 ms
<b>Power supply</b>	
Operating voltage	18... 30VDC
Current consumption	≤ 50 mA
Voltage drop at I <sub>e</sub>	≤ 2 V
Protective measure	SELV; PELV according to EN 50178
Short-circuit/reverse polarity protection	yes/ yes
Protection type and class	IP67/IP69K/ III
<b>Outputs</b>	
Output 1	Switching output or IO-Link mode
Output 2	analog or switching output
<b>Switching output</b>	
Output function	NO/NC , PNP/NPN
Accuracy switching output	± 0.5 % v. E. BSL
Rated operational current	0.2 A
Switching frequency	≤ 180 Hz
Switching point distance	≥ 0.5 %
Switch point:	(min + 0.005 x range) up to 100% f.s.
Release point(s)	min up to (SP - 0.005 x range)
Switching cycles	≥ 100 mil.
<b>Analogue output</b>	
Current output	4...20mA
Operating range	4...20/ 0...20 mA (3-wire)
Load	≤ 0.5 kΩ
Accuracy LHR analog output	± 0.5 % of final value BSL
<b>IO-Link</b>	
IO-Link Specification	Specified acc. to version 1.0
Programming	FDT / DTM
Transmission physics	corresponds to 3-wire physics (PHY2)
Transmission rate	COM 2 / 38.4 kbps
Process data width	16 bit
Measured value information	14 bit
Switchpoint information	2 bit
Frame type	2.2
Genauigkeit	± 0.5 % of final value BSL

**Pressure sensor  
with current output and PNP/NPN transistor switching output  
output 2 reprogrammable as switching output  
PS250R-303-LI2UPN8X-H1141**

---

**Temperature behaviour**

Medium temperature	-40...85 °C
Temperature coefficient zero point $T_{k0}$	$\pm 0.15$ % of full scale/10 K
Temperature coefficient span $T_{\Delta s}$	$\pm 0.15$ % of full scale / 10 K

---

**Ambient conditions**

Ambient temperature	-40...80 °C
Storage temperature	-40...+80°C
Vibration resistance	20 g (9...2000 Hz), according to IEC 68-2-6
Shock resistance	50 g (11 ms) , according to IEC 61508
EMC	EN 61000-4-2 ESD:4 kV CD / 8 kV AD EN 61000-4-3 HF radiated: 15 V/m EN 61000-4-4 Burst: 2 kV EN 61000-4-5 Surge: 1000 V, 42 Ohm EN 61000-4-6 HF cable bound: 10 V

---

**Housing**

Housing material	Stainless-steel/Plastic, V2A (1.4305)
Pressure connection material	Stainless steel A2 1.4305 (AISI 303)
Pressure transducer material	Ceramics Al <sub>2</sub> O <sub>3</sub>
Sealing material	FPM spez.
Process connection	NPT 1/4" - 18 male thread
Wrench size pressure connection / coupling nut	21
Electrical connection	Flange connector, M12 x 1
Max. tightening torque housing nut	35 Nm

---

**Reference conditions acc. to IEC 61298-1**

Temperature	15...25 °C
Atmospheric pressure	860...1060 hPa abs.
Humidity	45...75 % rel.
Auxiliary power	24 VDC

---

**Display**

	4-digit 7-segment display, rotatable by 180°, disengageable
Switching state	LED yellow
Programming options	start/end value analog output; switch/release points; PNP/NPN; NO/NC contact; hysteresis/window mode; damping; pressure unit; peak pressure memory
Unit display	5 x LEDs green (bar, psi, kPa, MPa, misc)

**Pressure sensor  
with current output and PNP/NPN transistor switching output  
output 2 reprogrammable as switching output  
PS250R-303-LI2UPN8X-H1141**

**Accessories**

Type code	Ident no.	Description
PTS-Cover	6907410	Protective cap

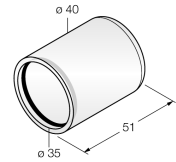

**Wiring accessories**

Type code	Ident no.	Description
RKC4.4T-2/TEL	6625013	Connection cable, female M12, straight, 4-pin, cable length: 2 m, sheath material: PVC, black; cULus approval; other cable lengths and qualities available, see www.turck.com
WKC4.4T-2/TEL	6625025	Connection cable, female M12, angled, 4-pin, cable length: 2 m, sheath material: PVC, black; cULus approval; other cable lengths and qualities available, see www.turck.com
RKC4.4T-2/TXL	6625503	Connection cable, female M12, straight, 4-pin, cable length: 2 m, sheath material: PUR, black; cULus approval; other cable lengths and qualities available, see www.turck.com
WKC4.4T-2/TXL	6625515	Connection cable, female M12, angled, 4-pin, cable length: 2 m, sheath material: PUR, black; cULus approval; other cable lengths and qualities available, see www.turck.com

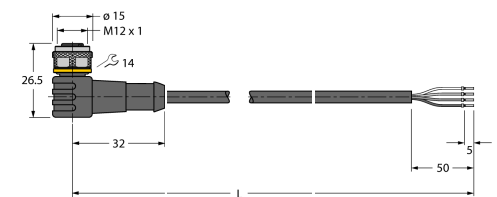
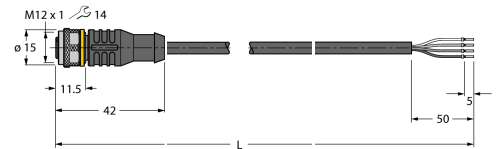
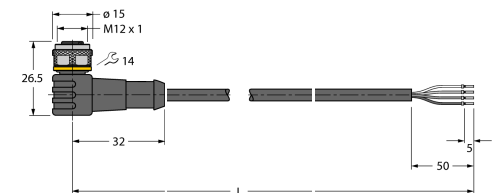
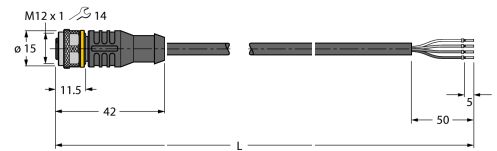

**Pressure sensor  
with current output and PNP/NPN transistor switching output  
output 2 reprogrammable as switching output  
PS250R-303-LI2UPN8X-H1141**

**Wiring accessories**

Type code	Ident no.	Description	
RKC4.4T-P7X2-10/TXL	6626184	Connection cable, female M12, angled, 4-pin, cable length: 10m, sheath material: PUR, black; cULus approval; other cable lengths and qualities available, see <a href="http://www.turck.com">www.turck.com</a>	