

- Threaded barrel, M8 x 1
- Stainless steel, 1.4427 SO
- Factor 1 for all metals
- Protection class IP68
- Resistant to magnetic fields
- Extended temperature range
- High switching frequency
- DC 3-wire, 10...30 VDC
- NO contact, PNP output
- M8 x 1 male connector

**Wiring Diagram**

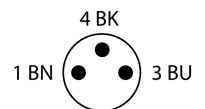
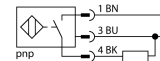

<b>Type designation</b>	NI4U-EG08-AP6X-V1131
Ident no.	4600620
<b>Rated switching distance Sn</b>	4 mm
Mounting conditions	non-flush
Assured switching distance	≤ (0,81 x Sn) mm
Repeatability	≤ 2 % of full scale
Temperature drift	≤ ± 10 %
Hysteresis	≤ ± 15 %, ≤ -25 °C v ≥ +70 °C
Ambient temperature	3...15 % -30...+85 °C
<b>Operating voltage</b>	10... 30VDC
Residual ripple	≤ 10 % U <sub>ss</sub>
DC rated operational current	≤ 150 mA
No-load current I <sub>0</sub>	≤ 15 mA
Residual current	≤ 0.1 mA
Rated insulation voltage	≤ 0.5 kV
Short-circuit protection	yes/ cyclic
Voltage drop at I <sub>0</sub>	≤ 1.8 V
Wire breakage / Reverse polarity protection	yes/ complete
Output function	3-wire, NO contact, PNP
Protective insulation	☐
Switching frequency	2 kHz
<b>Construction</b>	Threaded barrel, M8 x 1
Dimensions	49 mm
Housing material	Stainless steel, 1.4427 SO
Active area material	Plastic, PA12-GF30
Max. tightening torque housing nut	5 Nm
Electrical connection	Flange connector, M8 x 1
Vibration resistance	55 Hz (1 mm)
Shock resistance	30 g (11 ms)
Protection class	IP68
MTTF	874 years acc. to SN 29500 (Ed. 99) 40 °C
<b>Switching state</b>	LED yellow

**Functional principle**

Inductive sensors detect metal objects contactless and wear-free. *uprox®* Factor 1 sensors have significant advantages due to their patented ferrite-coreless multicoil system. They detect all metals at the same large switching distance and are resistant to magnetic fields.

**Inductive sensor  
NI4U-EG08-AP6X-V1131**

---

Distance D	32 mm
Distance W	12 mm
Distance T	32 mm
Distance S	12 mm
Distance G	24 mm
Distance N	8 mm

---

**Diameter of the active area B**                       $\varnothing$  8 mm

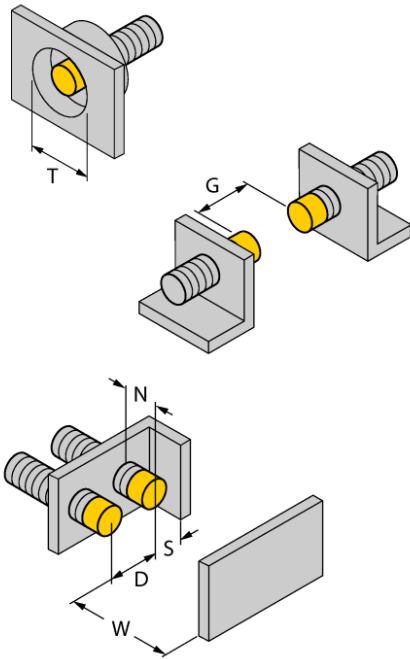

**Accessories**

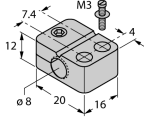
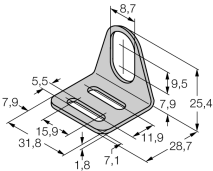
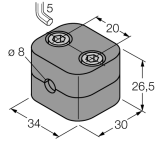
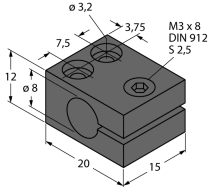
Type code	Ident no.	Description	
BST-08B	6947210	Fixing clamp for threaded barrel devices, with dead-stop; material: PA6	
MW-08	6945008	Mounting bracket for threaded barrel devices; material: Stainless steel A2 1.4301 (AISI 304)	
BSS-08	6901322	Mounting bracket for smooth and threaded barrel devices; material: Polypropylene	
MBS80	69479	Mounting bracket for threaded barrel devices; material mounting block: Anodized aluminium	

**Wiring accessories**

Type code	Ident no.	Description	
PKG3M-2/TEL	6625385	Connection cable, female M8, straight, 3-pin, stainless steel coupling nut, cable length: 2 m, sheath material: PVC, black; cULus approval; other cable lengths and qualities available, see <a href="http://www.turck.com">www.turck.com</a>	