

**Inductive sensor
With analog output
BI15-M30-LIU**

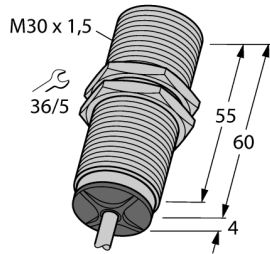

- Threaded barrel, M30 x 1.5
- Chrome-plated brass
- 4-wire, 15...30 VDC
- Analog output
- 0...10 V and 0...20 mA
- Cable connection

Wiring Diagram

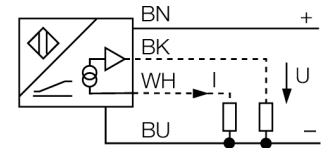

Functional principle

Inductive TURCK sensors with analog output accomplish simple control tasks. They provide a current, voltage or frequency signal proportional to the target's distance. The output signal is linear to the distance of the target over the entire sensing range.

Measuring Range

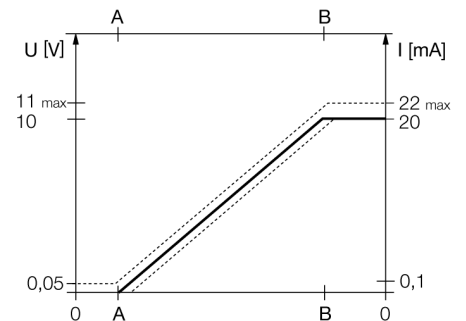

Type designation	BI15-M30-LIU
Ident no.	1535543
Measuring range [A...B]	2...10 mm
Mounting conditions	flush
Correction factors	St37 = 1; Al = 0.3; stainless steel = 0.7; Ms = 0.4
Repeatability	≤ 1 % of measuring range A - B
	≤ 0.5 %, after warm-up 0.5 h
Reproducibility	≤ 80 μm
	≤ 40 μm, after a warm-up time of 0.5 h
Linearity deviation	≤ 5 %
Temperature drift	≤ ± 0.06 % / K
Ambient temperature	-25...+70 °C
Operating voltage	15... 30VDC
Residual ripple	≤ 10 % U _{ss}
No-load current I ₀	≤ 8 mA
Rated insulation voltage	≤ 0.5 kV
Short-circuit protection	yes
Wire breakage / Reverse polarity protection	no/ complete
Output function	4-wire, Analog output
Voltage output	0...10VDC
Current output	0...20mA
Load resistance voltage output	≥ 4.7 kΩ
Load resistance, current output	≤ 0.4 kΩ
Measuring sequence frequency	140 Hz
Construction	Threaded barrel, M30 x 1.5
Dimensions	64 mm
Housing material	Metal, CuZn, chrome-plated
Active area material	Plastic, PA12-GF30
End cap	Plastic, EPTR
Max. tightening torque housing nut	75 Nm
Electrical connection	cable
Cable quality	5.2 mm, LifYY, PVC, 2m
Cable cross section	4 x 0.34 mm ²
Vibration resistance	55 Hz (1 mm)
Shock resistance	30 g (11 ms)
Protection class	IP67
MTTF	751 years acc. to SN 29500 (Ed. 99) 40 °C

**Inductive sensor
With analog output
BI15-M30-LIU**

Distance D	60 mm
Distance W	27 mm
Distance T	3 x B
Distance S	45 mm
Distance G	54 mm
<hr/>	
Diameter of the active area B	Ø 30 mm

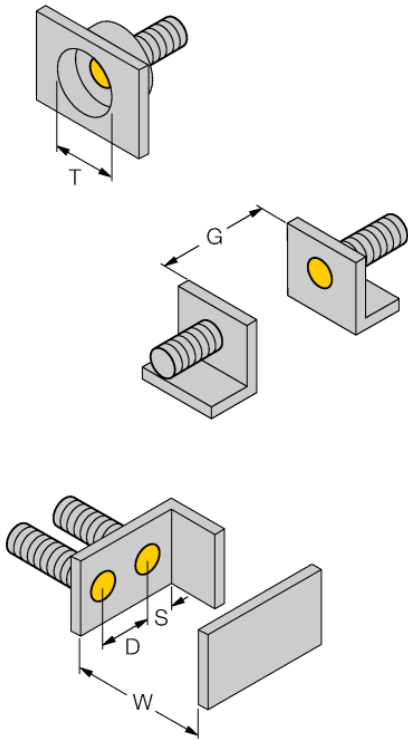

**Inductive sensor
With analog output
BI15-M30-LIU**

TURCK

Industrial
Automation

Accessories

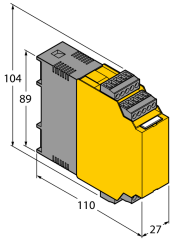
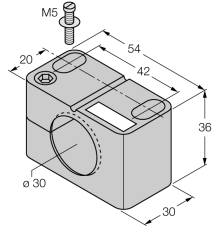
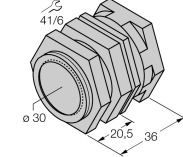
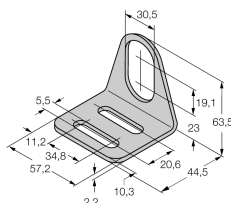
Type code	Ident no.	Description	
IM43-13-SR	7540041	Trip amplifier; 1-channel; input 0/4...20 mA or 0/2...10 V; supply of 2- or 3-wire transmitters/sensors; limit value adjustment via teach button; three relay outputs with one NO contact each; removable terminal blocks; 27 mm wide; universal voltage supply 20...250 VUC; further Limit value indicators are described in our "Interface Technology" catalog.	
BST-30B	6947216	Fixing clamp for threaded barrel devices, with dead-stop; material: PA6	
QM-30	6945103	Quick-mount bracket with dead-stop; material: Chrome-plated brass Male thread M36 x 1.5. Note: The switching distance of proximity switches can be reduced by the use of quick-mount brackets.	
MW-30	6945005	Mounting bracket for threaded barrel devices; material: Stainless steel A2 1.4301 (AISI 304)	
BSS-30	6901319	Mounting bracket for smooth and threaded barrel devices; material: Polypropylene	